

# Cardiovascular and Thoracic Surgery



*serving healthcare worldwide*



**RUDOLF MEDICAL** GmbH + Co. KG  
Postfach 28 · 78565 Fridingen, Germany  
Zollerstraße 1 · 78567 Fridingen, Germany  
Phone +49 (74 63) 99 56-0 · Fax +49 (74 63) 99 56-56  
mail@rudolf-med.com · www.rudolf-med.com



**HERZ-THORAX- UND GEFÄSSCHIRURGIE  
CARDIOVASCULAR AND THORACIC  
SURGERY  
CIRUGÍA CARDIOVASCULAR Y TORÁCICA  
CHIRURGIE CARDIOVASCULAIRE ET  
THORACIQUE  
CHIRURGIA CARDIOVASCOLARE E  
TORACICA**



Alle Produkte, deren Katalognummern mit TI enden sind aus Rein-Titan hergestellt. Die entsprechenden Katalognummern sind farblich gekennzeichnet. Titan-Instrumente bieten insbesondere im Bereich der Herzchirurgie große Vorteile. Da Titan 45% leichter als rostfreier Stahl ist, sind die daraus hergestellten Instrumente weit weniger traumatisierend. Titan ist absolut korrosionsbeständig. Die Anwendung von Titan bei der Herstellung von feinen und grazilen Instrumenten ermöglicht präzises und feinfühliges Arbeiten mit delikaten, flexiblen Produkten und bedeutet daher mehr Komfort für den Chirurgen. Ein weiterer Vorteil von Titan ist, daß das Material absolut antimagnetisch ist. Titan-Instrumente können von uns jederzeit repariert werden.

All items with a reference number ending with TI are made of pure titanium. These special catalogue numbers are colour-marked. Titanium instruments offer great advantages, especially in cardiovascular surgery. One of them is that titanium is 45% lighter than stainless steel, therefore the instruments are much more trauma-reducing. Furthermore, titanium guarantees a more precise and sensitive working and therefore more comfort for the surgeon. Titanium is absolutely antimagnetic and the instruments made of titanium can be repaired every time by RUDOLF.

Todos los productos cuyas referencias terminan en TI son fabricados de puro titanio. Las referencias correspondientes son marcadas de color. El instrumental de titanio ofrece grandes ventajas, sobre todo en el sector de la cirugía cardiovascular. Puesto que el titanio es un 45% más ligero que acero inoxidable, el instrumental fabricado de titanio disminuye el riesgo de lesiones. El titanio es absolutamente anticorrosivo. La utilización de titanio en la fabricación de instrumental fino y delicado posibilita un trabajo preciso y sensible con productos delicados y más flexibles y esto significa más confort para el cirujano. Otra ventaja de titanio es que el material es totalmente antimagnetizado. Los instrumentos de titanio siempre pueden ser reparados por nosotros.

Tous les produits avec un No d'article se terminant par TI sont fabriqués en pur titane. Les No d'articles sont marqués en couleur. Les instruments en titane offrent de grands avantages, particulièrement dans le domaine de la chirurgie cardio-vasculaire. Le titane est 45% plus léger que l'acier inox et, de ce fait, moins traumatisant. Le titane est totalement résistant à la corrosion et amagnétique. L'utilisation du titane pour des instruments fins et délicats procure au chirurgien un confort qui permet un travail précis et d'une grande sensibilité. Tous les instruments en titane sont réparables par Rudolf.

Tutti i prodotti con un numero d'articolo che termina con TI sono fabbricati in titanio puro. I numeri d'articolo sono marcati in colore. Gli strumenti in titanio offrono grandi vantaggi in particolare modo nel campo della chirurgia cardiovascolare. Il titanio è del 45% più leggero dell'acciaio inox, quindi meno traumatizzante. Il titanio è totalmente resistente alla corrosione ed amagnetico. L'uso del titanio per strumenti fini e delicati permette al chirurgo di lavorare con precisione e con una grande sensibilità. Tutti gli strumenti in titanio possono essere riparati presso la Rudolf.



0,6 mm



0,5 mm



0,4mm



0,2 mm – 0,3 mm



glatt  
smooth  
lisa  
lisse  
liscie



**Rudolf**  
**MIKRO-GRIP**

|   |          |
|---|----------|
| Wir empfehlen Hartmetall-Maulteile mit glatter Fläche und Mikro-Grip für Nahtmaterial | 9/0-11/0 |
| mit Teilung 0,2 mm – 0,3 mm und Mikro-Grip für Nahtmaterial                           | 6/0-10/0 |
| mit Teilung 0,4 mm für Nahtmaterial   | 4/0-6/0  |
| mit Teilung 0,5 mm für Nahtmaterial   | bis 3/0  |
| mit Teilung 0,6 mm für große Nadeln oder Draht  |          |

|   |           |
|---|-----------|
| We recommend tungsten carbide jaws with smooth surface and Micro Grip for suture material | 9/0-11/0  |
| with serration 0,2 mm – 0,3 mm and Micro Grip for suture material                         | 6/0-10/0  |
| with serration 0,4 mm for suture material   | 4/0-6/0   |
| with serration 0,5 mm for suture material   | up to 3/0 |
| with serration 0,6 mm for big needles or wire   |           |

|   |           |
|---|-----------|
| Les recomendamos placas de tungsteno carburo con superficie lisa y Micro-Grip para material de sutura | 9/10-11/0 |
| con dentado 0,2 mm – 0,3 mm y Micro-Grip para material de sutura                                      | 6/0-10/0  |
| con dentado 0,4 mm para material de sutura  | 4/0-6/0   |
| con dentado 0,5 mm para material de sutura  | hasta 3/0 |
| con dentado 0,6 mm para agujas grandes o alambre  |           |

|  |             |
|--|-------------|
| Nous recommandons des mors en carbure de tungstène avec surface lisse et Micro-Grip pour des sutures | 9/0-11/0    |
| avec denture 0,2 mm – 0,3 mm et Micro-Grip pour des sutures  | 6/0-10/0    |
| avec denture 0,4 mm pour des sutures   | 4/0-6/0     |
| avec denture 0,5 mm pour des sutures   | jusqu'à 3/0 |
| avec denture 0,6 mm pour des grandes aiguilles ou fils   |             |

|  |            |
|--|------------|
| Consigliamo il morso con placche di carburo di tungsteno liscie e Micro-Grip per materiale da sutura | 9/0-11/0   |
| con zigrinatura 0,2 mm – 0,3 mm Micro Grip per materiale da sutura                                   | 6/0-10/0   |
| con zigrinatura 0,4 mm per materiale da sutura   | 4/0-6/0    |
| con zigrinatura 0,5 mm per materiale da sutura   | fino a 3/0 |
| con zigrinature 0,6 mm per aghi grande oppure fili   |            |

### MIKRO-GRIP PINZETTEN UND NADELHALTER

Unter dem Titel „Mikro-Grip“ bieten wir ein selektives Programm von Produkten mit Hartstoffbeschichtung an. Bei diesem Verfahren wird funkenerosiv Hartmetall (Wolframkarbid) auf und in die Werkstückoberfläche übertragen. Dabei liegen die eindeutigen Vorteile darin, daß sich diese Schicht durch Anschmelzen mit dem Grundwerkstoff verbindet. Ein Ausbrechen dieser Kristalle, wie dies häufig bei der Diamant-Beschichtung zu beobachten ist, ist damit ausgeschlossen, ein bedeutender Sicherheitsvorteil.

- Erhöhung der Oberflächenhärte (HV 1000 – 1400), und damit langlebige Griffigkeit des Instruments.
- Mikrofeine Beschichtung verhindert eine Beschädigung der Nadel bzw. des Nahtmaterials und damit eine klinisch riskante Traumatisierung.
- Die feine kristallisierte Maulfläche des Instruments verhindert das Verdrehen der Nadel oder des Nahtmaterials.
- Alle „Mikro-Grip“ Instrumente geben dem Chirurgen eine spürbar verbesserte Kontrolle über das Produkt, und damit über seine Arbeit.

## **MICRO-GRIP DISSECTING FORCEPS AND NEEDLE HOLDERS**

With „Micro-Grip Instruments“ we are offering a selective range of products with tungsten carbide coating.

In the manufacturing procedure of these instruments, tungsten carbide is put on to the instrument's jaw by emitting sparks. The definitive advantage of this procedure is that the tungsten carbide coat combines with the basic material by melting together. The breaking out of the crystals, as it can occur with diamant coatings, therefore is hardly possible.

The Micro-Grip instruments have important advantages:

- a higher grade of surface hardness (HV 1000 – 1400) and therefore a long-lasting „grip“ of the instruments.
- the micro-fine coating avoids the damage of the needle resp. the suture material and therefore a clinically dangerous traumatization.
- the fine crystallized jaw of the instruments avoids the twisting of the needle or the suture material.
- all Micro-Grip instruments allow the surgeon a perceptibly increased control over the product and, in consequence, over his work.

## **MICRO-GRIP PINZAS DE DISECCION Y PORTA-AGUJAS**

Bajo la denominación „Micro-Grip“ ofrecemos un programa selectivo de productos con recubrimiento de carburo tungsteno.

En este procedimiento el carburo tungsteno se transmite por proyección de chispas a la superficie de la materia prima. La clara ventaja de este procedimiento es que el recubrimiento se une por fundación con la materia prima. Contrariamente al recubrimiento con diamantes, estos cristales no se rompen lo que significa una ventaja de seguridad considerable.

Estos instrumentos ofrecen las siguientes ventajas:

- Aumento del temple de la superficie (HV 1000 – 1400) y por lo tanto adherencia de larga duración del instrumento.
- Un recubrimiento micro-fino evita un deterioro de la aguja y del material de sutura y, por consecuencia, evita lesiones arriesgadas.
- La superficie cristalina de la boca evita la torsión de la aguja y del material de sutura.
- El instrumental „Micro-Grip“ garantiza al cirujano un control sobre el producto sensiblemente mejorado y por lo tanto un control sobre su trabajo.

## **PINCES ET PORTE-AIGUILLES MICRO-GRIP**

Sous le titre „Micro-Grip“, nous proposons un programme sélectif d'articles avec un revêtement de carbure de tungstène.

Lors du procédé de fabrication de ces instruments, le carbure de tungstène est appliqué sur la surface du mors de l'instrument par émission d'étincelles. L'énorme avantage de ce procédé est que cela permet au revêtement de carbure de tungstène de se lier parfaitement au support. Les cristaux ainsi formé, contrairement au revêtement diamant, peuvent très difficilement se rompre.

Les instruments Micro-Grip ont les avantages suivants:

- une haute valeur de dureté superficielle (HV 1000 – 1400) assurant ainsi une excellente longévité du mors de l'instrument.
- le revêtement extrêmement fin évite tout endommagement de l'aiguille et du matériel de suture, réduisant par conséquent le risque de lésions.
- la surface cristalline de l'instrument évite la torsion de l'aiguille et du matériel de suture.
- l'instrumentation Micro-Grip garantit au chirurgien un contrôle de l'instrument sensiblement amélioré, donc un meilleur travail.

## **PINZE E PORTAGHI MICRO-GRIP**

Presentiamo sotto il titolo „Micro-Grip“ un programma selettivo di strumenti con un rivestimento di carburo di tungsteno.

Durante il processo di fabbricazione di questi strumenti, il carburo di tungsteno viene depositato sulla superficie dello morso mediante un'emissione di scintille. Il grande vantaggio di questo processo risiede nel fatto che il rivestimento di carburo di tungsteno si può legare perfettamente con il supporto. I cristalli così formati, al contrario del rivestimento diamante, possono difficilmente rompersi.

Gli strumenti Micro-Grip hanno i seguenti vantaggi:

- Un'alta durezza superficiale (HV 1000 – 1400) che assicura una maggiore longevità del morso dello strumento.
- Il rivestimento molto fine impedisce il danneggiamento dell'ago e del materiale da sutura, quindi riduce i rischi di lesioni.
- La superficie cristallina del morso impedisce la rotazione dell'ago e del materiale da sutura.
- Lo strumentario Micro-Grip garantisce al chirurgo un perfetto controllo dello strumento migliorando così il suo lavoro.

Übersichtstafel  
General Content  
Cuadro sinóptico  
Table des matières  
Indice delle sezioni



Scheren  
Scissors  
Tijeras  
Ciseaux  
Forbici

2 – 22



Klemmen, Gefäßclips  
Forceps, Vascular Clips  
Pinzas hemostáticas, Clips vasculares  
Pincas hémostatiques, Clips vasculaires  
Pinze emostatiche, Serrafini

24 – 39



Pinzetten  
Dissecting Forceps  
Pinzas de disección  
Pincas à disséquer  
Pinze anatomiche

42 – 46

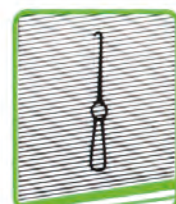

Wundhaken, Wundsperrer  
Retractors, Self Retaining Retractors  
Separadores y ganchos  
Ecarteurs et Crochets  
Divaricatori ed uncini

48 – 56

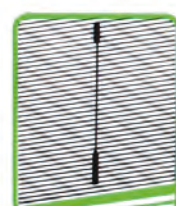

Gefäßinstrumente  
Vessel Instruments  
Instrumental vascular  
Instruments pour vaisseaux  
Strumenti vascolari

58 – 66



Knocheninstrumente  
Bone Instruments  
Instrumental óseo  
Instruments à os  
Strumenti ossea

68 – 74



Drahtinstrumente  
Wire Instruments  
Instrumental para alambre  
Instruments à fils  
Strumenti per fili

76 – 78





Nadelhalter  
Needle Holders  
Porta-agujas  
Porte-aiguilles  
Portaghi

80 – 90



Gewebe- und Organfaßzangen  
Tissue and Organ Grasping Forceps  
Pinzas para coger tejidos y órganos  
Pincas à tissue et à saisir les organes  
Pinze per afferrare tessuti ed organi

92, 93



Rippenscheren, Sternumscheren  
Rib Shears, Sternum Scissors  
Costótomos, Tijeras de esternón  
Costotomes, Ciseaux à sternum  
Costotomi, Forbici per sterno

96 – 98



Rippensperrer  
Rib Spreaders  
Separadores costales  
Ecarteurs costaux  
Divaricatori costali

100 – 108



Gefäßklemmen, Atrauma Klemmen  
Vessel Clamps, Atraumatic Clamps  
Clamps vasculares, Clamps atraumaticos  
Clamps vasculaires, Clamps atraumatiques  
Pinze vascolari atraumatiche

110 – 158



Etus für Bulldogklemmen  
Cases for Bulldog Clamps  
Estuches para clamps Bulldog  
Boîtes pour clamps bulldog  
Scatole per pinze Bulldog

160



Der Ihnen vorliegende Cardiovascular-Katalog ist auf ihren Namen registriert. Er darf nur zum Verkauf von RUDOLF-Instrumenten verwendet werden.

Nachdruck, auch auszugsweise, ist verboten.

Alle unsere Kataloge und Prospekte sowie Preislisten dürfen Dritten nicht zugänglich gemacht werden. Es gelten unsere allgemeinen Lieferungs- und Zahlungsbedingungen, die in unserer Preisliste enthalten sind.

Modelländerungen behalten wir uns vor.

Ausgabe 2010

---

The catalogue you have in hands is registered in your name. It may only be used for the sale and promotion of RUDOLF products. No part of this publication may be reproduced. None of our catalogues may be opened to third parties. All deliveries are subject to the general conditions of payment and supply which may be found in our price list.

Patterns are subject to change.

Edition 2010

---

El presente catálogo cardiovascular está registrado a su nombre. Solo se puede utilizar para la venta de instrumental RUDOLF. Se prohíbe la reproducción total o parcial del presente catálogo. Todos nuestros catálogos y listas de precios son entregados a nivel personal por lo que no deben ser puestos al alcance de terceros. Las condiciones generales de pago y entrega, rigen las que se encuentran expresadas en nuestra lista de precios.

Nos reservamos del derecho de cambiar o modificar los modelos de nuestro catálogo.

Edición de 2010

---

Le présent catalogue est enregistré à votre nom. Il doit être utilisé exclusivement pour la vente d'instruments RUDOLF.

Toutes copies ou extraits sont interdits. Tous nos catalogues ou prospectus ne peuvent être donnés à une tierce. Nos conditions de livraison et de paiement sont celles stipulés sur notre liste de prix.

Nous nous réservons tout droit de modification sur les modèles présentés dans le catalogue.

Édition 2010

---

Il presente catalogo è registrato a Suo nome. Deve essere utilizzato solo per la vendita degli strumenti RUDOLF.

Riproduzioni, anche solo per dimostrazione, sono vietate. I nostri cataloghi e depliant, come anche i listini prezzi, non possono essere resi accessibili a tutti. Valgono le nostre condizioni di fornitura e pagamento che sono contenute nel nostro listino prezzi.

Ci riserviamo il diritto di modificare i prodotti di questo catalogo.

Edizione 2010

Scheren  
Scissors  
Tijeras  
Ciseaux  
Forbici

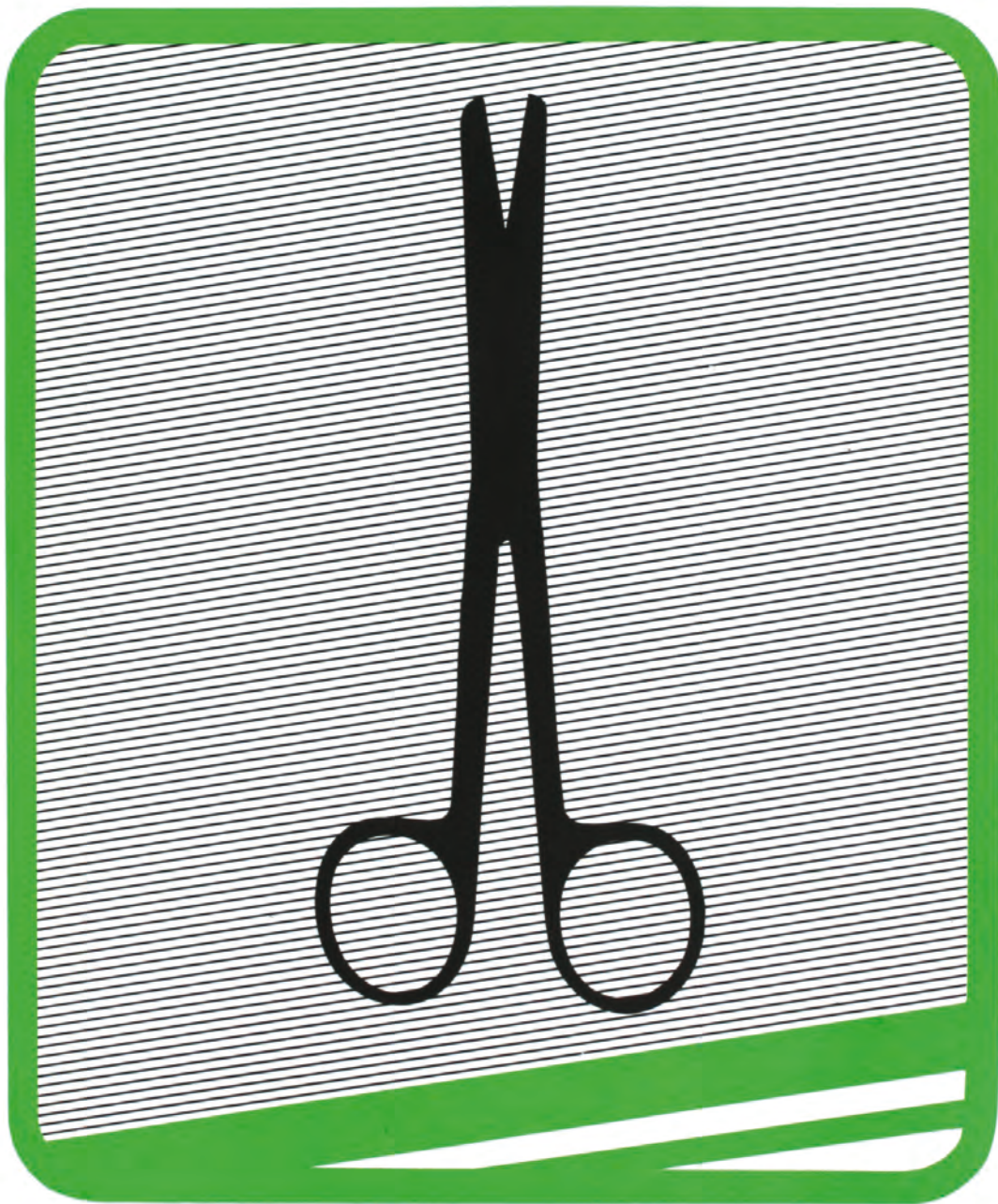



Chirurgische Scheren  
 Operating Scissors  
 Tijeras para cirugía  
 Ciseaux chirurgicaux  
 Forbici per chirurgia



gerade  
 straight  
 rectas  
 droits  
 rette

Standard  
 Fig. 1



gerade  
 straight  
 rectas  
 droits  
 rette

Standard  
 Fig. 2



gerade  
 straight  
 rectas  
 droits  
 rette

Standard  
 Fig. 3

|   |            |            |            |
|---|------------|------------|------------|
| 14,5 cm/5 <sup>3</sup> / <sub>4</sub> " | RU 1001-14 | RU 1002-14 | RU 1003-14 |
| 15,5 cm/6"                              | RU 1001-15 | RU 1002-15 | RU 1003-15 |
| 16,5 cm/6 <sup>1</sup> / <sub>2</sub> " | RU 1001-16 | RU 1002-16 | RU 1003-16 |

**Rudolf**  
 TC



gerade  
 straight  
 rectas  
 droits  
 rette

Standard  
 14,5 cm/5<sup>3</sup>/<sub>4</sub>"



Fig. 1  
 RU 1004-14



Fig. 2  
 RU 1006-14



Fig. 3  
 RU 1008-14



gebogen  
 curved  
 curvas  
 courbes  
 curve

Standard  
 Fig. 1



gebogen  
 curved  
 curvas  
 courbes  
 curve

Standard  
 Fig. 2



gebogen  
 curved  
 curvas  
 courbes  
 curve

Standard  
 Fig. 3

|   |            |            |            |
|---|------------|------------|------------|
| 14,5 cm/5 <sup>3</sup> / <sub>4</sub> " | RU 1011-14 | RU 1012-14 | RU 1013-14 |
| 15,5 cm/6"                              | RU 1011-15 | RU 1012-15 | RU 1013-15 |
| 16,5 cm/6 <sup>1</sup> / <sub>2</sub> " | RU 1011-16 | RU 1012-16 | RU 1013-16 |

**Rudolf**  
 TC



gebogen  
 curved  
 curvas  
 courbes  
 curve

Standard  
 14,5 cm/5<sup>3</sup>/<sub>4</sub>"



Fig. 1  
 RU 1014-14



Fig. 2  
 RU 1016-14



Fig. 3  
 RU 1018-14



**Ligaturscheren**  
**Ligature Scissors**  
**Tijeras para ligaduras**  
**Ciseaux à ligatures**  
**Forbici per legature**



Ligaturscheren speziell zum Schneiden von Nahtmaterial

- Hartmetalleinlagen gewährleisten dauerhafte Schnittschärfe
- eine speziell angebrachte feinste Zahnung verhindert das Abgleiten des Nahtmaterials

Ligature scissors especially for the cutting of suture material

- TC inserts ensure permanent sharpness
- an especially made most finest serration prevents the slipping of the suture material

Tijeras para ligaduras especialmente para cortar material de sutura

- placas de TC garantizan un corte permanente
- un dentado muy fino evita un deslizamiento del material de sutura

Ciseaux à ligatures pour couper le matériel à suture

- les plaques en TC garantissent une coupure permanente
- la denture plus fine évite la glissade du matériel à suture

Forbici per legature speciali per tagliare materiale da sutura

- con inserti TC affinché l'affilatura si mantenga nel tempo
- con una dentellatura fine per impedire un eventuale scivolamento del materiale da sutura



Mayo

Metzenbaum

|             |               |               |
|-------------|---------------|---------------|
| 14,5 cm/5¾" | RU 1253-14 RS | RU 1314-14 RS |
| 17 cm/6¾"   | RU 1253-17 RS |               |
| 18 cm/7"    |               | RU 1334-18 RS |
| 23 cm/9"    | RU 1253-23 RS | RU 1334-23 RS |
| 26 cm/10¼"  |               | RU 1334-26 RS |

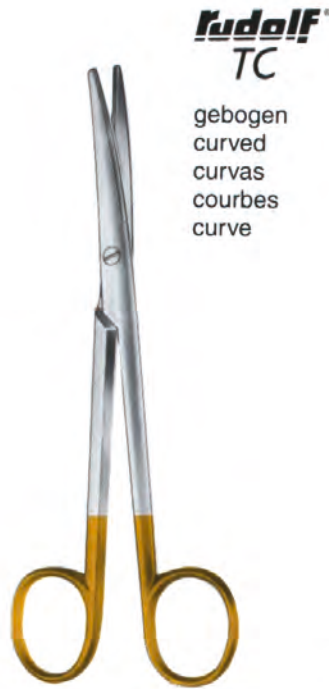

**Rudolf**  
TC

gebogen  
curved  
curvas  
courbes  
curve

RU 1103-16

Lexer  
16 cm/6<sup>1</sup>/<sub>4</sub>"



**Rudolf**  
SUPERCUT TC

gezahnt  
saw edge  
dentadas  
dentelés  
dentellate

RU 1103-16 MC



gerade  
straight  
rectas  
droits  
rette

Mayo



gebogen  
curved  
curvas  
courbes  
curve

Mayo



**Rudolf**  
TC

gerade  
straight  
rectas  
droits  
rette

Mayo



gebogen  
curved  
curvas  
courbes  
curve

|   |            |            |            |            |
|---|------------|------------|------------|------------|
| 14,5 cm/5 <sup>3</sup> / <sub>4</sub> " | RU 1250-14 | RU 1251-14 | RU 1252-14 | RU 1253-14 |
| 17 cm/6 <sup>3</sup> / <sub>4</sub> "   | RU 1250-17 | RU 1251-17 | RU 1252-17 | RU 1253-17 |
| 23 cm/9"                                | RU 1250-23 | RU 1251-23 | RU 1252-23 | RU 1253-23 |
| 28 cm/11"                               | RU 1250-28 | RU 1251-28 |            |            |



**Präparierscheren**  
**Dissecting Scissors**  
**Tijeras para preparaciones**  
**Ciseaux à dissection**  
**Forbici per dissezione**



gebogen  
curved  
curvas  
courbes  
curve

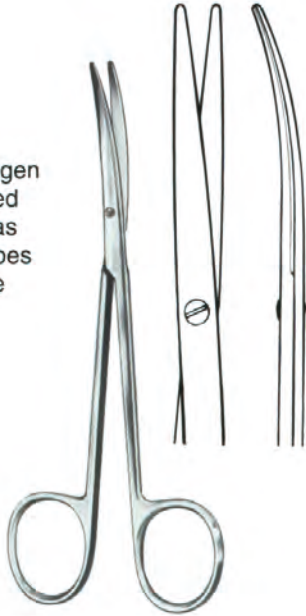

**Metzenbaum-Fino**

14,5 cm/5<sup>3</sup>/<sub>4</sub>"  
RU 1291-14

**Rudolf**  
TC

gerade  
straight  
rectas  
droits  
rette



**Metzenbaum**

14,5 cm/5<sup>3</sup>/<sub>4</sub>"  
RU 1304-14

**Rudolf**  
TC

gebogen  
curved  
curvas  
courbes  
curve



**Metzenbaum**

14,5 cm/5<sup>3</sup>/<sub>4</sub>"  
RU 1314-14



**Metzenbaum-Fino**

14,5 cm/5<sup>3</sup>/<sub>4</sub>"  
RU 1316-14



**Präparierscheren**  
**Dissecting Scissors**  
**Tijeras para preparaciones**  
**Ciseaux à dissection**  
**Forbici per dissezione**



**Rudolf<sup>®</sup>**  
**TC**

gerade  
straight  
rectas  
droits  
rette



**Metzenbaum**

**Metzenbaum-Fino**

|           |                   |                   |
|-----------|-------------------|-------------------|
| 18 cm/7"  | <b>RU 1324-18</b> | <b>RU 1326-18</b> |
| 20 cm/8"  | <b>RU 1324-20</b> | <b>RU 1326-20</b> |
| 23 cm/9"  | <b>RU 1324-23</b> | <b>RU 1326-23</b> |
| 25 cm/10" | <b>RU 1324-25</b> | <b>RU 1326-25</b> |
| 28 cm/11" | <b>RU 1324-28</b> | <b>RU 1326-28</b> |
| 30 cm/12" | <b>RU 1324-30</b> |                   |

**Rudolf<sup>®</sup>**  
**TC**

gebogen  
curved  
curvas  
courbes  
curve

gebogen  
curved  
curvas  
courbes  
curve



**Metzenbaum-Fino**

**Metzenbaum**

**Metzenbaum**

**Metzenbaum-Fino**

|           |                   |                   |                   |                   |
|-----------|-------------------|-------------------|-------------------|-------------------|
| 18 cm/7"  | <b>RU 1330-18</b> | <b>RU 1331-18</b> | <b>RU 1334-18</b> | <b>RU 1336-18</b> |
| 20 cm/8"  | <b>RU 1330-20</b> | <b>RU 1331-20</b> | <b>RU 1334-20</b> | <b>RU 1336-20</b> |
| 23 cm/9"  | <b>RU 1330-23</b> | <b>RU 1331-23</b> | <b>RU 1334-23</b> | <b>RU 1336-23</b> |
| 25 cm/10" | <b>RU 1330-25</b> | <b>RU 1331-25</b> | <b>RU 1334-25</b> | <b>RU 1336-25</b> |
| 28 cm/11" | <b>RU 1330-28</b> | <b>RU 1331-28</b> | <b>RU 1334-28</b> | <b>RU 1336-28</b> |
| 30 cm/12" |                   | <b>RU 1331-30</b> | <b>RU 1334-30</b> |                   |



**Präparierscheren, Chirurgische Scheren  
 Dissecting Scissors, Operating Scissors  
 Tijeras para preparaciones, Tijeras para cirugía  
 Ciseaux à dissection, Ciseaux chirurgicaux  
 Forbici per dissezione, Forbici per chirurgia**



gezahnt  
 saw edge  
 dentadas  
 dentelés  
 dentellate

gebogen  
 curved  
 curvas  
 courbes  
 curve

**Metzenbaum**

**Metzenbaum**

|             |  |                   |
|-------------|--|-------------------|
| 14,5 cm/5¾" | <b>RU 1314-14 MC</b>                     | <b>RU 1339-15</b> |
| 18 cm/7"    | <b>RU 1334-18 MC</b>                     | <b>RU 1339-18</b> |
| 20 cm/8"    | <b>RU 1334-20 MC</b>                     | <b>RU 1339-20</b> |
| 23 cm/9"    | <b>RU 1334-23 MC</b>                     | <b>RU 1339-23</b> |
| 26 cm/10¼"  |  | <b>RU 1339-26</b> |
| 18 cm/7"    | <b>Metzenbaum-Fino<br/>RU 1336-18 MC</b> |                   |



**Kelly  
 RU 1440-18**



**Kelly  
 18 cm/7"  
 RU 1441-18**



**Rudolf**  
 SUPERCUT

gezahnt  
 saw edge  
 dentadas  
 dentelés  
 dentellate

gerade – straight  
 rectas – droits  
 rette

gebogen – curved  
 curvas – courbes  
 curve

**Reynolds**

**RU 1580-15 MC** 15 cm/6" **RU 1582-15 MC**



gerade – straight  
 rectas – droits  
 rette



gebogen – curved  
 curvas – courbes  
 curve

**Reynolds**

**RU 1580-15** 15 cm/6" **RU 1581-15**  
**RU 1580-18** 18 cm/7" **RU 1581-18**



gebogen – curved  
 curvas – courbes  
 curve

**Jameson-Werber**

13 cm/5"  
**RU 1584-13**



gerade – straight  
 rectas – droits  
 rette



gebogen – curved  
 curvas – courbes  
 curve

**Joseph**

**RU 1670-14** 14 cm/5½" **RU 1671-14**



**Gefäßscheren**  
**Vascular Scissors**  
**Tijeras vasculares**  
**Ciseaux vasculaires**  
**Forbici vascolari**



Koronar-Schere  
Coronary scissors  
Tijeras coronarias  
Ciseaux coronaires  
Forbici coronari



11,5 cm/4 $\frac{1}{2}$ "  
RU 1705-11



**Potts-Smith**  
19,5 cm/7 $\frac{3}{4}$ "  
RU 1710-19



**De Bakey**  
15,5 cm/6"  
RU 1713-15



**De Bakey**  
15,5 cm/6"  
RU 1714-15



**Favaloro**  
15 cm/6"  
RU 1715-15

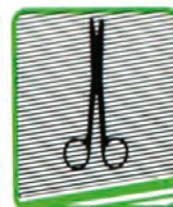

**rudolf**  
SUPERCUT

Endarterektomie-Schere  
Endarterectomy scissors  
Tijeras para endarterectomia  
Ciseaux pour endartérectomie  
Forbici per endarterectomia



gezahnt  
saw edge  
dentadas  
dentelés  
dentellate

17 cm/6<sup>3</sup>/<sub>4</sub>"  
RU 1718-17 MC

**rudolf**  
SUPERCUT

gezahnt  
saw edge  
dentadas  
dentelés  
dentellate



25°  
RU 1720-19 MC

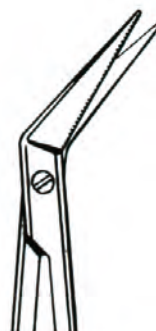

45°  
RU 1721-19 MC

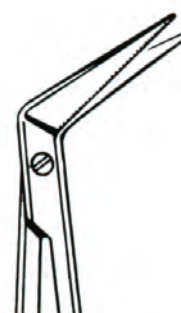

60°  
RU 1722-19 MC

**Potts-Smith**  
19 cm/7<sup>1</sup>/<sub>2</sub>"



Gefäßscheren  
Vascular Scissors  
Tijeras vasculares  
Ciseaux vasculaires  
Forbici vascolari



**Rudolf**  
TC

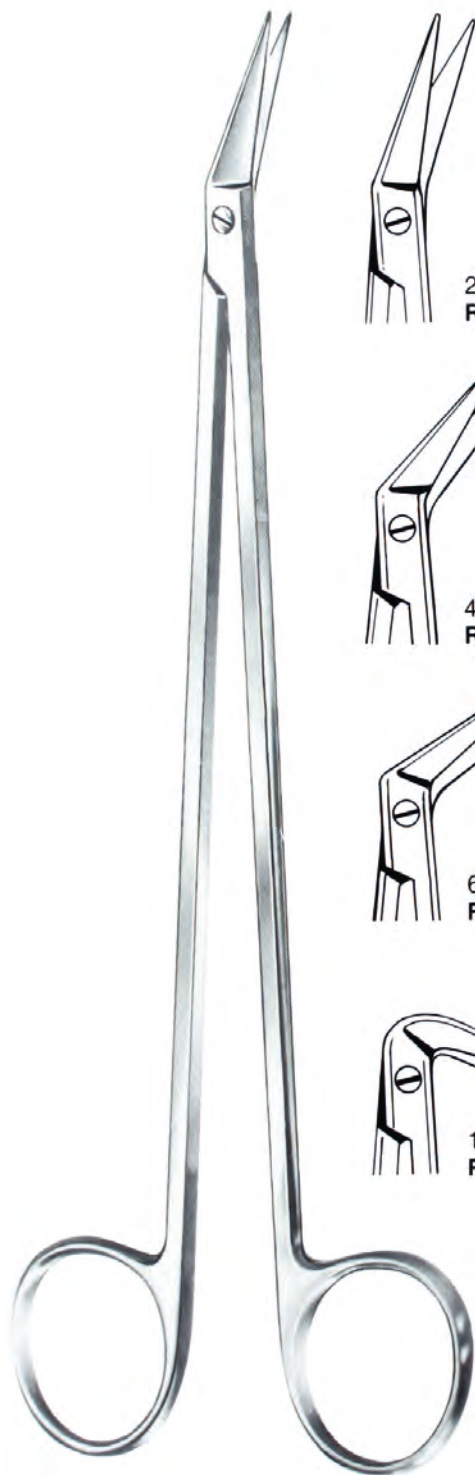

**Potts-Smith**  
19 cm/7 1/2"

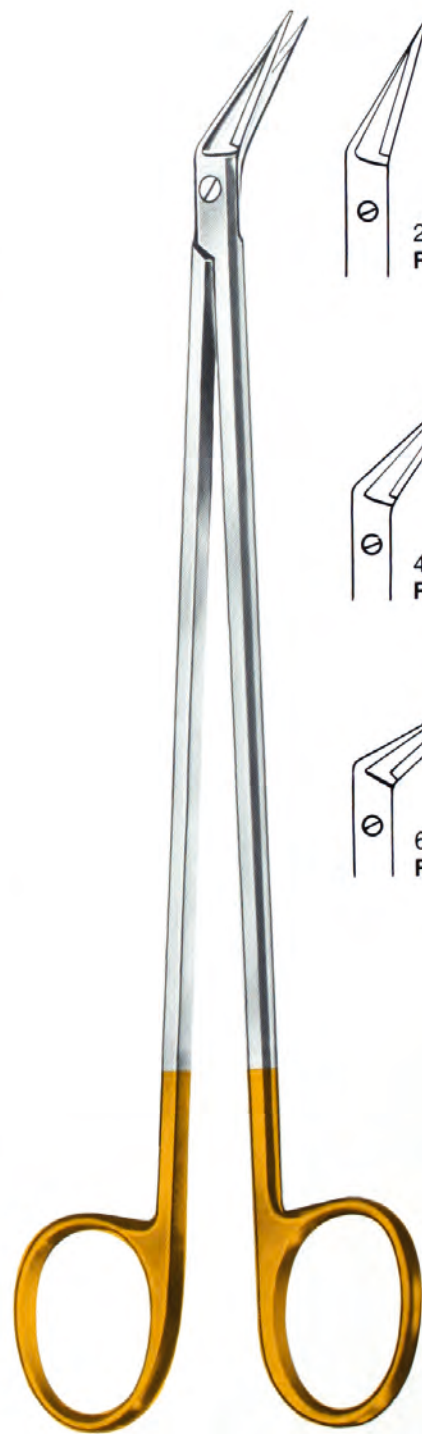
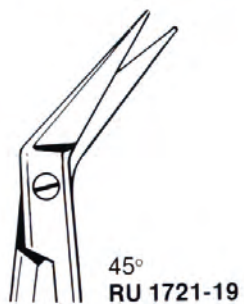
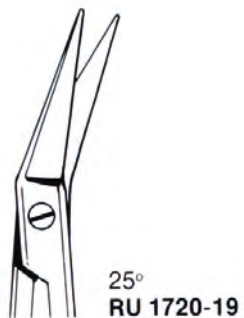

**Potts-Smith**  
19 cm/7 1/2"

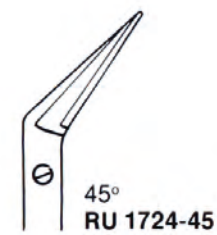
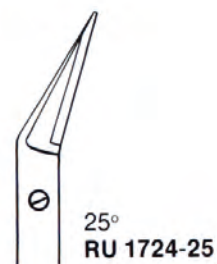

Gefäßscheren  
 Vascular Scissors  
 Tijeras vasculares  
 Ciseaux vasculaires  
 Forbici vascolari



**Potts-Smith**  
 19 cm/7½"  
 RU 1735-19



**Jorgensen**  
 22 cm/8¾"  
 RU 1739-22



**Satinsky**  
 24,5 cm/10"  
 RU 1740-24



**Rudolf<sup>®</sup>**  
**TC**  
 RU 1744-23

**Klingenberg-Loth**  
 23 cm/9"  
 RU 1745-23



**Tönnis-Adson**  
 17,5 cm/7"  
 RU 1829-17



**Gefäßscheren**  
**Vascular Scissors**  
**Tijeras vasculares**  
**Ciseaux vasculaires**  
**Forbici vascolari**



**DeBakey**



25°



45°

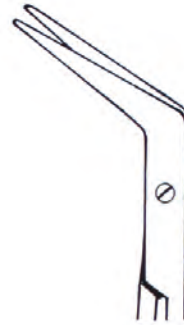

60°

| cm    | in     |            |            |            |
|-------|--------|------------|------------|------------|
| 16 cm | 6 1/4" | RU 1750-16 | RU 1752-16 | RU 1754-16 |
| 23 cm | 9"     | RU 1750-23 | RU 1752-23 | RU 1754-23 |
| 28 cm | 11"    | RU 1750-28 |            | RU 1754-28 |



|          |            |            |            |
|----------|------------|------------|------------|
| 18 cm/7" | RU 1755-25 | RU 1755-45 | RU 1755-60 |
| 23 cm/9" | RU 1756-25 | RU 1756-45 | RU 1756-60 |



**Baby-Hegemann**

13,5 cm/5 1/4"



25°



45°



60°



90°



125°

| cm      | in     |            |            |            |            |            |
|---------|--------|------------|------------|------------|------------|------------|
| 13,5 cm | 5 1/4" | RU 1760-13 | RU 1761-13 | RU 1762-13 | RU 1763-13 |            |
| 16 cm   | 6 1/4" | RU 1760-16 | RU 1761-16 | RU 1762-16 | RU 1763-16 | RU 1764-16 |
| 19 cm   | 7 1/2" | RU 1760-19 | RU 1761-19 | RU 1762-19 | RU 1763-19 | RU 1764-19 |

**Hegemann (Diethrich)**

16 cm/6 1/4"  
 19 cm/7 1/2"



**Hegemann (Diethrich)**

19 cm/7 1/2"  
 RU 1765-19





18 cm/7"

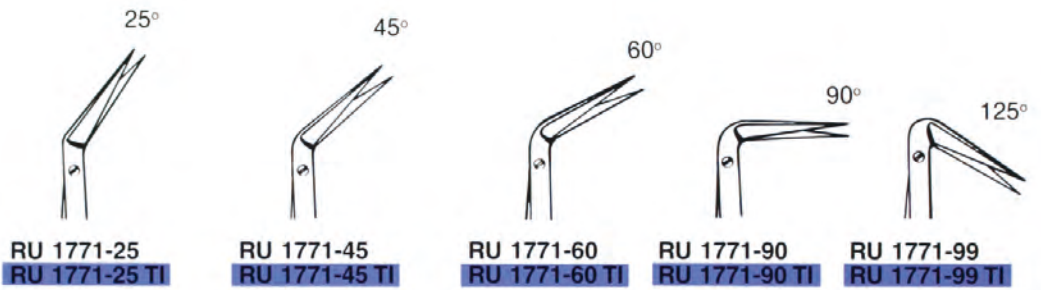
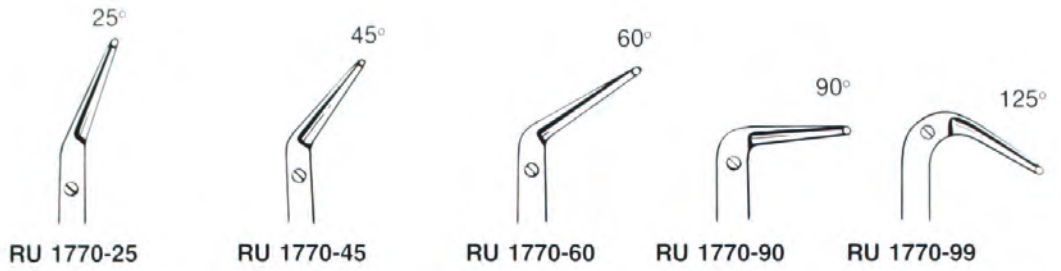

18 cm/7"

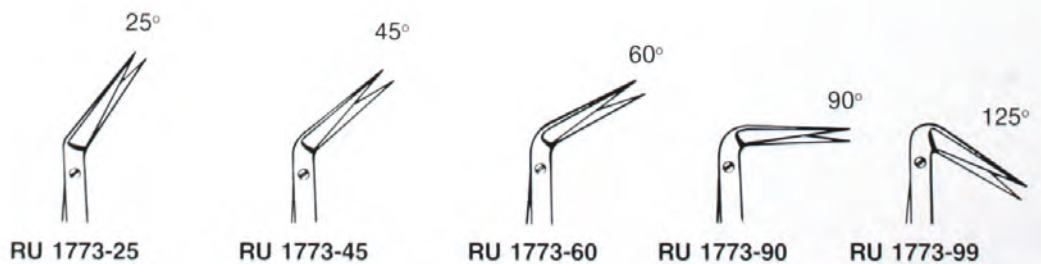
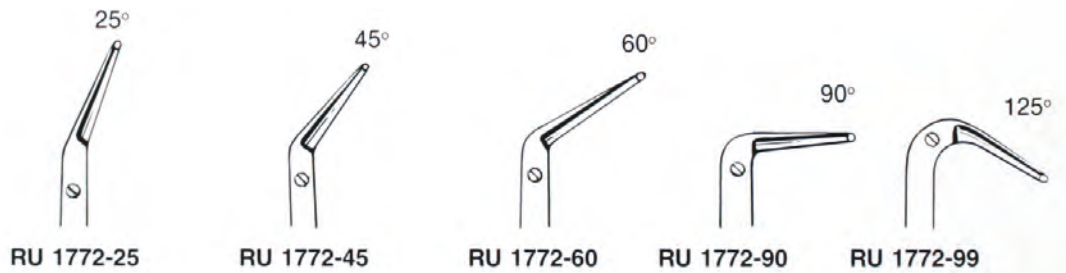

**TI = TITAN**



Gefäßscheren  
 Vascular Scissors  
 Tijeras vasculares  
 Ciseaux vasculaires  
 Forbici vascolari



Jacobsen  
 18 cm/7"

RU 2350-18  
 RU 2350-18 TI



RU 2360-19

RU 2351-18  
 RU 2351-18 TI



RU 2361-19

RU 2352-18



RU 2362-19



RU 2364-19



RU 2365-19



19 cm/7 1/2"

TI = TITAN



gerade  
 straight  
 rectas  
 droits  
 rette



gebogen  
 curved  
 curvas  
 courbes  
 curve



kniegebogen  
 angulated  
 acodadas  
 coudés  
 angolate



gerade  
 straight  
 rectas  
 droits  
 rette



gebogen  
 curved  
 curvas  
 courbes  
 curve

16 cm/6¼" RU 2370-16  
 18,5 cm/7¼" RU 2370-18

RU 2371-16  
 RU 2371-18

RU 2375-18

RU 2372-16

RU 2373-16



**Mikroscheren  
Micro Scissors  
Micro-tijeras  
Micro-ciseaux  
Micro-forbici**

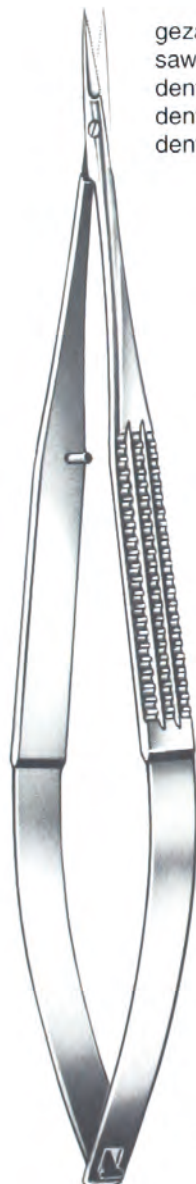

gezahnt  
saw edge  
dentadas  
dentelés  
dentellate

**Millesi**  
gerade  
straight  
rectas  
droits  
rette

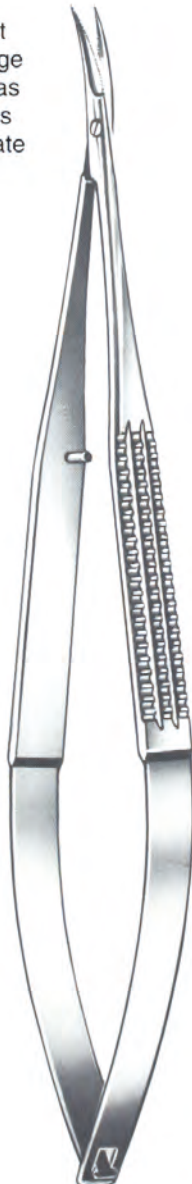

**Millesi**  
gebogen  
curved  
curvas  
courbes  
curve

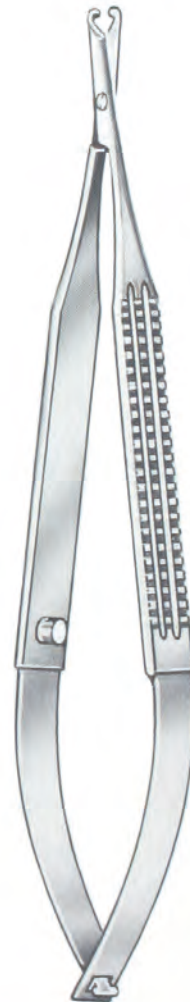

Venenschere  
Vein scissors  
Tijeras para venotomia  
Ciseaux à veines  
Forbici per le vene

gerade  
straight  
rectas  
droits  
rette

13 cm/5"

16 cm/6¼"

**RU 2376-16**

**RU 2377-16**

**RU 2370-01/13**



gerade  
 straight  
 rectas  
 droits  
 rette



gebogen  
 curved  
 curvas  
 courbes  
 curve



kniegebogen  
 angulated  
 acodadas  
 coudés  
 angolate



gerade  
 straight  
 rectas  
 droits  
 rette



gebogen  
 curved  
 curvas  
 courbes  
 curve

14,5 cm/5¾"

RU 2380-14

RU 2388-14

16 cm/6¼"

RU 2380-16

RU 2381-16

RU 2382-16

RU 2383-16

RU 2382-18

RU 2383-18

RU 2385-18

18,5 cm/7¼"

**RU 2382-18 TI**

**RU 2383-18 TI**

RU 2382-23

23 cm/9"

**RU 2382-23 TI**



Mikroscheren  
 Micro Scissors  
 Micro-tijeras  
 Micro-ciseaux  
 Micro-forbici



Präparierschere  
 Dissecting scissors  
 Tijeras para preparaciones  
 Ciseaux à dissection  
 Forbici per preparazione

gezahnt  
 saw edge  
 dentadas  
 dentelés  
 dentellate



gerade  
 straight  
 rectas  
 droits  
 rette



gebogen  
 curved  
 curvas  
 courbes  
 curve



gebogen  
 curved  
 curvas  
 courbes  
 curve

**RU 2389-14**

14,5 cm/5¾"

**RU 2386-16**

**RU 2386-16 TI**

**RU 2387-16**

**RU 2387-16 TI**

16 cm/6¼"

18 cm/7"

**TI = TITAN**



**Potts-de Martel**

21 cm/8<sup>1</sup>/<sub>4</sub>"  
RU 2490-21



**Mills**

21 cm/8<sup>1</sup>/<sub>4</sub>"  
RU 2491-21



**RU 2496-22**



**Strully**

22 cm/8<sup>3</sup>/<sub>4</sub>"

**RU 2497-22**





**Klemmen, Gefäßclips**  
**Forceps, Vascular Clips**  
**Pinzas hemostáticas, Clips vasculares**  
**Pinces hémostatiques, Clips vasculaires**  
**Pinze emostatiche, Serrafini**



Atrauma-Klemmen siehe Seite 115 – 156  
Atraumatic clamps see page 115 – 156  
Clamps atraumaticos ver página 115 – 156  
Clamps atraumatiques voir page 115 – 156  
Pinze atraumatiche, vedere pagina 115 – 156

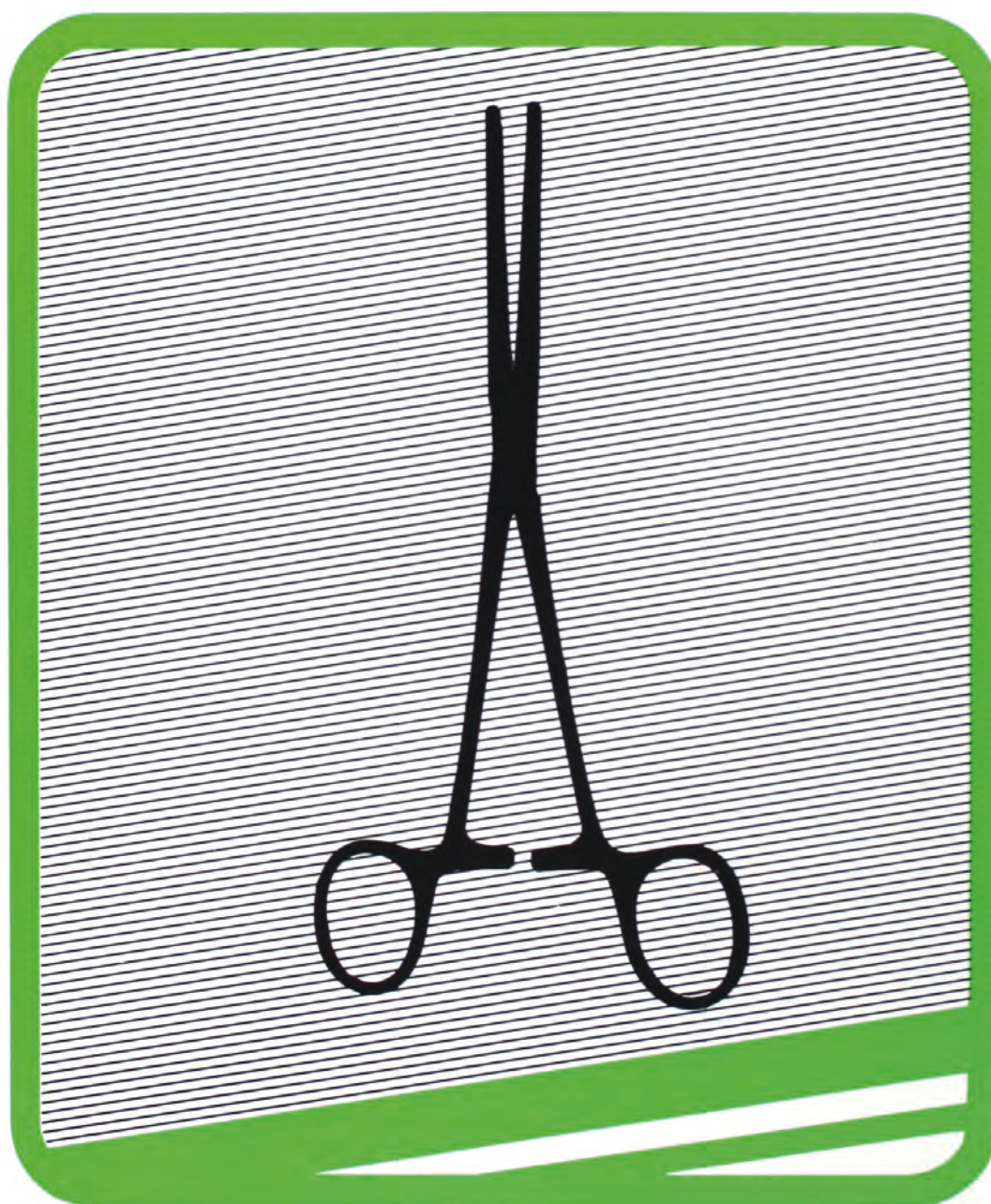



**Arterienklemmen  
Hemostatic Forceps  
Pinzas hemostáticas  
Pincas hémostatiques  
Pinze emostatiche**



gerade  
straight  
rectas  
droites  
rette



gebogen  
curved  
curvas  
courbes  
curve



**Rochester-Péan**



gerade  
straight  
rectas  
droites  
rette



gebogen  
curved  
curvas  
courbes  
curve

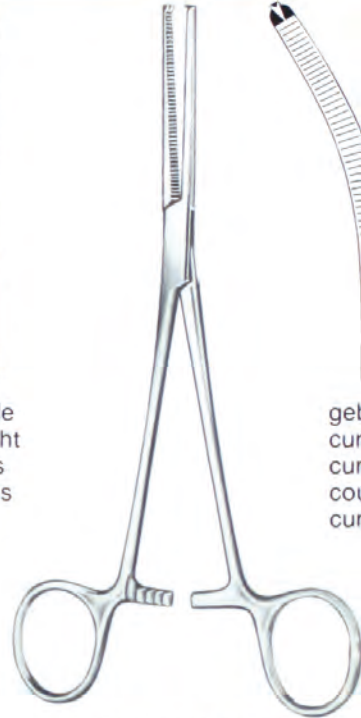

**Ochsner-Kocher**

|            |            | cm | in                             |            |            |
|------------|------------|----|--------------------------------|------------|------------|
| RU 3000-16 | RU 3001-16 | 16 | 6 <sup>1</sup> / <sub>4</sub>  | RU 3010-16 | RU 3011-16 |
| RU 3000-18 | RU 3001-18 | 18 | 7                              | RU 3010-18 | RU 3011-18 |
| RU 3000-20 | RU 3001-20 | 20 | 8                              | RU 3010-20 | RU 3011-20 |
| RU 3000-22 | RU 3001-22 | 22 | 8 <sup>3</sup> / <sub>4</sub>  | RU 3010-22 | RU 3011-22 |
| RU 3000-24 | RU 3001-24 | 24 | 9 <sup>1</sup> / <sub>2</sub>  | RU 3010-24 | RU 3011-24 |
| RU 3000-26 | RU 3001-26 | 26 | 10 <sup>1</sup> / <sub>4</sub> | RU 3010-26 | RU 3011-26 |
| RU 3000-30 | RU 3001-30 | 30 | 12                             | RU 3010-30 | RU 3011-30 |



gerade  
straight  
rectas  
droites  
rette



gebogen  
curved  
curvas  
courbes  
curve



**Péan**

fein  
fine  
finas  
fines  
fini



gerade  
straight  
rectas  
droites  
rette



gebogen  
curved  
curvas  
courbes  
curve



**Kocher**

|            |            | cm | in                            |            |            |
|------------|------------|----|-------------------------------|------------|------------|
| RU 3020-13 | RU 3021-13 | 13 | 5                             | RU 3030-13 | RU 3031-13 |
| RU 3020-14 | RU 3021-14 | 14 | 5 <sup>1</sup> / <sub>2</sub> | RU 3030-14 | RU 3031-14 |

Arterienklemmen  
 Hemostatic Forceps  
 Pinzas hemostáticas  
 Pinces hémostatiques  
 Pinze emostatiche



Leriche  
 15 cm/6"



RU 3080-15  
 RU 3080-15 TI



RU 3081-15  
 RU 3081-15 TI



RU 3082-15  
 RU 3082-15 TI



RU 3083-15  
 RU 3083-15 TI



Halsted-Mosquito  
 12,5 cm, 5"



RU 3100-12  
 RU 3100-12 TI



RU 3101-12  
 RU 3101-12 TI



RU 3110-12  
 RU 3110-12 TI



RU 3111-12  
 RU 3111-12 TI



Halsted-Mosquito  
 18 cm/7"  
 21 cm/8 1/4"



RU 3100-18  
 RU 3100-21



RU 3101-18  
 RU 3101-21



RU 3110-18  
 RU 3110-21



RU 3111-18  
 RU 3111-21

sehr fein  
 very fine  
 muy finas  
 très fines  
 molto fini



Jacobson-Halsted  
 13 cm/5"



RU 3114-13



RU 3115-13



Arterienklemmen, Präparier- und Ligaturklemmen  
 Hemostatic Forceps, Dissecting and Ligature Forceps  
 Pinzas hemostáticas, Pinzas para preparaciones y ligaduras  
 Pincès hémostatiques, Pincès à disséquer et à ligatures  
 Pinze emostatiche, Pinze per dissezione e legature



Micro-Mosquito

10 cm/4"  
 12 cm/4¾"

RU 3120-10  
 RU 3120-12

RU 3121-10  
 RU 3121-12  
**RU 3121-12TI**

10 cm/4"  
 12 cm/4¾"

RU 3122-10  
 RU 3122-12

RU 3123-10  
 RU 3123-12  
**RU 3123-12TI**



Hartmann  
 10 cm/4"

RU 3140-10  
**RU 3140-10TI**

RU 3141-10  
**RU 3141-10TI**



Adson  
 18,5 cm/7¼"

RU 3200-18

RU 3201-18



Baby-Adson

14 cm/5½"  
 RU 3205-14

18 cm/7"  
 RU 3205-18

Arterienklemmen, Präparier- und Ligaturklemmen  
 Hemostatic Forceps, Dissecting and Ligature Forceps  
 Pinzas hemostáticas, Pinzas para preparaciones y ligaduras  
 Pincès hémostatiques, Pincès à disséquer et à ligatures  
 Pinze emostatiche, Pinze per dissezione e legature



sehr fein  
 very fine  
 muy finas  
 très fines  
 molto fini



**Jacobson-Adson**  
 18 cm/7"

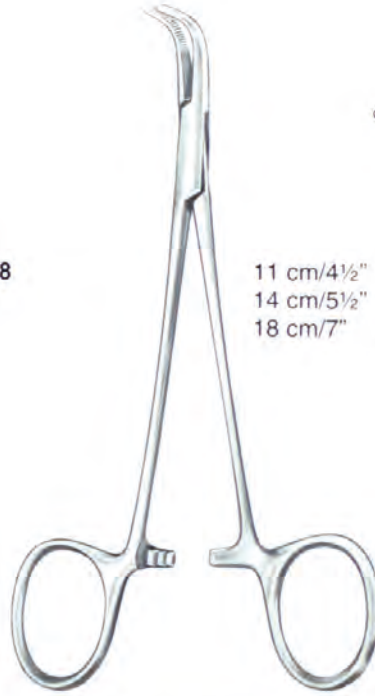
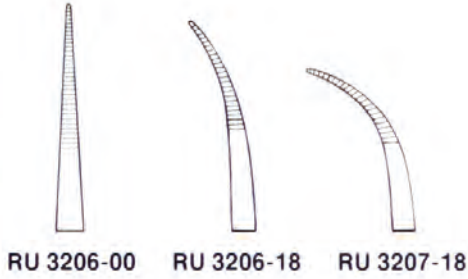

**Diethrich**

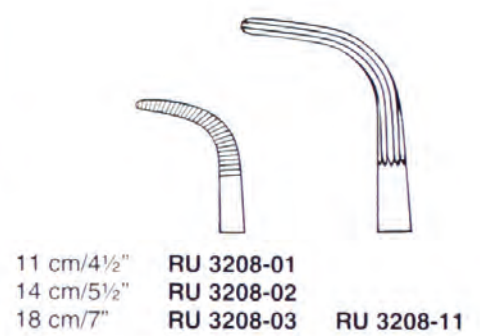

**Bengolea**

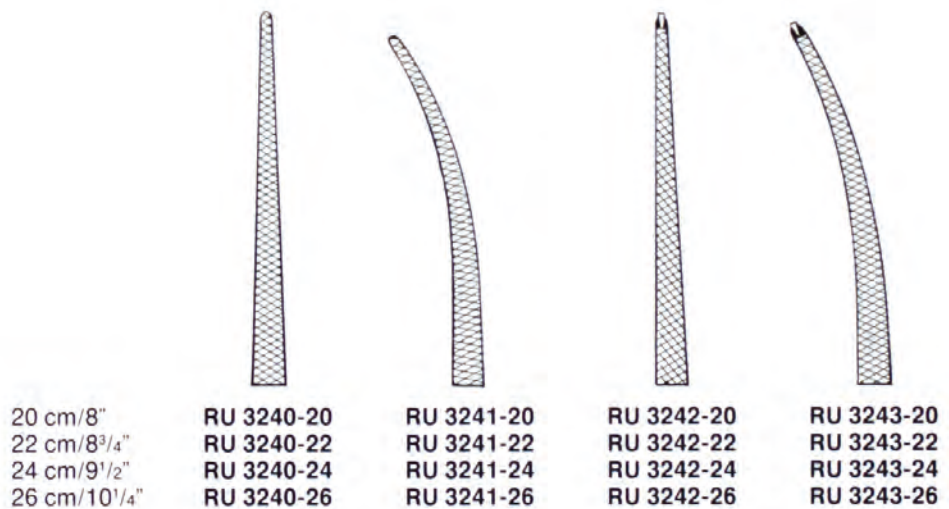

|  |                   |                   |                   |                   |
|--|-------------------|-------------------|-------------------|-------------------|
| 20 cm/8"                               | <b>RU 3240-20</b> | <b>RU 3241-20</b> | <b>RU 3242-20</b> | <b>RU 3243-20</b> |
| 22 cm/8 <sup>3</sup> / <sub>4</sub> "  | <b>RU 3240-22</b> | <b>RU 3241-22</b> | <b>RU 3242-22</b> | <b>RU 3243-22</b> |
| 24 cm/9 <sup>1</sup> / <sub>2</sub> "  | <b>RU 3240-24</b> | <b>RU 3241-24</b> | <b>RU 3242-24</b> | <b>RU 3243-24</b> |
| 26 cm/10 <sup>1</sup> / <sub>4</sub> " | <b>RU 3240-26</b> | <b>RU 3241-26</b> | <b>RU 3242-26</b> | <b>RU 3243-26</b> |



**Arterienklemmen, Aortaklemmen**  
**Hemostatic Forceps, Aorta Clamps**  
**Pinzas hemostáticas, Pinzas-clamps para aorta**  
**Pinces hémostatiques, Pinces-clamps pour aortes**  
**Pinze emostatiche, Pinze per aorta**

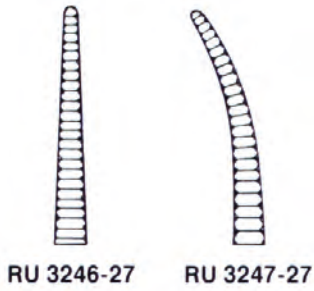

**Bridge**  
 27 cm/10 1/2"

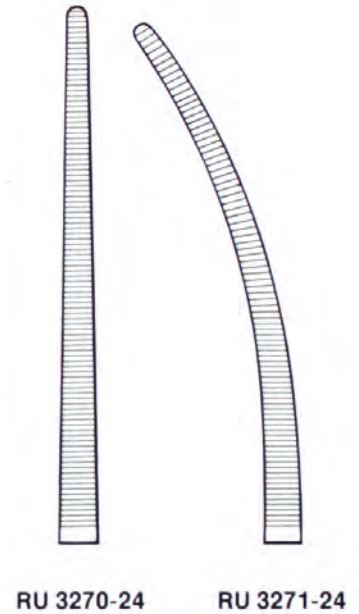

**Sarot**  
 24 cm/9 1/2"

Aortaklemmen  
 Aorta clamps  
 Pinzas-clamps para aorta  
 Pinces-clamps pour aortes  
 Pinze per aorta

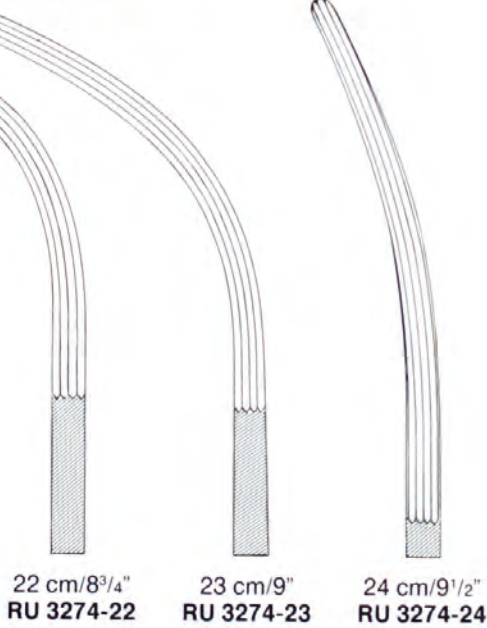

**Crafoord-Sellors**

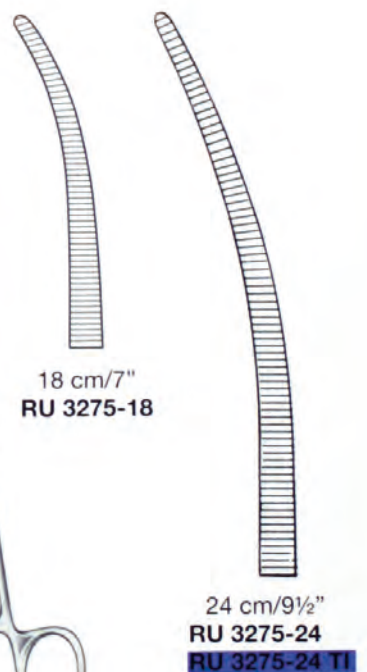

**Crafoord**

TI = TITAN

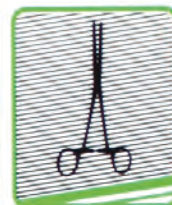

**Harrington**

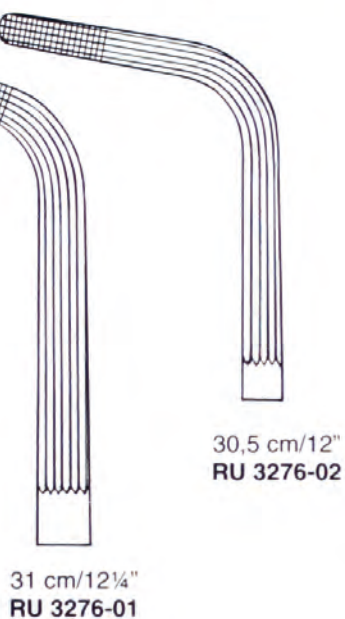

**Kantrowitz**

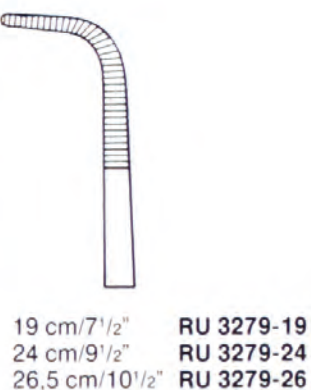

**Rumel**  
 23 cm/9"

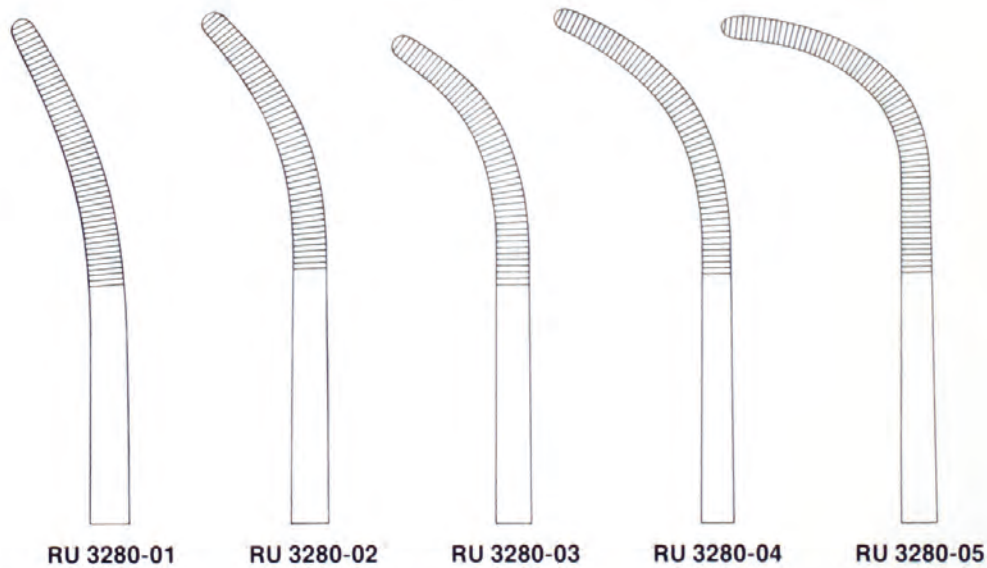



**Präparier- und Ligaturklemmen**  
**Dissecting and Ligature Forceps**  
**Pinzas para preparaciones y ligaduras**  
**Pinces à disséquer et à ligatures**  
**Pinze per dissezione e legature**



**Overholt-S**

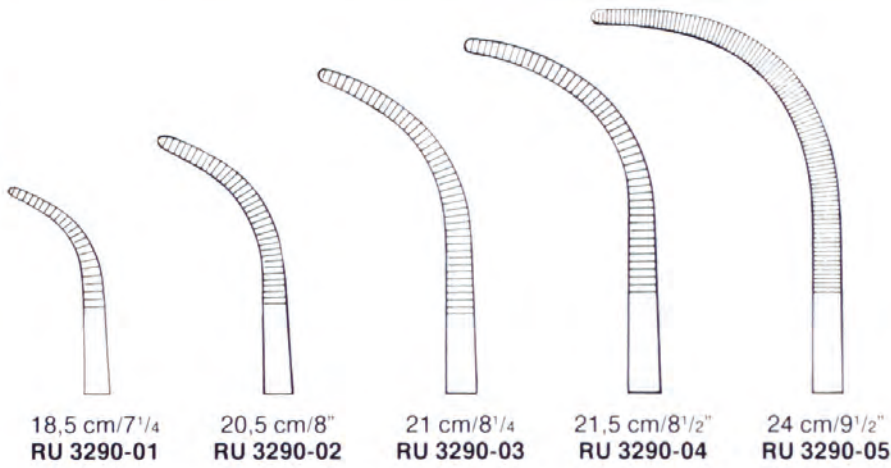

**Overholt-Slim**

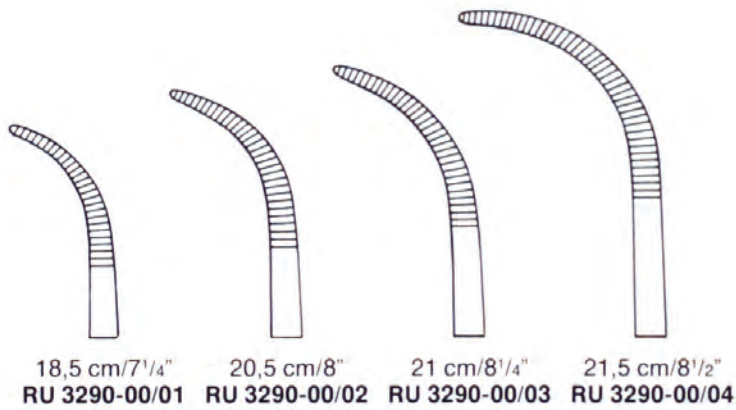



**Präparier- und Ligaturklemmen**  
**Dissecting and Ligature Forceps**  
**Pinzas para preparaciones y ligaduras**  
**Pinces à disséquer et à ligatures**  
**Pinze per dissezione e legature**



**Overholt-Geissendörfer**

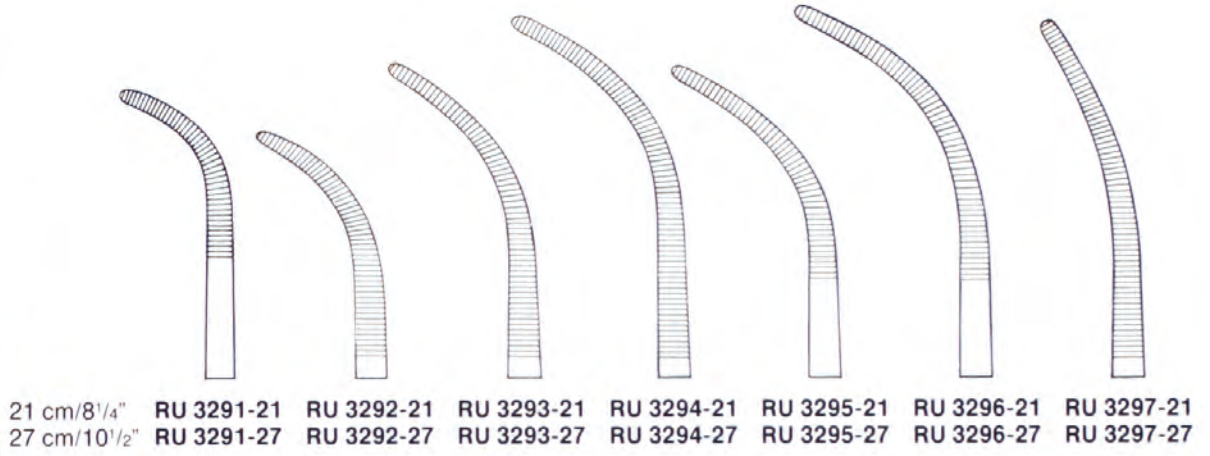

|               |            |            |            |            |            |            |            |
|---------------|------------|------------|------------|------------|------------|------------|------------|
| 21 cm/8 1/4"  | RU 3291-21 | RU 3292-21 | RU 3293-21 | RU 3294-21 | RU 3295-21 | RU 3296-21 | RU 3297-21 |
| 27 cm/10 1/2" | RU 3291-27 | RU 3292-27 | RU 3293-27 | RU 3294-27 | RU 3295-27 | RU 3296-27 | RU 3297-27 |



**Overholt-Mixer**  
 21 cm/8 1/4"  
 RU 3298-21



**Heiss**  
 20 cm/8"

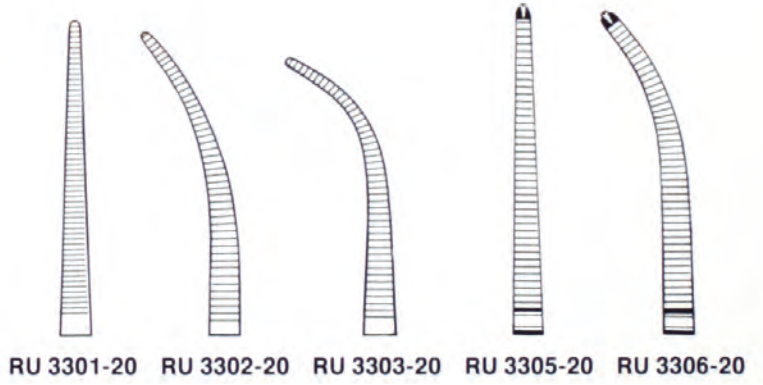

|            |            |            |            |            |
|------------|------------|------------|------------|------------|
| RU 3301-20 | RU 3302-20 | RU 3303-20 | RU 3305-20 | RU 3306-20 |
|------------|------------|------------|------------|------------|



**Präparier- und Ligaturklemmen**  
**Dissecting and Ligature Forceps**  
**Pinzas para preparaciones y ligaduras**  
**Pinces à disséquer et à ligatures**  
**Pinze per dissezione e legature**



**Gemini**

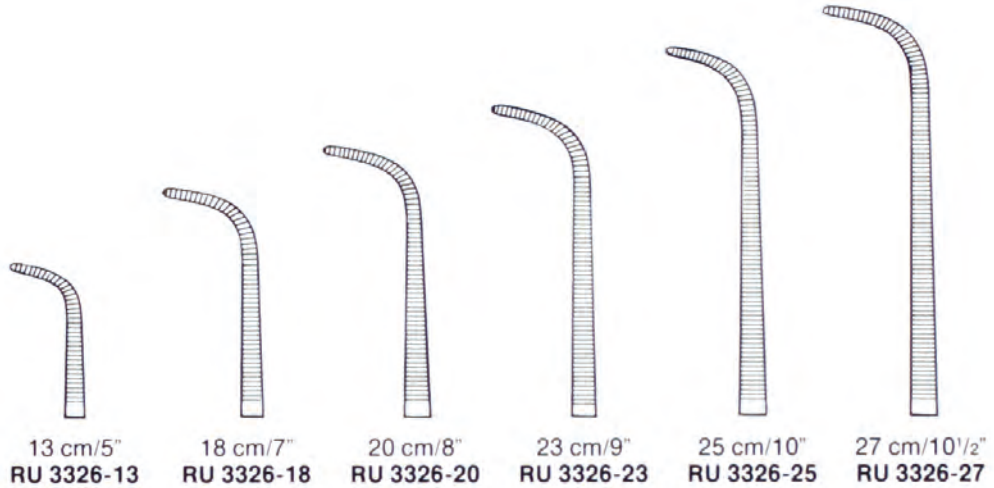

**Mini-Gemini**

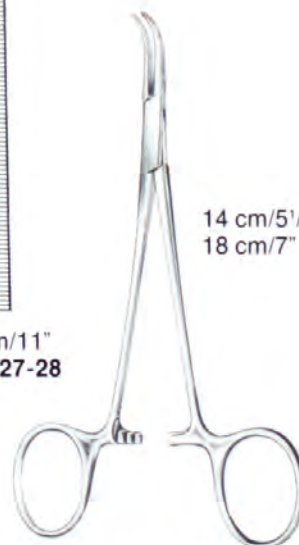
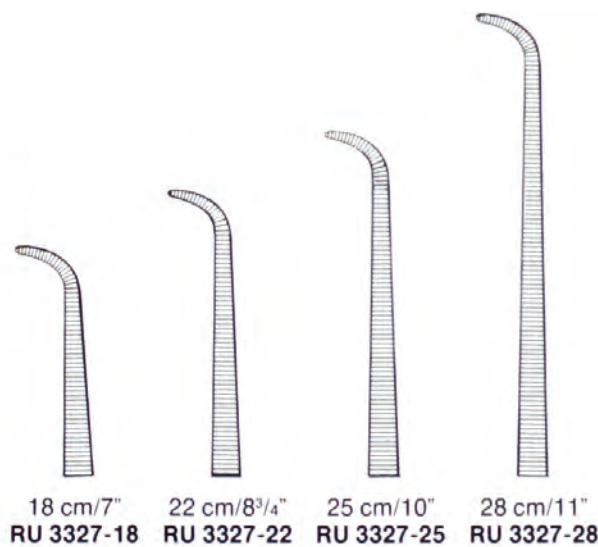

**Baby-Mixer**

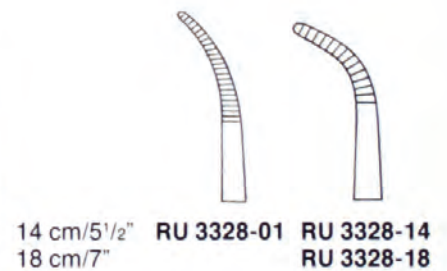

**Präparier- und Ligaturklemmen**  
**Dissecting and Ligature Forceps**  
**Pinzas para preparaciones y ligaduras**  
**Pinces à disséquer et à ligatures**  
**Pinze per dissezione e legature**



Koronar-Arterien-Präparierklemme  
 Coronary artery dissecting clamp  
 Pinzas para preparaciones de arterias coronarias  
 Clamps à disséquer pour les artères coronaires  
 Pinze per dissezione coronari



**Sawtell**  
 18 cm/7"  
 RU 3329-01



18,5 cm/7¼"  
 RU 3329-11



**Mixer O'Shaugnessy**  
 RU 3335-15 15,5 cm/6"  
 RU 3335-19 19 cm/7½"



**Mixer**



22 cm/8¾"  
 RU 3341-22

25 cm/10"  
 RU 3342-25

28 cm/11"  
 RU 3343-28



**Mixer**

22 cm/8¾"  
 RU 3350-22



**Präparier- und Ligaturklemmen**  
**Dissecting and Ligature Forceps**  
**Pinzas para preparaciones y ligaduras**  
**Pinces à disséquer et à ligatures**  
**Pinze per dissezione e legature**



**Wickstroem**  
20 cm/8"  
RU 3351-20



**Lawrence**  
27,5 cm/10¾"  
RU 3355-27



**Lahey (Sweet)**



19 cm/7½"  
RU 3361-19



23 cm/9"  
RU 3361-23

**Bulldogklemmen**  
**Bulldog Clamps**  
**Clamps Bulldog**  
**Clamps Bulldog**  
**Pinze Bulldog**



Federleichte Bulldogklemmen  
 Featherlight Bulldog clamps  
 Clamps Bulldog, ligeros como una pluma  
 Clamps Bulldog poids plume  
 Pinze Bulldog, ultra leggera



**Schwartz**  
 19 cm/7 1/2"  
 RU 3930-80



2,7 cm/1"  
 RU 3930-01



2,7 cm/1"  
 RU 3930-02



2,5 cm/1"  
 RU 3930-03



RU 3932-00



RU 3932-04



RU 3932-08



RU 3932-10



RU 3932-14



RU 3932-18



RU 3934-08



RU 3934-12



RU 3934-16



3,5 cm/1 1/2"  
 RU 7586-10/35



3,5 cm/1 1/2"  
 RU 7586-11/35



**Diethrich**

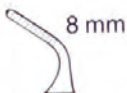

RU 3935-08



RU 3935-12



RU 3935-16

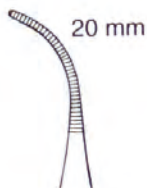

RU 3935-21



RU 3935-22



RU 3935-23



4,5 cm/1 3/4"  
 RU 7586-10/45



4,5 cm/1 3/4"  
 RU 7586-11/45



**Gefäßclips**  
**Vessel Clips**  
**Clips vasculares**  
**Serre-fines**  
**Serrafini**







Clip-Anlegezangen  
 Clip applying forceps  
 Pinzas para poner micro-clips  
 Pincas pour poser les serre-fines  
 Pinze per posizionare micro-clips



14 cm/5 1/2"  
 RU 3940-14



RU 3941-18      18 cm/7"  
 RU 3941-22      22 cm/8 3/4"

| Maullänge<br>length of jaw<br>largo de boca<br>longueur de mors<br>lungh. del morso | Maulbreite<br>width of jaw<br>ancho de boca<br>largeur de mors<br>largh. del morso | Schließdruck<br>occlusion pressure<br>presión de oclusión<br>pression d'occlusion<br>pressione occlusiva |  |     |  |  |
|---|--|--|---|---|---|---|
|   |  |  | gerade<br>straight<br>rectos<br>droites<br>rette                                    | leicht gebogen<br>slightly curved<br>curvos ligeros<br>courbure légère<br>curva leggera | stark gebogen<br>strong curved<br>curvos fuertes<br>courbure forte<br>curva forte     | abgewinkelt<br>angled<br>acodados<br>coudé<br>angolate                                |
| 4 mm  | 0.75 mm  | 125 g  | RU 3950-04  |   |   |   |
| 6 mm  | 1.00 mm  | 100 g  | RU 3950-06  |   |   |   |
| 8 mm  | 2.00 mm  | 85 g   | RU 3950-08  |   |   |   |
| 10 mm   | 2.00 mm  | 60 g   | RU 3950-10  |   |   |   |
| 4 mm  | 0.75 mm  | 150 g  | RU 3955-04  |   |   |   |
| 6 mm  | 1.00 mm  | 150 g  | RU 3955-06  | RU 3956-06  | RU 3957-06  | RU 3958-06  |
| 8 mm  | 2.00 mm  | 150 g  | RU 3955-08  |   |   |   |
| 10 mm   | 2.00 mm  | 150 g  | RU 3955-10  |   |   |   |
| 4 mm  | 0.75 mm  | 70 g   | RU 3960-04  |   |   |   |
| 6 mm  | 0.80 mm  | 70 g   | RU 3960-06  |   |   |   |
| 6 mm  | 1.00 mm  | 70 g   | RU 3960-07  | RU 3966-06  | RU 3967-06  | RU 3968-06  |
| 8 mm  | 1.00 mm  | 70 g   | RU 3960-08  |   |   |   |
| 10 mm   | 1.50 mm  | 70 g   | RU 3960-10  |   |   |   |

**Mikro-Gefäßklemmen**  
**Micro Vascular Clamps**  
**Micro-clamps vasculares**  
**Micro-clamps vasculaires**  
**Micro clips vascolari**



Anlegepinzette für Mikro-Gefäßklemmen RU 3975-396 bis RU 3975-478  
 Applying forceps for micro vascular clamps RU 3975-396 to RU 3975-478  
 Pinzas para aplicar micro-clamps vasculares RU 3975-396 a RU 3975-478  
 Pince à poser les micro-clamps vasculaires RU 3975-396 à RU 3975-478  
 Pinze per posizionare i micro-clips vascolari RU 3975-396 a RU 3975-478



14 cm/5½"

mit Sperre  
 with ratchet  
 con cierre  
 avec verrou  
 con cremagliera

**RU 3975-071**

ohne Sperre  
 without ratchet  
 sin cierre  
 sans verrou  
 senza cremagliera

**RU 3975-072**

V = für Venen  
 for veins  
 para venas  
 pour des veines  
 per vene

A = für Arterien  
 for arteries  
 para arterias  
 pour des artères  
 per arterie

**ACLAND, mod.**

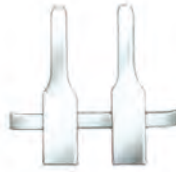

| Gefäßgröße<br>Vessel size<br>Tamaño de vaso<br>Grandeur des vaisseaux<br>Lunghezza del vaso | Einzelklemmen (Paar)<br>Single clamps (pair) | Clamps individuales (par) | Clips singole (paio) | Approximatoren ohne Rahmen, beweglich<br>Approximators without frame, movable<br>Aproximadores sin cuadro, móviles<br>Approximateurs, sans cadre, mobiles<br>Approssimatore, senza quadro, pieghevole | Approximatoren mit Rahmen, beweglich<br>Approximators with frame, movable<br>Aproximadores con cuadro, móviles<br>Approximateurs, avec cadre, mobiles<br>Approssimatore, con quadro pieghevole | Doppelklemmen mit Rahmen<br>Double clamps with frame<br>Clamps dobles con cuadro<br>Clamps doubles avec cadre<br>Clips doppie con quadro | Doppelklemmen ohne Rahmen<br>Double clamps without frame<br>Clamps dobles sin cuadro<br>Clamps doubles sans cadre<br>Clips doppie senza quadro | Approximatoren mit Rahmen, beweglich<br>Approximators with frame, movable<br>Aproximadores con cuadro, móviles<br>Approximateurs, avec cadre, mobiles<br>Approssimatore, con quadro pieghevole | Approximatoren ohne Rahmen, beweglich<br>Approximators without frame, movable<br>Aproximadores sin cuadro, móviles<br>Approximateurs, sans cadre, mobiles<br>Approssimatore, senza quadro, pieghevole |
|---|--|---------------------------|----------------------|---|--|--|--|--|---|
|   | V  | A                         | V                    | A   | V  | A  | V  | A  |   |
| Matt/plain<br>mate/éteint/<br>opaco   |  |                           |                      |   |  |  |  |  |   |
| 0,4–1,0 mm  | <b>RU 3975-396</b>                           | <b>RU 3975-397</b>        | <b>RU 3975-414</b>   | <b>RU 3975-415</b>  | <b>RU 3975-402</b>   | <b>RU 3975-403</b>   | <b>RU 3975-408</b>   | <b>RU 3975-409</b>   |   |
| 0,6–1,5 mm  | <b>RU 3975-398</b>                           | <b>RU 3975-399</b>        | <b>RU 3975-416</b>   | <b>RU 3975-417</b>  | <b>RU 3975-404</b>   | <b>RU 3975-405</b>   | <b>RU 3975-410</b>   | <b>RU 3975-411</b>   |   |
| 1,0–2,25 mm   | <b>RU 3975-400</b>                           | <b>RU 3975-401</b>        | <b>RU 3975-418</b>   | <b>RU 3975-419</b>  | <b>RU 3975-406</b>   | <b>RU 3975-407</b>   | <b>RU 3975-412</b>   | <b>RU 3975-413</b>   |   |
| 1,5–3,5 mm  | <b>RU 3975-325</b>                           |                           | <b>RU 3975-326</b>   |   |  |  |  |  |   |
| 2,0–5,0 mm  | <b>RU 3975-286</b>                           |                           | <b>RU 3975-287</b>   |   |  |  |  |  |   |
| Schwarz/black<br>negro/noir/nero  |  |                           |                      |   |  |  |  |  |   |
| 0,4–1,0 mm  | <b>RU 3975-462</b>                           | <b>RU 3975-461</b>        | <b>RU 3975-480</b>   | <b>RU 3975-479</b>  | <b>RU 3975-468</b>   | <b>RU 3975-467</b>   | <b>RU 3975-474</b>   | <b>RU 3975-473</b>   |   |
| 0,6–1,5 mm  | <b>RU 3975-464</b>                           | <b>RU 3975-463</b>        | <b>RU 3975-482</b>   | <b>RU 3975-481</b>  | <b>RU 3975-470</b>   | <b>RU 3975-469</b>   | <b>RU 3975-476</b>   | <b>RU 3975-475</b>   |   |
| 1,0–2,25 mm   | <b>RU 3975-466</b>                           | <b>RU 3975-465</b>        | <b>RU 3975-484</b>   | <b>RU 3975-483</b>  | <b>RU 3975-472</b>   | <b>RU 3975-471</b>   | <b>RU 3975-478</b>   | <b>RU 3975-477</b>   |   |
| 1,5–3,5 mm  | <b>RU 3975-329</b>                           |                           | <b>RU 3975-330</b>   |   |  |  |  |  |   |
| 2,0–5,0 mm  | <b>RU 3975-327</b>                           |                           | <b>RU 3975-328</b>   |   |  |  |  |  |   |



**Mikro-Gefäßclips**  
**Micro Vessel Clips**  
**Micro-clips vasculares**  
**Micro-serre-fines**  
**Micro-serrafini**



Temporäre Gefäßclips mit atraumatischem Maulprofil  
 Non-traumatic vessel clips, temporary  
 Clips vasculares atraumaticos, temporarios  
 Serre-fines atraumatiques, temporaires  
 Serrafini cardiovascolare atraumatiche, temporaneo



**Müller** 50 g **RU 3977-010** **RU 3977-011** **RU 3977-012** **RU 3977-013** **RU 3977-014**  
 80 g **RU 3977-020** **RU 3977-021** **RU 3977-022** **RU 3977-023** **RU 3977-024**

Anlegepinzette  
 Applying forceps  
 Pinzas para poner micro-clips  
 Pince à poser les clips  
 Pinze per posizionare micro clips



15 cm/6"  
**RU 3977-078**

|  | Maullänge<br>length of jaw<br>largo de boca<br>longueur de mors<br>lunghezza del morso | Maulbreite<br>width of jaw<br>ancho de boca<br>largeur de mors<br>larghezza del morso | Schließdruck<br>occlusion pressure<br>presión de oclusión<br>pression d'occlusion<br>pressione occlusiva | Artikelnummer<br>Reference no.<br>Referencia No.<br>Référence<br>No d'articolo |
|---|--|---|--|--|
|  | 4 mm   | 1 mm  | 10 – 15 g  | <b>RU 3977-052</b>   |
|  | 4 mm   | 1,4 mm  | 15 – 20 g  | <b>RU 3977-054</b>   |
|  | 6 mm   | 1 mm  | 10 – 15 g  | <b>RU 3977-056</b>   |
|  | 6 mm   | 1,4 mm  | 15 – 20 g  | <b>RU 3977-058</b>   |



**Mikro-Gefäßclips und Approximatoren**  
**Micro Vessel Clips and Approximators**  
**Micro-clips vasculares y aproximadores**  
**Micro-serre-fines et approximateurs**  
**Micro-serrafini ed approssimatori**



| <b>Biemer</b><br>Mikro-Gefäßclips<br>Micro vessel clips<br>Micro-clips vasculares<br>Micro-serre-fines<br>Micro-serrafini | Maullänge<br>length of jaw<br>largo de boca<br>longueur de mors<br>lungh. del morso | Maulbreite<br>width of jaw<br>ancho de boca<br>largeur de mors<br>largh. del morso | Schließdruck<br>occlusion pressure<br>presión de oclusión<br>pression d'occlusion<br>pressione occlusiva | Artikelnummer<br>Reference no.<br>Referencia No.<br>Référence<br>No d'articolo |
|---|---|--|--|--|
|   | 6 mm  | 4 mm   | 30 – 40 g  | <b>RU 3977-060</b>   |
|   | 9 mm  | 5 mm   | 30 – 40 g  | <b>RU 3977-061</b>   |
|   | 9 mm  | 5 mm   | 20 – 25 g  | <b>RU 3977-062</b>   |

| <b>Biemer-Müller</b><br>Mikro-Approximatoren<br>Micro approximators<br>Micro-aproximadores<br>Micro approximateurs<br>Micro-approssimatori |        |      |           |                    |
|--|--------|------|-----------|--------------------|
|  | 9 mm   | 5 mm | 25 – 30 g | <b>RU 3977-111</b> |
|  | 9 mm   | 5 mm | 25 – 30 g | <b>RU 3977-112</b> |
|  | 9 mm   | 5 mm | 25 – 30 g | <b>RU 3977-113</b> |
|  | 9 mm   | 5 mm | 25 – 30 g | <b>RU 3977-114</b> |
|  | 4,5 mm | 3 mm | 25 – 30 g | <b>RU 3977-115</b> |

| <b>Müller</b><br>Approximatoren mit 3/8 Kreis-Maulbogen für feste Rundkörper<br>Approximators with 3/8 jaw curve for solid trunks<br>Aproximadores con círculo de boca 3/8 para cuerpos redondos<br>Approximateurs avec mors 3/8 cercle pour des corps ronds<br>Approssimatori con morsi 3/8 cerchio per corpi rotondi |           |           |                    |
|--|-----------|-----------|--------------------|
|  | Ø<br>1 mm | 25 – 30 g | <b>RU 3977-171</b> |
|  | 2 mm      | 25 – 30 g | <b>RU 3977-172</b> |
|  | 3 mm      | 25 – 30 g | <b>RU 3977-173</b> |
|  | 4 mm      | 25 – 30 g | <b>RU 3977-174</b> |



14 cm/5½"  
ohne Schloß  
without catch  
sin cierre  
sans arrêt  
senza cremagliera  
**RU 3977-068**

mit Schloß  
with catch  
con cierre  
avec arrêt  
con cremagliera  
**RU 3977-069**



**Pinzetten**  
**Dissecting Forceps**  
**Pinzas de disección**  
**Pinces à disséquer**  
**Pinze anatomiche**



Atrauma-Pinzetten siehe Seite 113, 114  
Atraumatic dissecting forceps see page 113, 114  
Atrauma pinzas de disección ver página 113, 114  
Pinces à disséquer atraumatiques voir page 113, 114  
Pinze atraumatiche, vedere pagina 113, 114

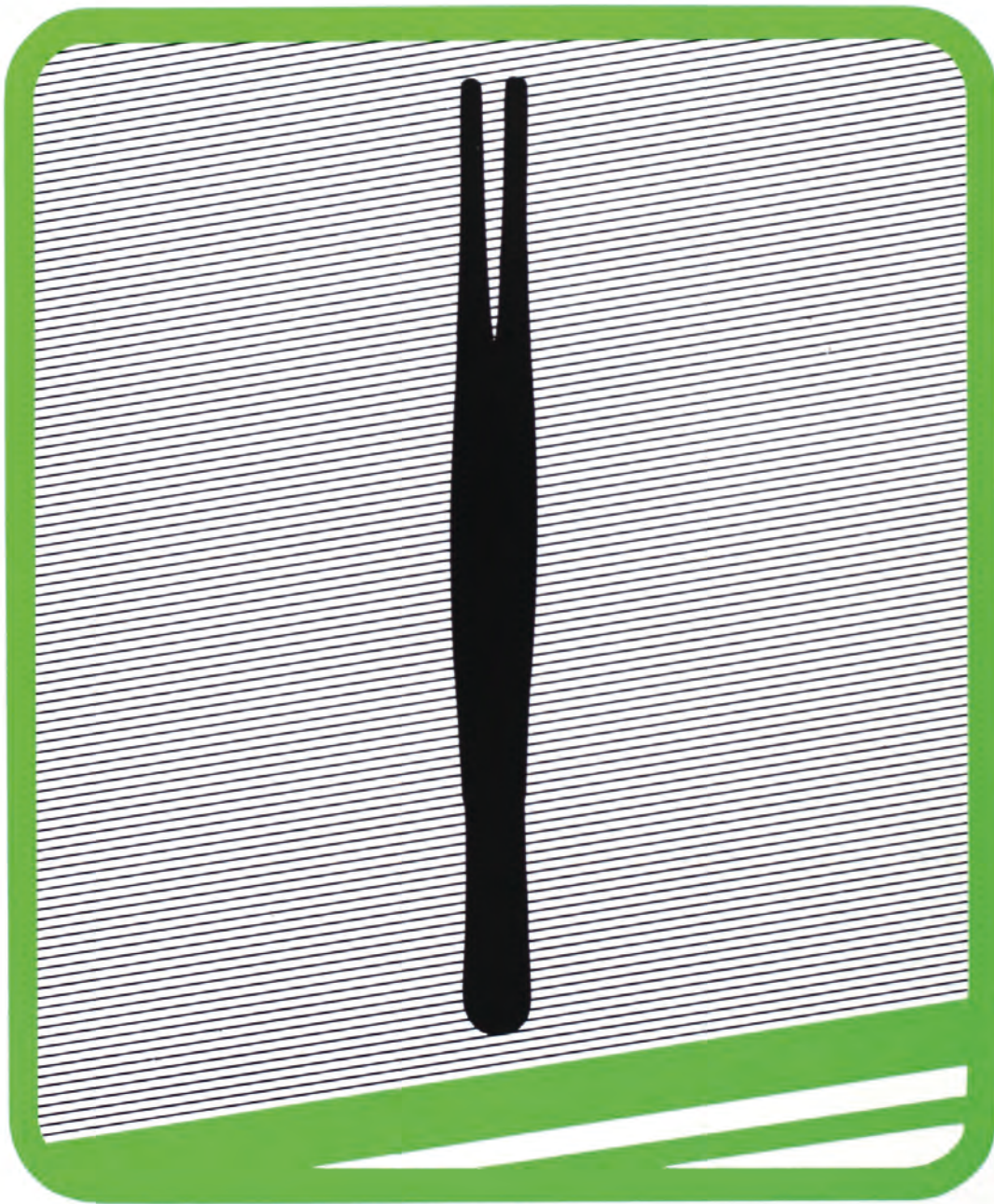



**Mikro-Grip Pinzetten**  
**Micro Grip Forceps**  
**Micro-Grip Pinzas de disección**  
**Pinces à disséquer Micro-Grip**  
**Pinze Micro-Grip**



**Rudolf**  
**MIKRO-GRIP**



gerade  
 straight  
 rectas  
 droits  
 rette



gebogen  
 curved  
 curvas  
 courbes  
 curve



Ringpinzetten  
 Ring forceps  
 Pinzas de anillo  
 Pincers annulaires  
 Pinze micro con anelli

|           |                   |                   |
|-----------|-------------------|-------------------|
| 15 cm/6"  | <b>RU 4068-51</b> | <b>RU 4068-52</b> |
| 18 cm/7"  | <b>RU 4068-53</b> | <b>RU 4068-54</b> |
| 21 cm/8¼" | <b>RU 4068-55</b> | <b>RU 4068-56</b> |

|            |                   |
|------------|-------------------|
| 17,5 cm/7" | <b>RU 4068-57</b> |
| 21 cm/8¼"  | <b>RU 4068-58</b> |



**Ira**  
 18 cm/7"  
**RU 4068-63**  
**RU 4068-63 TI**



**Adson**  
 12 cm/4¾"  
**RU 4068-71**



**McIndoe**  
 15 cm/6"  
**RU 4068-72**

**TI = TITAN**



**Anatomische Pinzetten, Mikro-Pinzetten**  
**Dressing Forceps, Micro Forceps**  
**Pinzas de disección, Micro-pinzas**  
**Pinces à disséquer, Micro-pinces**  
**Pinze anatomiche, Micro-Pinze**

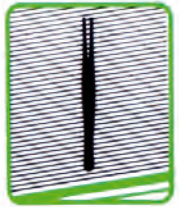

**Rudolf**  
TC



**Rudolf**  
TC



**Standard**  
 14,5 cm/5¾"  
 16,0 cm/6¼"  
 18,0 cm/7"  
 20,0 cm/8"  
 25,0 cm/10"  
**RU 4002-14**  
**RU 4002-16**  
**RU 4002-18**  
**RU 4002-20**  
**RU 4002-25**

**Adson**  
**Standard**  
 12 cm/4¾"  
**RU 4035-12**  
**RU 4035-12 TI**

**Adson**  
 12 cm/4¾"  
 15 cm/6"  
**RU 4036-12**  
**RU 4036-15**

**McIndoe**  
 15 cm/6"  
**RU 4038-15**  
**RU 4038-15 TI**



gebogen  
 curved  
 curvas  
 courbes  
 curve



**Gerald**

| cm   | in |                   |                   |                   |   |
|------|----|-------------------|-------------------|-------------------|---|
| 12,0 | 4¾ |                   |                   | <b>RU 4068-12</b> | <b>RU 4069-12</b>                         |
| 13,0 | 5  |                   | <b>RU 4066-13</b> | <b>RU 4067-13</b> |   |
| 15,0 | 6  | <b>RU 4065-15</b> |                   | <b>RU 4068-15</b> | <b>RU 4069-15</b>                         |
| 17,5 | 7  |                   |                   |                   | <b>RU 4070-17</b><br><b>RU 4070-17 TI</b> |
| 18,0 | 7  | <b>RU 4065-18</b> |                   | <b>RU 4068-18</b> | <b>RU 4069-18</b>                         |

**TI = TITAN**



**Mikro-Pinzetten, Tumorfaßpinzetten**  
**Micro Forceps, Tumor Grasping Forceps**  
**Micro-pinzas, Pinzas para tumores**  
**Micro-pinces, Pinces pour tumeurs**  
**Micro-pinze, Pinze per tumore**



**Rudolf**  
TITAN



18 cm/7"



0,4 mm  
RU 4062-18/04 TI



0,8 mm  
RU 4062-18/08 TI



0,4 mm  
RU 4063-18/04 TI



0,8 mm  
RU 4063-18/08 TI



6 x 0,4 mm  
RU 4068-18/04 TI



6 x 0,8 mm  
RU 4068-18/08 TI



6 x 0,4 mm  
RU 4069-18/04 TI



6 x 0,8 mm  
RU 4069-18/08 TI



6 x 0,4 mm  
RU 4086-18/04 TI



6 x 0,8 mm  
RU 4086-18/08 TI



6 x 0,4 mm  
RU 4087-18/04 TI



6 x 0,8 mm  
RU 4087-18/08 TI



18 cm/7"



1 x 0,5 mm  
RU 4079-18/01 TI

2 x 1,0 mm

RU 4079-18/03 TI



1 x 0,5 mm  
RU 4079-18/02 TI

2 x 1,0 mm

RU 4079-18/04 TI

TI = TITAN



**Anatomische Pinzetten Mikro-Knüpfpinzetten, Faßpinzetten  
 Dressing Forceps, Micro Suture Tying Forceps, Grasping Forceps  
 Pinzas de disección, Micro-pinzas para sutura, Pinzas para coger  
 Pincers à disséquer, Micro-pincers à sutures, Pincers à saisir  
 Pinze anatomiche, Micro-pinze per sutura, Pinze per afferrare tessuti**

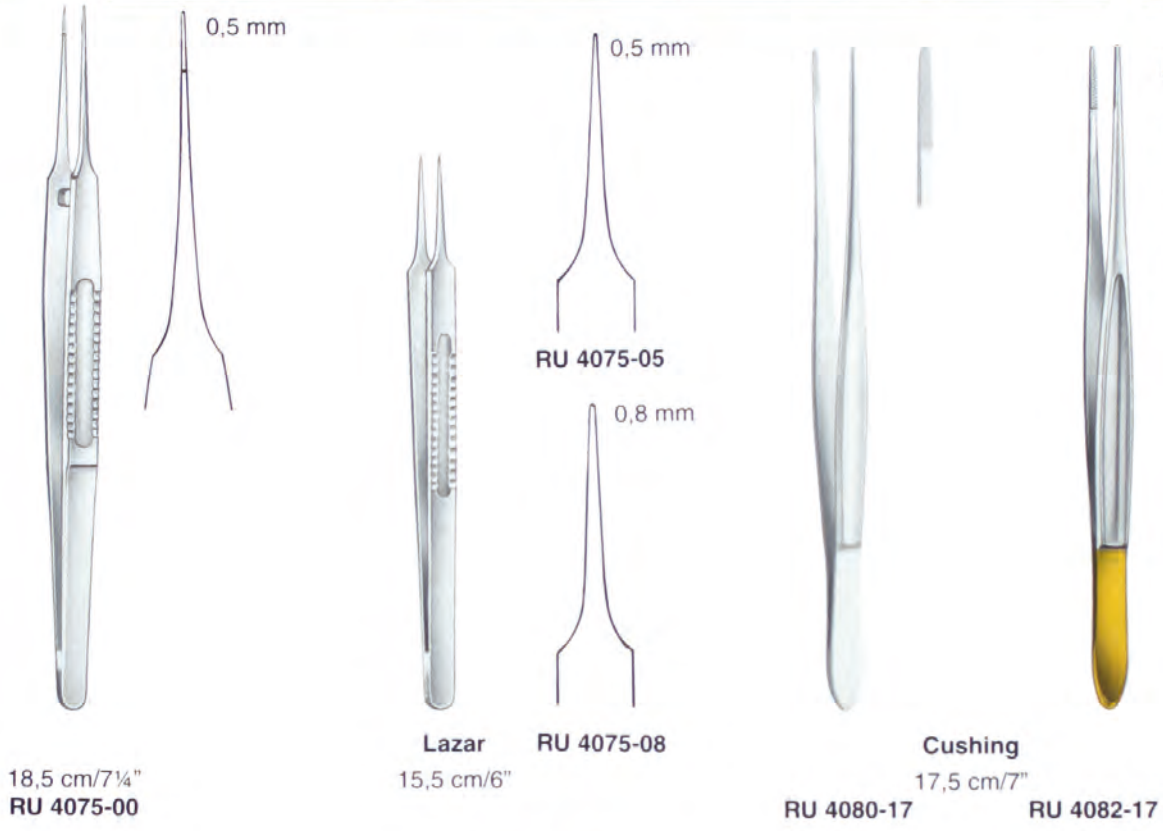
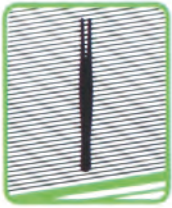

| cm | in |            | Wangenstein | Potts-Smith |
|----|----|------------|-------------|-------------|
| 15 | 6  |            | RU 4085-15  | RU 4092-15  |
| 18 | 7  | RU 4083-17 |             | RU 4092-18  |
| 20 | 8  |            |             | RU 4092-20  |
| 23 | 9  |            | RU 4085-23  | RU 4092-23  |
| 25 | 10 |            | RU 4085-25  | RU 4092-25  |

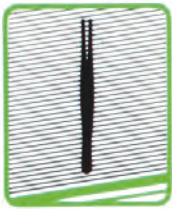

Chirurgische Pinzetten, Lungenfaßpinzetten  
 Tissue Forceps, Lung Grasping Forceps  
 Pinzas de disección con dientes, Pinzas para coger pulmones  
 Pincers à griffes, Pincers à saisir les poumons  
 Pinze chirurgiche a denti di topo, Pinze per polmone



1:2  
↔



**Adson**

12 cm/4¾"

RU 4135-12

RU 4135-12 TI

1:2



**Adson**

12 cm/4¾"

RU 4136-12

↔



**Adson-Brown**

12 cm/4¾"

RU 4137-12

RU 4137-12 TI

↔



**Gillies**

15 cm/6"

RU 4138-15

RU 4138-15 TI



**Gerald**

18 cm/7"

RU 4170-18

RU 4170-18 TI

TI = TITAN

Lungen- und Gewebefaßzangen  
 Lung and tissue grasping forceps  
 Pinzas para coger pulmones y tejidos  
 Pincers à saisir les poumons et la tissue  
 Pinze per polmone e pinze per afferrare tessuti



**Mayo**

23 cm/9"

RU 4221-23

Lungenfaßpinzetten  
 Lung grasping forceps  
 Pinzas para coger pulmones  
 Pincers à saisir les poumons  
 Pinze per polmone



**Nelson**

23 cm/9"

RU 4235-23



**Singley-Tuttle**

23 cm/9"

RU 4236-23



Wundhaken, Wundsperrer  
Retractors, Self-retaining Retractors  
Separadores y ganchos, Separadores  
Ecarteurs et crochets  
Divaricatori ed Uncini

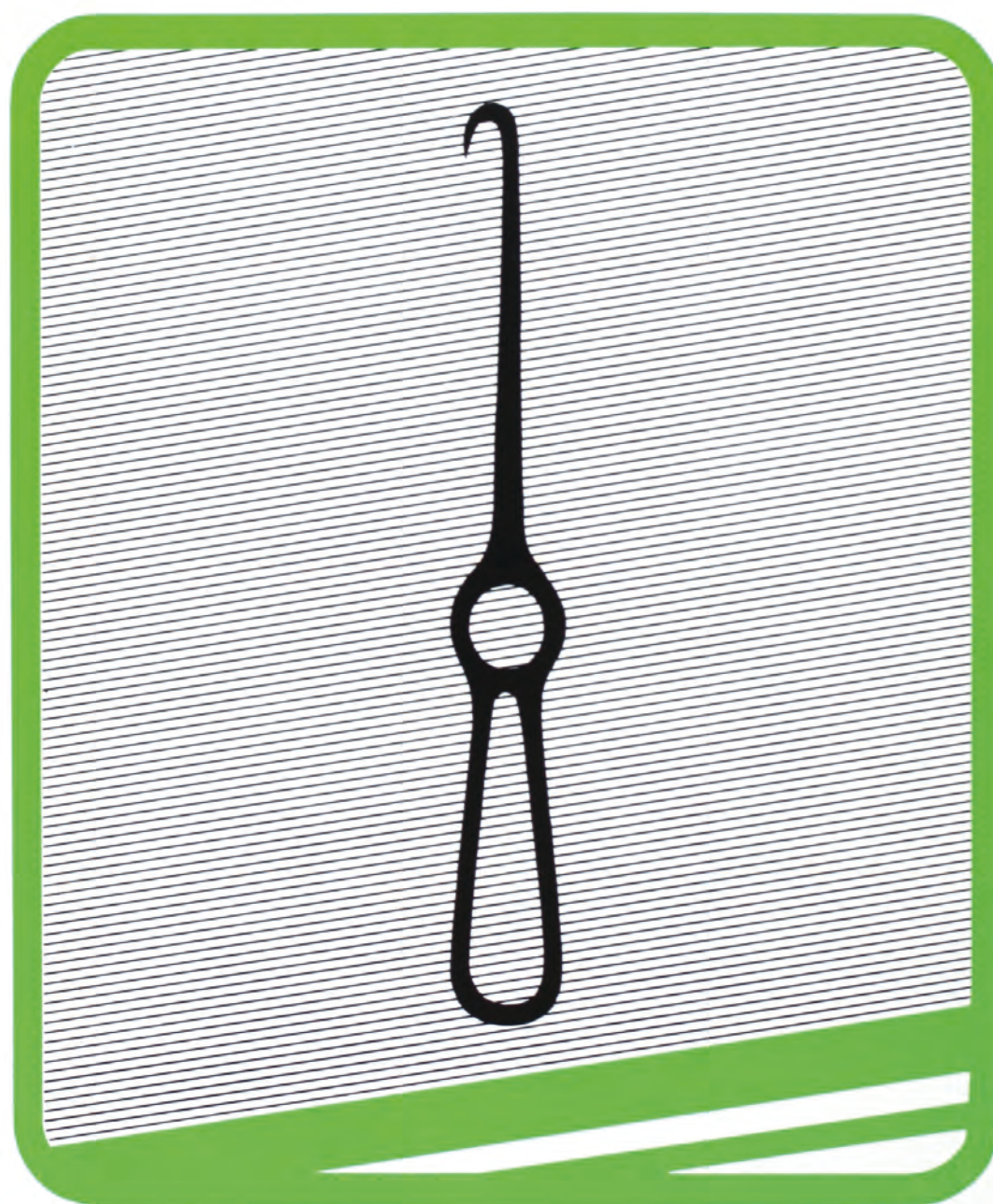



**Gefäß- und Wundhäkchen**  
**Vessel and Wound Retractors**  
**Ganchos, Ganchos vasculares**  
**Crochets à veines, Crochets fins**  
**Divaricatori, Uncini vascolari**



biegsam  
flexible  
maleables  
malléables  
malleabili



**Gil-Vernet**  
24 cm/9 1/2"

12x14 mm



**Little**  
20 cm/8"  
RU 4455-20



**Love (Morse)**  
25 cm/10"

- 10 mm RU 4456-10
- 15 mm RU 4456-15
- 20 mm RU 4456-20
- 30 mm RU 4456-30
- 40 mm RU 4456-40
- 50 mm RU 4456-50



**Cushing**  
25 cm/10"



11 x 14 mm  
RU 4456-81



13 x 18 mm  
RU 4456-82



15 x 22 mm  
RU 4456-83

|       |            |
|-------|------------|
| 8 mm  | RU 4449-08 |
| 11 mm | RU 4449-11 |
| 15 mm | RU 4449-15 |
| 17 mm | RU 4449-17 |
| 20 mm | RU 4449-20 |
| 23 mm | RU 4449-23 |





**Wundhaken, Knochenhaken**  
**Retractors, Bone Retractors**  
**Separadores, Separadores para huesos**  
**Crochets, Ecarteurs à os**  
**Divaricatori, Divaricatori ossea**



scharf  
sharp  
agudo  
pointu  
acuto

**Volkmann**  
22 cm/8<sup>3</sup>/<sub>4</sub>"  
RU 4500-01



stumpf  
blunt  
romo  
mousse  
smusso

**Volkmann**  
22 cm/8<sup>3</sup>/<sub>4</sub>"  
RU 4501-01



scharf  
sharp  
agudo  
pointu  
acuto

24 cm/9<sup>1</sup>/<sub>2</sub>"  
RU 4506-24



55 x 20 mm  
RU 4522-01  
63 x 20 mm  
RU 4522-02  
60 x 20 mm  
RU 4522-05

**Langenbeck**  
21 cm/8<sup>1</sup>/<sub>4</sub>"



19 x 12 mm  
RU 4536-01  
21 x 15 mm  
RU 4536-02

**Kocher**  
19 cm/7<sup>1</sup>/<sub>2</sub>"



30 x 11 mm RU 4530-01  
30 x 14 mm RU 4530-02  
30 x 14 mm RU 4530-03  
30 x 16 mm RU 4530-04  
40 x 11 mm RU 4530-05  
42 x 13 mm RU 4530-06  
50 x 11 mm RU 4530-07

**Langenbeck**  
21 cm/8<sup>1</sup>/<sub>4</sub>"



25 x 6 mm RU 4538-11  
25 x 8 mm RU 4538-12  
35 x 8 mm RU 4538-13  
35 x 11 mm RU 4538-14  
35 x 15 mm RU 4538-15  
40 x 11 mm RU 4538-16  
55 x 11 mm RU 4538-17  
70 x 14 mm RU 4538-18  
80 x 12 mm RU 4538-19  
80 x 16 mm RU 4538-20

**Kocher-Langenbeck**  
21,5 cm/8<sup>1</sup>/<sub>2</sub>"

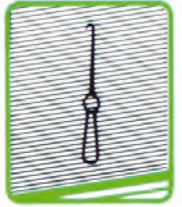

**Crawford**  
19 cm/7½"



15 x 15 mm  
RU 4547-01

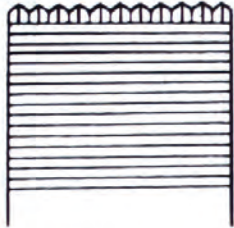

15 x 23 mm  
RU 4547-02



**Simon**  
28 cm/11"

115 x 22 mm  
RU 4560-01  
115 x 27 mm  
RU 4560-02



**Martin**  
26 cm/10¼"

105 x 27 mm



**Mikulicz**  
26 cm/10¼"

85 x 35 mm  
RU 4565-01  
120 x 50 mm  
RU 4565-02  
155 x 50 mm  
RU 4565-03



**Kelly**  
27 cm/10½"

160 x 38 mm  
RU 4567-01  
160 x 57 mm  
RU 4567-02  
190 x 38 mm  
RU 4567-51  
190 x 57 mm  
RU 4567-52



**Wundhaken, Lungenspatel**  
**Retractors, Lung Spatulas**  
**Separadores, Espátulas pulmonares**  
**Ecarteurs, Spatules pulmonaires**  
**Divaricatori, Spatole per polmone**



115 × 65 mm  
RU 4568-03

115 × 38 mm  
RU 4568-02

82 × 20 mm  
RU 4568-01

**Coryllos**  
22,5 cm/9"



130 × 38 mm  
RU 4569-25

**Sauerbruch**  
25 cm/10"



19 mm

22 mm

25 mm

25 mm

38 mm  
RU 4570-07  
50 mm  
RU 4570-08  
75 mm  
RU 4570-09

**Deaver**  
18 cm/7"  
RU 4570-01

**Deaver**  
21,5/8 1/2"  
RU 4570-02

**Deaver**  
23 cm/9"  
RU 4570-03

**Deaver**  
30 cm/12" RU 4570-04  
33 cm/13" RU 4570-05  
36 cm/14" RU 4570-06

**Deaver**  
30 cm/12"

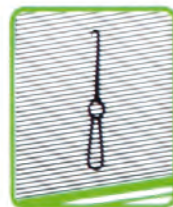

25 mm RU 4571-04  
 38 mm RU 4571-07  
 50 mm RU 4571-08  
 75 mm RU 4571-09

**Deaver Grip-Handle**  
 30 cm/12"



**Harrington-Baby**  
 25 cm/10"  
 24 x 70 mm RU 4572-00

**Harrington**  
 32 cm/12<sup>1</sup>/<sub>2</sub>"  
 40 x 127 mm RU 4572-01  
 62 x 127 mm RU 4572-02

**Harrington-Pemberton**  
 29,5 cm/11,5"  
 64 x 175 mm RU 4572-51



**Zenker**

|  |             |            |
|--|-------------|------------|
| 25 cm/10"                                | 35 x 8 mm   | RU 4574-01 |
| 26 cm/10 <sup>1</sup> / <sub>4</sub> "   | 60 x 12 mm  | RU 4574-02 |
| 27,5 cm/10 <sup>3</sup> / <sub>4</sub> " | 75 x 12 mm  | RU 4574-03 |
| 29 cm/11 <sup>1</sup> / <sub>2</sub> "   | 120 x 12 mm | RU 4574-04 |



20 mm  
 RU 4578-20  
 30 mm  
 RU 4578-30  
 40 mm  
 RU 4578-40

**Kader**  
 27 cm/10<sup>3</sup>/<sub>4</sub>"



Wundhaken, Lungenspatel, Atriumhaken, Aortenklappenhaken  
 Retractors, Lung Spatulas, Atrium Retractors, Aorta Valve Retractors  
 Separadores, Espátulas pulmonares, Separadores para aurícula, Ganchos para aorta  
 Ecarteurs, Spatules pulmonaires, Ecarteurs pour auricules cardiaques, Crochets aortiques  
 Divaricatori, Spatole per polmone, Divaricatori auricolare, Divaricatori per aorta



Atriumhaken  
 Atrium retractors  
 Separadores para aurícula  
 Ecarteurs pour auricules cardiaques  
 Divaricatori auricolare



**Davidson**  
16 cm/6 1/4"

75 x 50 mm  
75 x 90 mm

**RU 4590-01**  
**RU 4590-02**



rechts  
right  
a la derecha  
à droite  
destra

**Cooley**  
21,5 cm/8 1/2"  
**RU 4591-01**



rechts, leicht gezahnt  
right, slightly serrated  
a la derecha, ligeramente dentado  
à droite, légèrement dentelé  
destra, dentellate leggermente

**Cooley**  
21,5 cm/8 1/2"  
**RU 4591-02**



links  
left  
a la izquierda  
à gauche  
sinistra

**Cooley**  
23 cm/9"  
**RU 4591-03**



**Ross**  
24,5 cm/9 1/2"

Aortenklappenhaken  
Aorta valve retractors  
Ganchos para aorta  
Crochets aortiques  
Divaricatori per aorta

- Fig. 1 15 x 16 mm **RU 4593-01**
- Fig. 2 13 x 23 mm **RU 4593-02**
- Fig. 3 17 x 23 mm **RU 4593-03**
- Fig. 4 13 x 27 mm **RU 4593-04**
- Fig. 5 29 x 29 mm **RU 4593-05**
- Fig. 6 40 x 21 mm **RU 4593-06**



**Borowski**  
27 cm/10 1/2"

Schaft biegsam  
flexible shaft  
Vástago maleable  
tige malléable  
Asta malleabile

- 17 x 21 mm **RU 4593-21**
- 16 x 23 mm **RU 4593-22**
- 20 x 25 mm **RU 4593-23**
- 24 x 27 mm **RU 4593-24**
- 28 x 20 mm **RU 4593-25**
- 28 x 29 mm **RU 4593-26**







**Alm**

scharf · sharp    stumpf · blunt  
agudos · pointus    romos · mousses  
acuti                          smussi

| cm | in                            |            |            |
|----|-------------------------------|------------|------------|
| 7  | 2 <sup>3</sup> / <sub>4</sub> | RU 4650-07 | RU 4651-07 |
| 10 | 4                             | RU 4650-10 | RU 4651-10 |



**Weitlaner**

scharf            stumpf  
sharp            blunt  
agudos          romos  
pointus        mousses  
acuti            smussi



**Cone  
(Adson-Baby)**

scharf            stumpf  
sharp            blunt  
agudos          romos  
pointus        mousses  
acuti            smussi



**Adson**

33 cm/13"  
RU 4743-33

13 cm/5"    **RU 4700-13**    **RU 4701-13**  
16 cm/6<sup>1</sup>/<sub>4</sub>"    **RU 4700-16**    **RU 4701-16**

**RU 4722-13**    **RU 4723-13**  
**RU 4722-16**    **RU 4723-16**



Wundhaken, Lungenspatel  
 Retractors, Lung Spatulas  
 Separadores, Espátulas pulmonares  
 Ecarteurs, Spatules pulmonaires  
 Divaricatori, Spatole per polmone



3 x 4 Zähne  
 3 x 4 teeth  
 3 x 4 dientes  
 3 x 4 dents  
 3 x 4 denti

scharf  
 sharp  
 agudos  
 pointus  
 acuti

stumpf  
 blunt  
 romos  
 mousses  
 smussi

20 cm/8" **RU 4724-20** **RU 4725-20**  
 25 cm/9 1/2" **RU 4724-25** **RU 4725-25**

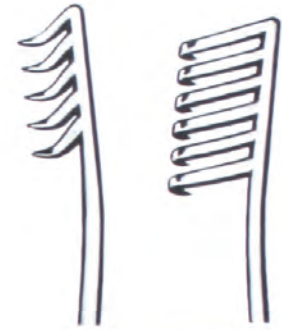

5 x 6 Zähne  
 5 x 6 teeth  
 5 x 6 dientes  
 5 x 6 dents  
 5 x 6 denti

scharf  
 sharp  
 agudo  
 pointu  
 acuti

stumpf  
 blunt  
 romo  
 mousse  
 smussi

**RU 4726-25** **RU 4727-25**



Lungenspatel  
 Lung spatulas  
 Espátulas pulmonares  
 Spatules pulmonaires  
 Spatole per polmone

**Allison**

25,5 cm/10" **RU 7538-25**  
 30 cm/12" **RU 7538-30**

Gefäßinstrumente  
Vessel Instruments  
Instrumental vascular  
Instruments pour vaisseaux  
Strumenti vascolari

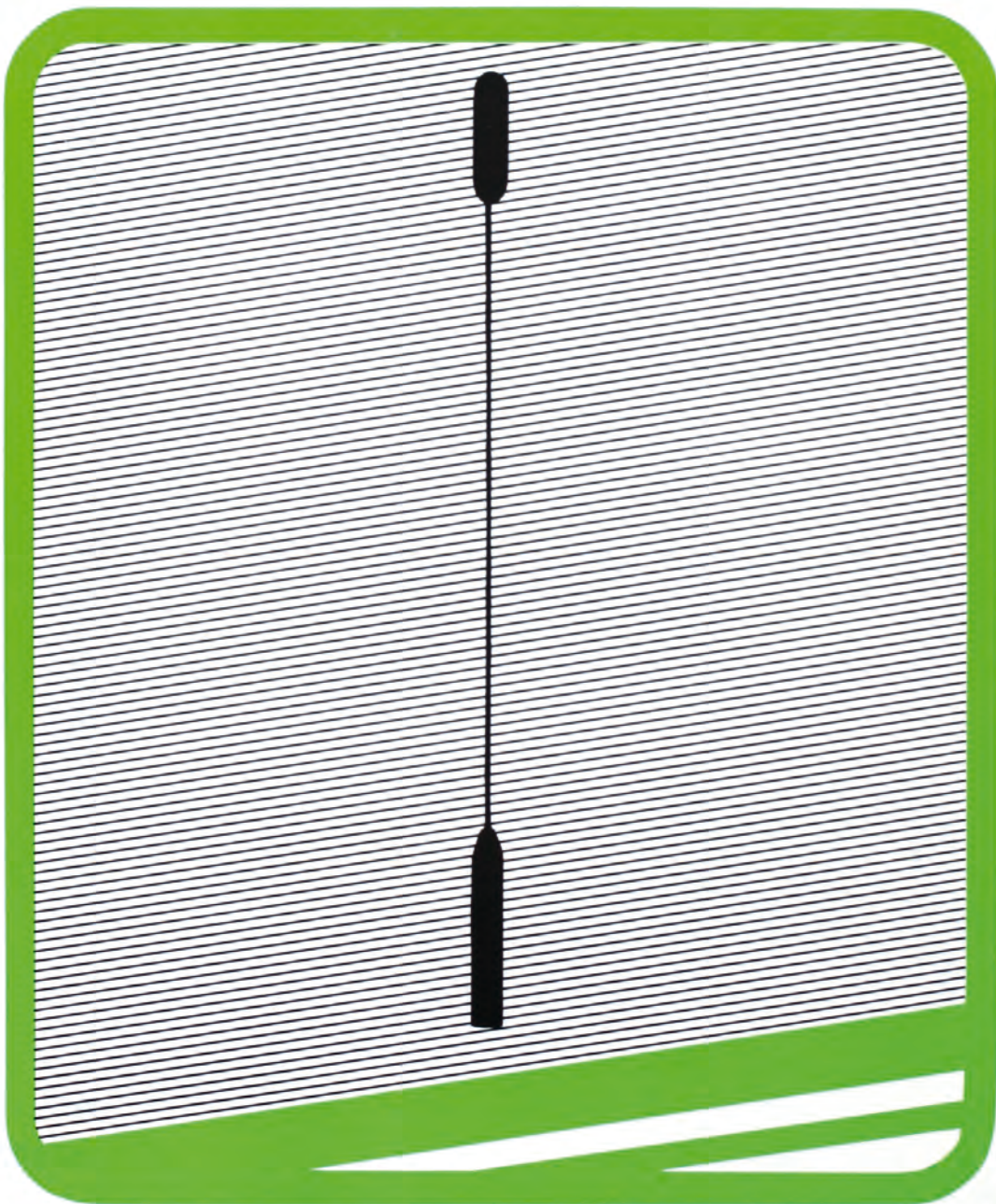

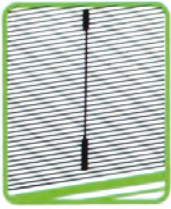

**Venenstripper-Besteck, Venenstripper  
Vein Stripper Set, Vein Strippers  
Juego para várices, Sondas para várices  
Trousse à veines, Cordes veineuses  
Astuccio per le vene, Sonde per vene**



Venenstripper-Besteck in Metalletui  
Vein stripper set in metal case  
Juego para várices en estuche de metal  
Trousse à veines en boîte métallique  
Astuccio per le vene in scatola in metallo

Ersatzteile für RU 4950-00  
Spare parts for RU 4950-00  
Piezas de repuesto  
Pièces de rechange pour RU 4950-00  
Pezzi di ricambio



sterilisierbar  
sterilizable  
esterilizable  
stérilisable  
sterilizzabile

**Nabatoff**  
135 x 100 x 25 mm  
RU 4950-00

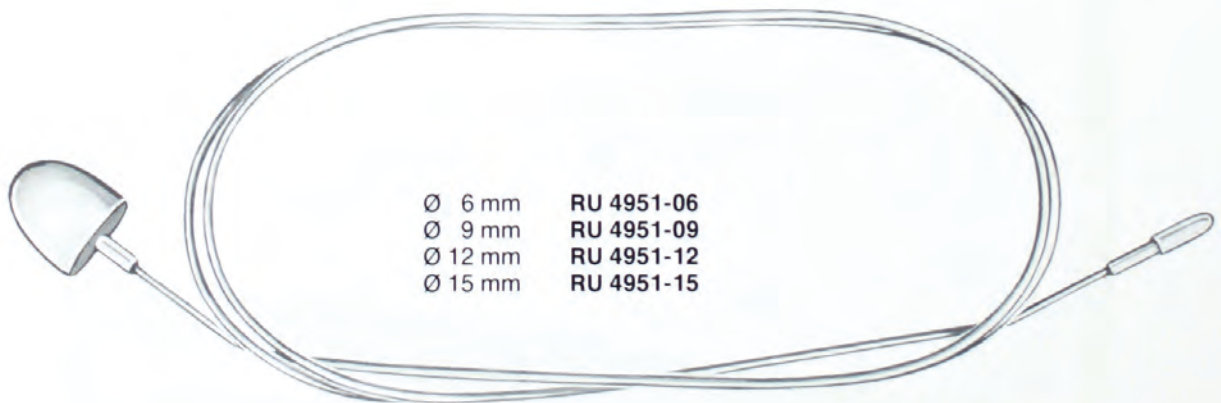
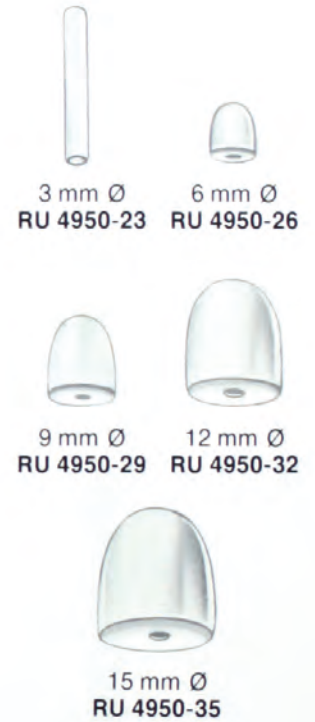

**Myers**

**Endarterektomie, Varizeninstrumente**  
**Endarterectomy, Varix Instruments**  
**Endarterectomia, Instrumental para várices**  
**Endartérectomie, Instruments pour les varices**  
**Endarterectomia, Strumenti per varici**

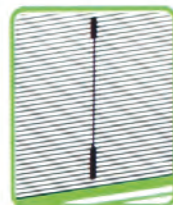

Endarterektomiestripper  
 Endarterectomy strippers  
 Sondas para endarterectomia  
 Sondes pour endartérectomie  
 Sonde per endarterectomia



55 cm/21½"

Ø  
mm

- |     |                   |                                     |
|-----|-------------------|-------------------------------------|
| 2   | <b>RU 4952-02</b> | Gefäß-Spülkanülen                   |
| 3   | <b>RU 4952-03</b> | Vessel irrigating cannulas          |
| 4   | <b>RU 4952-04</b> | Cánulas de irrigación para vasos    |
| 6   | <b>RU 4952-06</b> | Canulas d'irrigation pour vaisseaux |
| 7   | <b>RU 4952-07</b> | Canules d'irrigation pour vaisseaux |
| 8,5 | <b>RU 4952-08</b> | Canule per irrigazione per varici   |
| 10  | <b>RU 4952-10</b> |                                     |
| 12  | <b>RU 4952-12</b> |                                     |
| 14  | <b>RU 4952-14</b> |                                     |



Griff für  
 Handle for  
 Mango para  
 Manche pour  
 Manico per

RU 4952-02 – RU 4952-14

**RU 4952-00**



**Schmid**

Ø 3 mm

Ø 4 mm



**RU 4954-03**



**RU 4954-04**

Ø 5 mm

Ø 6 mm



**RU 4954-05**



**RU 4954-06**

Phlebodissektor  
 Phlebodissector  
 Disector para venas  
 Phlébo-dissecteur  
 Flebo-dissettori

Phlebextraktoren  
 Phlebextractors  
 Extractores para venas  
 Phlébo-extracteurs  
 Flebe-estrattore

Mikro-Doppelspatel  
 Micro spatula  
 Micro-espátulas  
 Micro-spatules  
 Micro-spatole doppie

Mikro-Phlebextraktor  
 Micro phlebextractor  
 Micro-extractores para venas  
 Micro-phlébo-extracteurs  
 Micro-flebo-estrattore

Mini-Phlebextraktor  
 Mini phlebextractor  
 Mini-extractores para venas  
 Mini-phlébo-extracteurs  
 Mini-flebo-estrattore



**Varady**  
 18 cm/7"  
**RU 4956-01**



**Varady**  
 18 cm/7"  
**RU 4956-02**



**Varady**  
 18 cm/7"  
**RU 4956-03**



**Varady**  
 17 cm/6¾"  
**RU 4956-04**



**Varady**  
 17 cm/6¾"  
**RU 4956-05**



**Varady**  
 17 cm/6¾"  
**RU 4956-06**

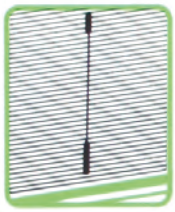

**Gefäßspatel**  
**Vessel Spatulas**  
**Espátulas vasculares**  
**Spatules pour les vaisseaux**  
**Spatole vascolari**



5 mm  
 14 cm/5½"  
**RU 4955-03/14**

7 mm  
 24 cm/9¼"  
**RU 4955-03/24**

**Schmid**



23 cm/9"  
**RU 4955-05/23**



15 cm/6"  
**RU 4955-10/15**

21 cm/8¼"  
**RU 4955-10/21**



**Davis**  
 24,5 cm/9¾"  
**RU 6342-24**

Rechtshänder  
 Right-handed  
 Para diestros  
 Pour droitier  
 Per destrimani



Set à 3 Haken  
 Set of 3 hooks  
 Set de 3 ganchos  
 Set de 3 crockets  
 Set di 3 uncini  
**RU 4956-21, -22, -23**

**RU 4956-20**

Linkshänder  
 Left-handed  
 Para zurdos  
 Pour gaucher  
 Per mancini



Set à 3 Haken  
 Set of 3 hooks  
 Set de 3 ganchos  
 Set de 3 crockets  
 Set di 3 uncini  
**RU 4956-31, -32, -33**

**RU 4956-30**



**Toennis**  
 25 cm/10"



**RU 6344-25**    **RU 6344-25/01**



**Freer**  
 18 cm/7"  
**RU 8216-18**

Gefäßspatel, Gefäßhäkchen  
 Vessel Spatula, Vessel Hooks  
 Espátulas vasculares, Ganchitos vasculares  
 Spatules et crochets pour les vaisseaux  
 Spatole ed uncini vascolari

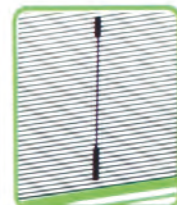

**Halle**  
 16,5 cm/6½"  
 RU 8204-16



18,5 cm/7" RU 8850-01  
 21,5 cm/8½" RU 8850-02

3 mm  
 stumpf  
 blunt  
 romos  
 mousse  
 smusso



**Crile**  
 20 cm/8"  
 RU 4425-20



**Cushing**  
 19 cm/7½"



RU 4426-01



RU 4426-02



**Krayenbühl**  
 18,5 cm/7½"  
 RU 8825-06



RU 8825-07



RU 8825-08



RU 8825-09

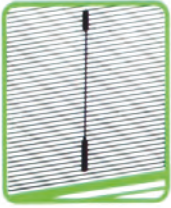

**Aorta Dilatatore, Aortenstanzen**  
**Aortic Dilators, Aortic Punches**  
**Dilatadores de aorta, Punzonadoras aorticas**  
**Dilatateurs aortiques, Emporte-pièces aortiques**  
**Dilatatori vascolari, Punzonatrice vascolari**

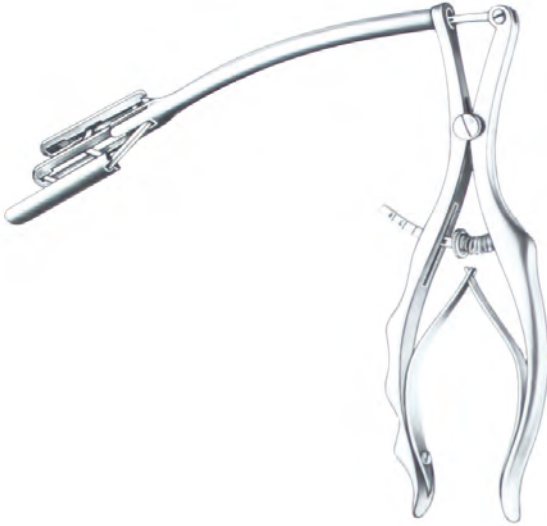

**Cooley**  
**RU 7761-00**



**Tubbs**  
**RU 7763-00**

zerlegbar  
 detachable  
 desmontable  
 démontable  
 smontabile

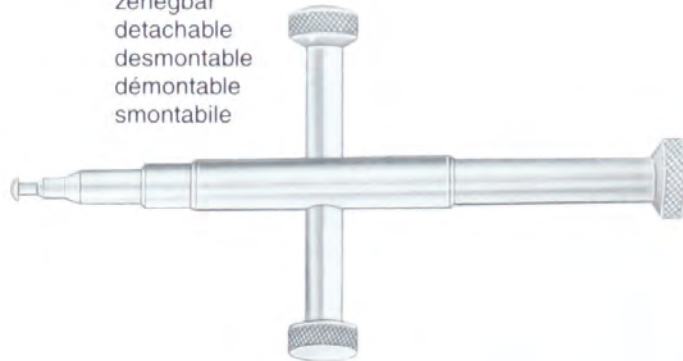

| Länge<br>length<br>largo<br>longueur<br>lunghezza | Ø mm |            |
|---|------|------------|
| 12 cm/4¾"   | 3    | RU 7765-03 |
| 12 cm/4¾"   | 4    | RU 7765-04 |
| 12 cm/4¾"   | 5    | RU 7765-05 |
| 12 cm/4¾"   | 6    | RU 7765-06 |
| 15 cm/6"  | 3    | RU 7765-13 |
| 15 cm/6"  | 4    | RU 7765-14 |
| 15 cm/6"  | 5    | RU 7765-15 |
| 15 cm/6"  | 6    | RU 7765-16 |





Embolustaßzange  
 Embolus grasping forceps  
 Pinzas para coger émbolos  
 Pince à saisir le caillot  
 Pinze per afferrare ad embolia

**Blake**  
 20 cm/8"  
 RU 6650-20



| mm Ø | 19 cm/7 1/2" | 35 cm/14"  |
|------|--------------|------------|
| 0,5  | RU 7770-05   |            |
| 1,0  | RU 7770-10   | RU 7771-10 |
| 1,5  | RU 7770-15   | RU 7771-15 |
| 2,0  | RU 7770-20   | RU 7771-20 |
| 2,5  | RU 7770-25   | RU 7771-25 |
| 3,0  | RU 7770-30   | RU 7771-30 |
| 3,5  | RU 7770-35   | RU 7771-35 |
| 4,0  | RU 7770-40   | RU 7771-40 |
| 4,5  | RU 7770-45   | RU 7771-45 |
| 5,0  | RU 7770-50   | RU 7771-50 |
| 7,0  | RU 7770-70   | RU 7771-70 |
| 9,0  | RU 7770-90   | RU 7771-90 |

**De Bakey**

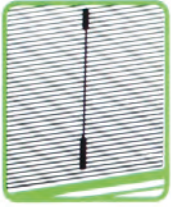

**Gefäß-Dilatatoren**  
**Vascular Dilators**  
**Dilatadores vasculares**  
**Dilatateurs vasculaires**  
**Dilatatori vascolari**



biegsam  
malleable  
maleables  
souples  
malleabili



**Garrett**

| mm Ø | 14 cm/5½"         | 21 cm/8¼"         |
|------|-------------------|-------------------|
| 1,0  | <b>RU 7773-00</b> | <b>RU 7773-18</b> |
| 1,5  | <b>RU 7773-02</b> | <b>RU 7773-20</b> |
| 2,0  | <b>RU 7773-04</b> | <b>RU 7773-22</b> |
| 2,5  | <b>RU 7773-06</b> | <b>RU 7773-24</b> |
| 3,0  | <b>RU 7773-08</b> | <b>RU 7773-26</b> |
| 3,5  | <b>RU 7773-10</b> | <b>RU 7773-28</b> |
| 4,0  | <b>RU 7773-12</b> | <b>RU 7773-30</b> |
| 4,5  | <b>RU 7773-14</b> | <b>RU 7773-32</b> |
| 5,0  | <b>RU 7773-16</b> | <b>RU 7773-34</b> |
| Satz | <b>RU 7773-36</b> | <b>RU 7773-38</b> |

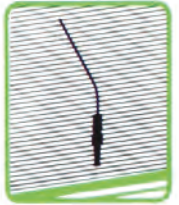

RU 5260-01 ▶

**Yankauer**  
 27 cm/10<sup>1</sup>/<sub>2</sub>"  
 RU 5260-27



Ø 9 mm

mit zentraler Bohrung, Ø 3,0 mm  
 und seitlichen Schlitzten  
 with central bore, 3.0 mm diam. and  
 lateral slots  
 con perforación central Ø 3,0 mm  
 y hendidura lateral  
 avec perçage central Ø 3,0 mm  
 et taillades latérales  
 con perforazione centrale Ø 3,0 mm  
 scanalatura laterale

Olive  
 Ø 6 – 10 mm

**DeBakey**  
 27,5 cm/10<sup>1</sup>/<sub>2</sub>"  
 RU 5267-01

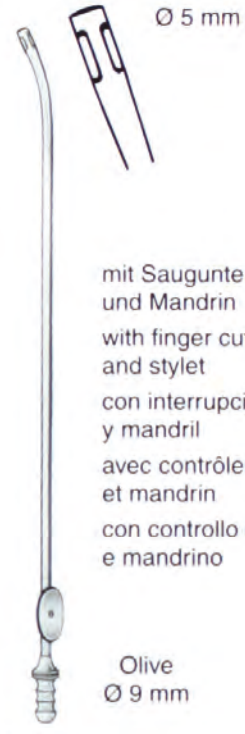

Ø 5 mm

mit Saugunterbrecher  
 und Mandrin  
 with finger cut-off  
 and stylet  
 con interrupción de succión  
 y mandril  
 avec contrôle d'aspiration  
 et mandrin  
 con controllo di aspirazione  
 e mandrino

Olive  
 Ø 9 mm

**DeBakey**  
 16 cm/ 6<sup>1</sup>/<sub>4</sub>" **RU 5268-16**  
 27 cm/10<sup>3</sup>/<sub>4</sub>" **RU 5268-27**



mm Ø  
 2  
 2<sup>1</sup>/<sub>3</sub>  
 2<sup>2</sup>/<sub>3</sub>  
 3  
 3<sup>1</sup>/<sub>3</sub>  
 3<sup>2</sup>/<sub>3</sub>  
 4  
 5

**Frazier**  
 Charr./Fr.  
 6 **RU 6420-06**  
 7 **RU 6420-07**  
 8 **RU 6420-08**  
 9 **RU 6420-09**  
 10 **RU 6420-10**  
 11 **RU 6420-11**  
 12 **RU 6420-12**  
 15 **RU 6420-15**



Ø 4 mm

**Fergusson**  
 Charr./Fr.  
 6 **RU 6421-06**  
 7 **RU 6421-07**  
 8 **RU 6421-08**  
 9 **RU 6421-09**  
 10 **RU 6421-10**  
 11 **RU 6421-11**  
 12 **RU 6421-12**

isoliert, mit Saugunterbrecher und Mandrin,  
 Griffplatte 90° zur Biegung, LUER-Bohrung  
 insulated, with finger cut-off and stylet,  
 thumb piece 90° to curve, with LUER hub  
 aislada con interrupción de succión  
 y mandril, pieza 90° de curvatura, perforación LUER  
 isolée, avec contrôle d'aspiration et mandrin,  
 touche 90° à la courbure, perçage LUER  
 isolato, con controllo di aspirazione, tasto 90° sulla curva,  
 con mandrino perforazione LUER

Olive  
 Ø 6 – 9 mm  
**Fergusson**  
 18 cm/7<sup>1</sup>/<sub>2</sub>"  
**RU 6421-34**

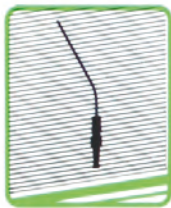

Saugrohre, Tourniquets  
Suction Tubes, Tourniquets  
Cánulas de aspiración, Torniquetes  
Canules d'aspiration, Tourniquets  
Tubi d'aspirazione, Tornichetti

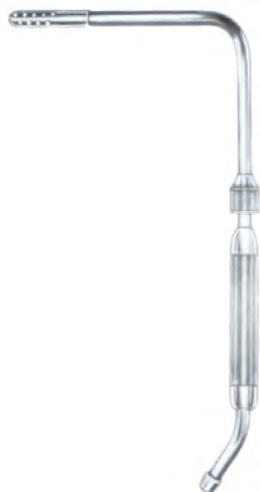

**Cooley**  
25 cm/10"  
RU 7780-01



**Cooley**  
33 cm/13"  
RU 7780-02



**Cooley**  
30 cm/12"  
RU 7780-03



**Cooley**  
30 cm/12"  
RU 7780-04



**Cooley**  
35 cm/13<sup>3</sup>/<sub>4</sub>"  
RU 7780-05

Tourniquets  
Tourniquets  
Torniquetes  
Tourniquets  
Tornichetti



**Rumel-Belmont**  
3,2 mm Ø    RU 7787-32  
6,4 mm Ø    RU 7787-64

Knocheninstrumente  
Bone Instruments  
Instrumental óseo  
Instruments à os  
Strumenti ossea

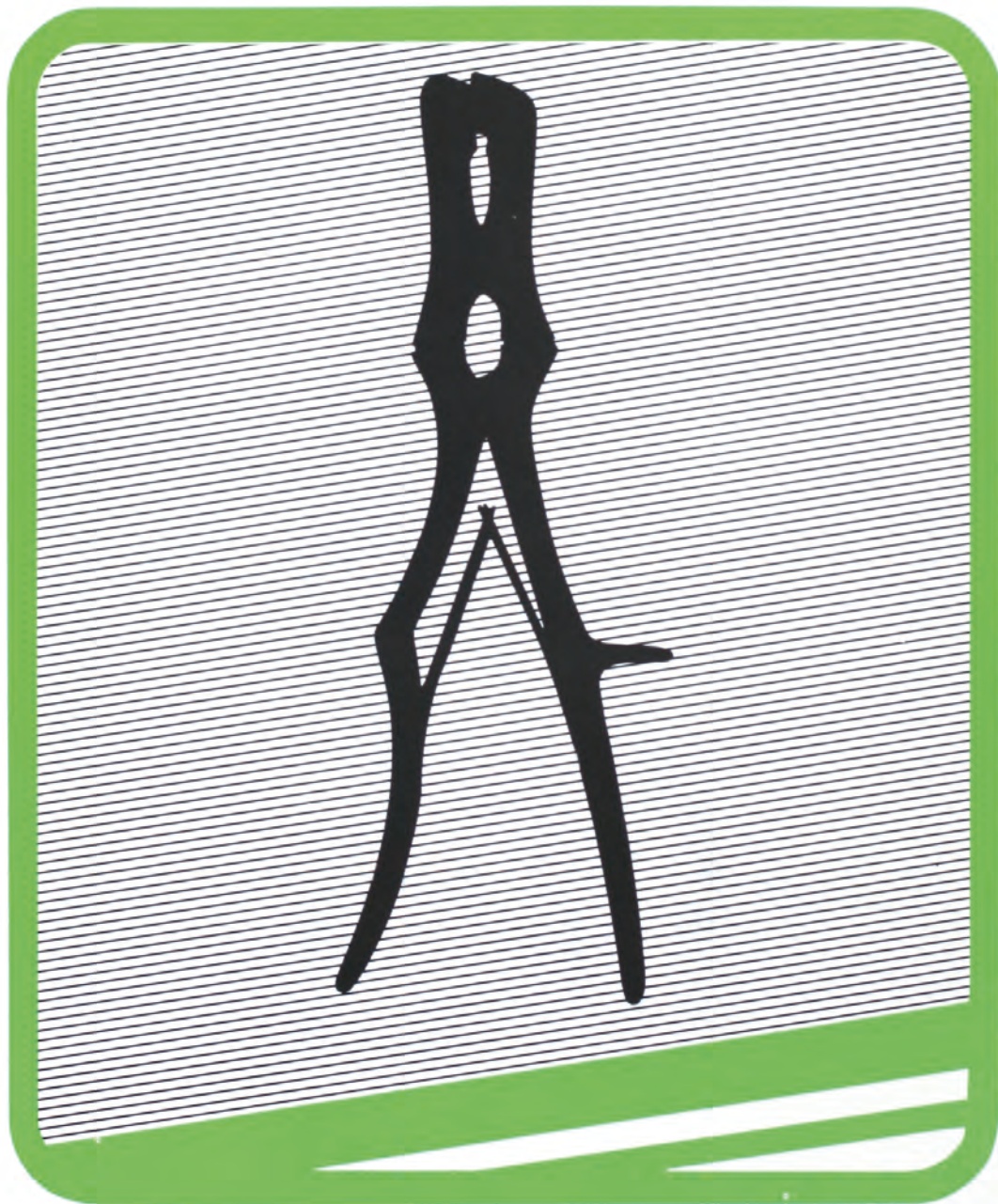



Raspatorien  
Periosteal Raspatories  
Legras – Periostótomos  
Rugines à périostomie  
Periostotomi



**Langenbeck**  
19 cm/7½"  
RU 5383-19



**Langenbeck**  
18 cm/7"  
RU 5384-18



**Lambotte**  
21 cm/8¼"

breit  
width  
ancho  
largeur  
larghezza

mm

|    |            |
|----|------------|
| 5  | RU 5385-05 |
| 10 | RU 5385-10 |
| 15 | RU 5385-15 |
| 20 | RU 5385-20 |
| 25 | RU 5385-25 |



**Alexander**  
20 cm/8"  
RU 5387-20



**Davidson-Alexander**  
29 cm/11½"  
RU 5389-29



**Matson**  
22 cm/8¾"  
RU 5397-22

**Raspatorien**  
**Periosteal Raspatories**  
**Legras – Periostótomos**  
**Rugines à périostomie**  
**Periostotomi**



**Semb**

|  |                   |                   |                   |                   |                   |                   |                   |
|--|-------------------|-------------------|-------------------|-------------------|-------------------|-------------------|-------------------|
|  | 12 mm             | 12 mm             | 12 mm             | 13 mm             | 13 mm             | 15 mm             | 15 mm             |
|  |                   |                   |                   |                   |                   |                   |                   |
|  | 17,5 cm/7"        | 21 cm/8¼"         | 17,5 cm/7"        | 20 cm/8"          | 22 cm/8¾"         | 20,5 cm/8"        | 20,5 cm/8"        |
|  | <b>RU 5398-01</b> | <b>RU 5398-02</b> | <b>RU 5398-03</b> | <b>RU 5398-04</b> | <b>RU 5398-05</b> | <b>RU 5398-06</b> | <b>RU 5398-07</b> |



**Doyen**  
17 cm/6¾"

|  |                   |
|--|-------------------|
|  |                   |
| <b>RU 5400-01</b>  | <b>RU 5400-02</b> |
| für Erwachsene<br>for adults<br>para adultos<br>pour des adultes<br>per adulti |                   |
|  |                   |
| <b>RU 5402-01</b>  | <b>RU 5402-02</b> |
| für Kinder<br>for children<br>para niños<br>pour des enfants<br>per bambini    |                   |



**Doyen**  
24 cm/9½"  
**RU 5401-01** **RU 5401-02**



Knochenhalte­zangen  
Bone Holding Forceps  
Pinzas para huesos  
Daviers porte-os  
Tenaglie per ossa



12 mm

**Langenbeck**  
21 cm/8<sup>1</sup>/<sub>4</sub>"  
RU 5514-21



11 mm

**Fergusson**  
21 cm/8<sup>1</sup>/<sub>4</sub>"  
RU 5516-21



8 mm

**Semb**  
19 cm/7<sup>1</sup>/<sub>2</sub>"  
RU 5525-19



7,5 mm

**Semb**  
19 cm/7<sup>1</sup>/<sub>2</sub>"  
RU 5525-51



**Hohlmeißelzangen**  
**Bone Rongeur Forceps**  
**Pinzas - gubias**  
**Pinces - gouges**  
**Pinze - sgorbie**

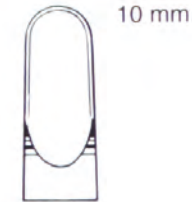
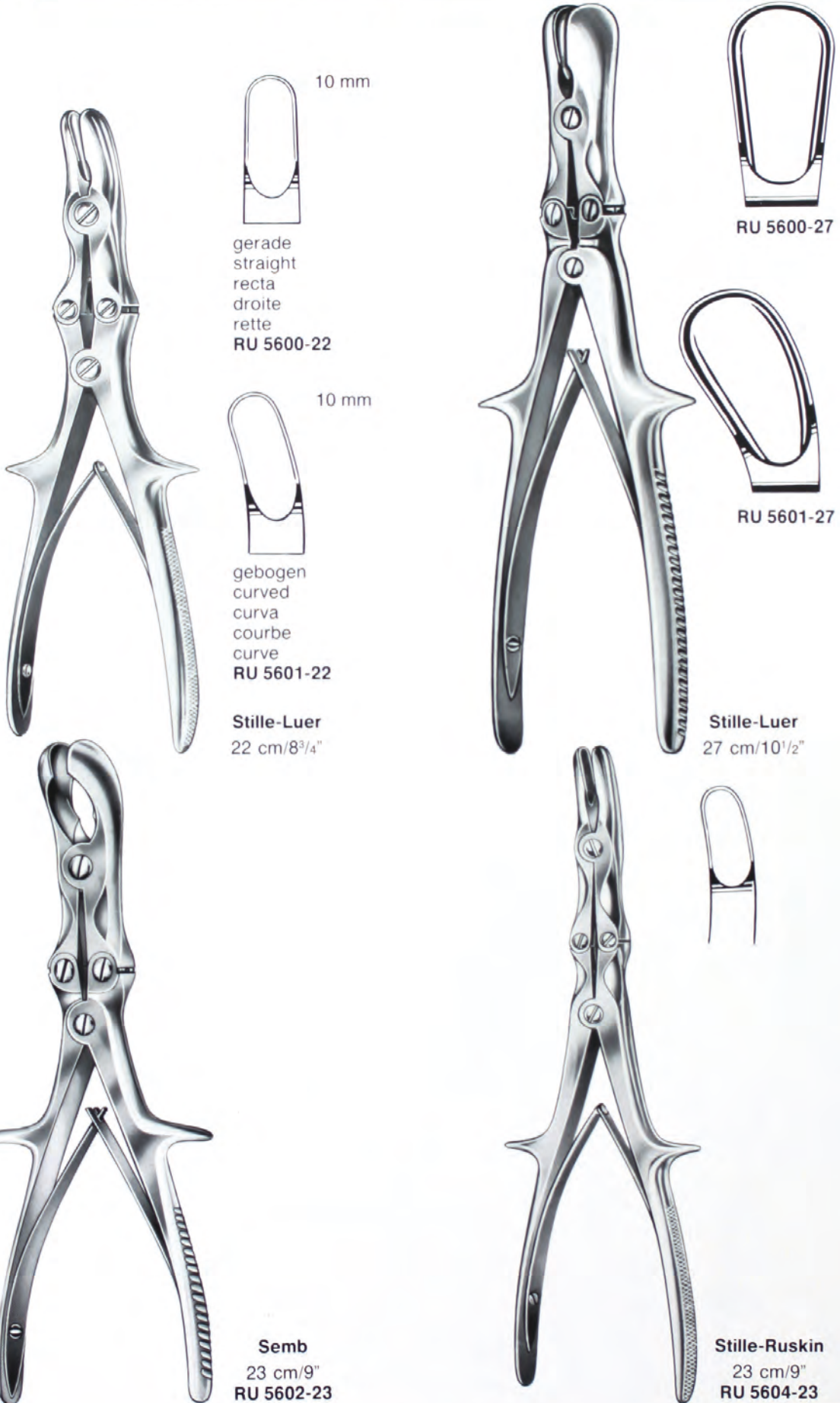

gerade  
straight  
recta  
droite  
rette  
**RU 5600-22**



gebogen  
curved  
curva  
courbe  
curve  
**RU 5601-22**



**RU 5600-27**



**RU 5601-27**

**Stille-Luer**  
22 cm/8<sup>3</sup>/<sub>4</sub>"

**Stille-Luer**  
27 cm/10<sup>1</sup>/<sub>2</sub>"

**Semb**  
23 cm/9"  
**RU 5602-23**

**Stille-Ruskin**  
23 cm/9"  
**RU 5604-23**



Hohlmeißelzangen  
 Bone Rongeur Forceps  
 Pinzas – gubias  
 Pincers – gouges  
 Pinze – sgorbie

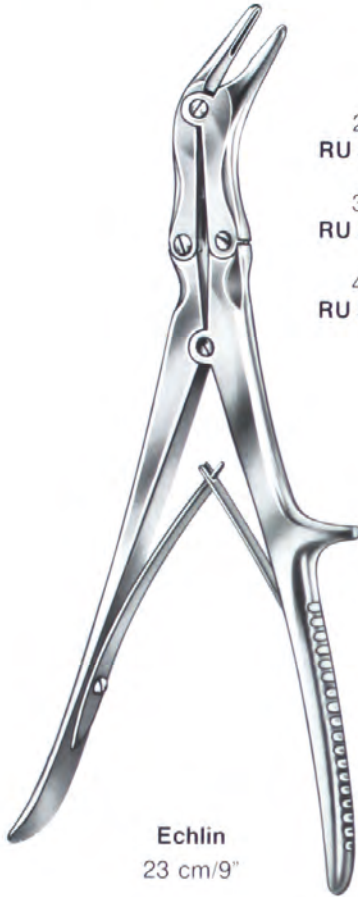

2 mm  
 RU 5605-02  
 3 mm  
 RU 5605-03  
 4 mm  
 RU 5605-04

**Echlin**  
 23 cm/9"



3 mm  
 RU 5606-03  
 4 mm  
 RU 5606-04  
 6 mm  
 RU 5606-06  
 8 mm  
 RU 5606-08

**Leksell**  
 25 cm/10"



**Frykholm**  
 23 cm/9"  
 RU 5607-23



**Stille**  
 23 cm/9"  
 RU 5608-23



**Sauerbruch**  
 30 cm/12"

RU 5611-29  
 RU 5610-29



**Dale**  
 34 cm/13½"  
 RU 5616-34

**Knochensplitterzangen**  
**Bone Cutting Forceps**  
**Pinzas cortantes para huesos**  
**Pinces coupantes à os**  
**Pinze cesoie per ossa**



**Markwalder**  
 20 cm/8"  
 RU 5635-20



gerade  
 straight  
 rectas  
 droites  
 rette

|            | cm | in    |
|------------|----|-------|
| RU 5640-14 | 14 | 5 1/2 |
| RU 5640-17 | 17 | 6 3/4 |
| RU 5640-19 | 19 | 7 1/2 |
| RU 5640-22 | 22 | 8 3/4 |



gebogen  
 curved  
 curvas  
 courbes  
 curve

|            |
|------------|
| RU 5641-14 |
| RU 5641-17 |
| RU 5641-19 |
| RU 5641-22 |



**Cleveland**

|              |            |
|--------------|------------|
| 13 cm/5"     | RU 5648-13 |
| 15 cm/6"     | RU 5643-15 |
| 17 cm/6 3/4" | RU 5648-17 |



**Böhler**

15 cm/6"



gerade  
 straight  
 recta  
 droite  
 rette

RU 5700-15



aufgebogen  
 curved on flat  
 curva  
 courbe vers le haut  
 curve verso l'alto

RU 5701-15



**Mc Indoe**

17,5 cm/7"  
 RU 5702-17



**Knochensplitterzangen**  
**Bone Cutting Forceps**  
**Pinzas cortantes para huesos**  
**Pinces coupantes à os**  
**Pinze cesoie per ossa**



gerade  
straight  
recta  
droite  
retta  
**RU 5710-18**

aufgebogen  
curved on flat  
curva sobre el plano  
courbe vers le haut  
curva verso l'alto  
**RU 5711-18**

**Ruskin-Liston**  
18,5 cm/7<sup>1</sup>/<sub>4</sub>"

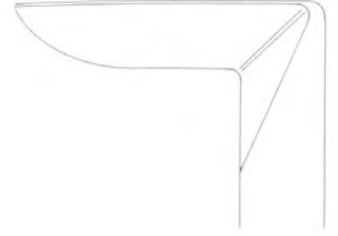

27 cm/10<sup>1</sup>/<sub>2</sub>"  
**RU 5715-27**

**Stille-Liston**

|  |                   |                   |
|--|-------------------|-------------------|
| 23 cm/9"                               | <b>RU 5716-23</b> | <b>RU 5717-23</b> |
| 27 cm/10 <sup>1</sup> / <sub>2</sub> " | <b>RU 5716-27</b> | <b>RU 5717-27</b> |



**Liston-Key (Horsley)**  
27 cm/10<sup>1</sup>/<sub>2</sub>"  
**RU 5718-27**



**Semb**  
24 cm/9<sup>1</sup>/<sub>2</sub>"  
**RU 5719-25**

Drahtinstrumente  
Wire Instruments  
Instrumental para alambre  
Instruments à fils  
Strumenti per fili

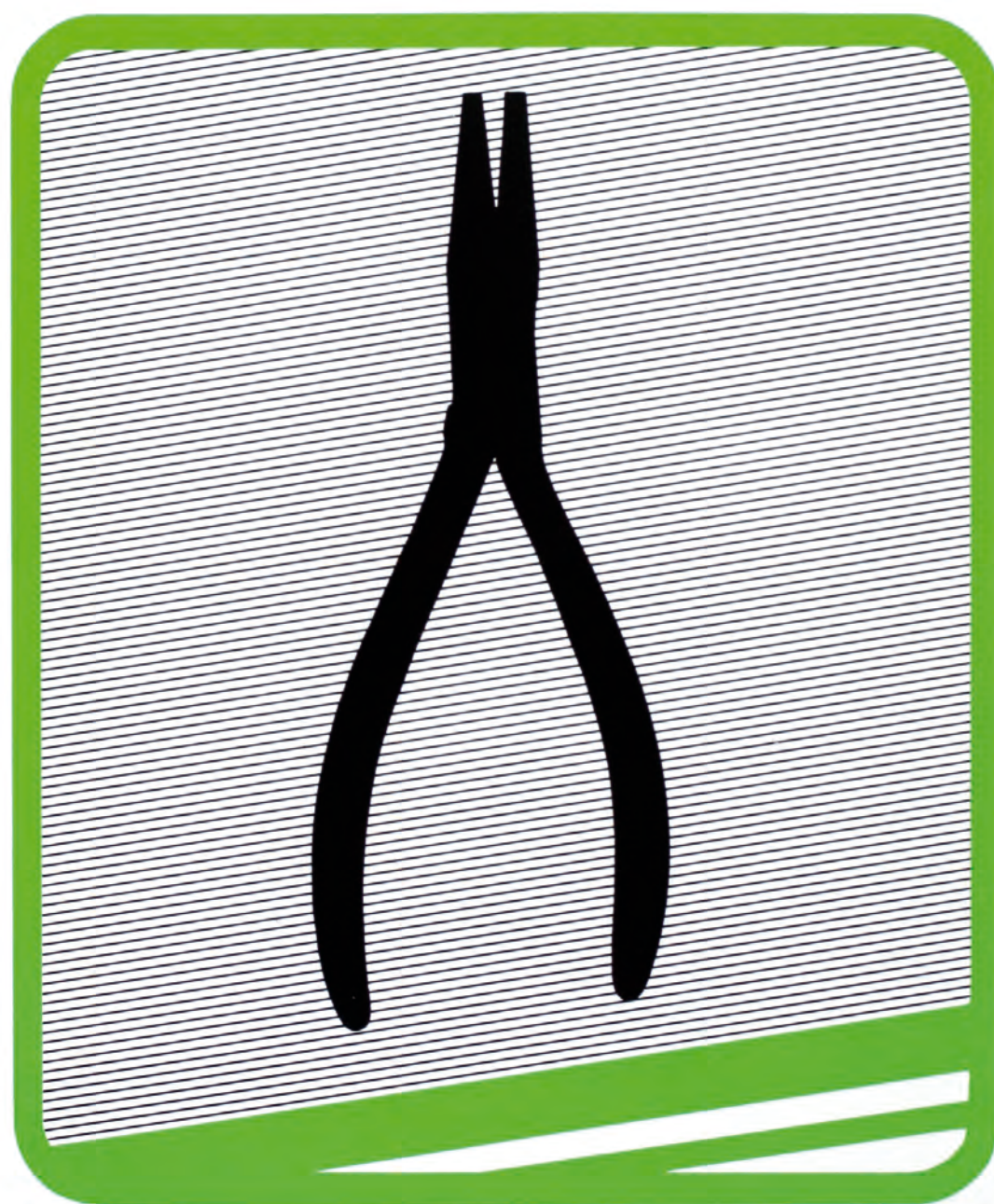



**Drahtscheren, Knochendraht, Drahtzangen**  
**Wire Cutting Scissors, Bone Wire, Wire Cutting Pliers**  
**Cizallas para cortar alambre, Hilos para huesos, Alicates para cortar alambre**  
**Coupe-fils, Fil à os, Pincès à fils**  
**Forbici per fili metallici, Filo per ossa, Pinze per fili**



**Rudolf**  
TC



gezahnt  
saw edge  
dentadas  
dentelés  
dentellate

**Universal**  
12 cm/4¾"  
RU 2600-12



**Universal**  
12 cm/4¾"  
RU 2601-12



gezahnt  
saw edge  
dentadas  
dentelés  
dentellate

**Harvey**  
12,5 cm/5"  
RU 2610-12



Knochendraht, in Ringen zu 10 m  
 Bone wire, 10 m  
 Hilos para huesos, 10 m  
 Fil à os, 10 m  
 Filo per ossa, 10 m

|      |            |
|------|------------|
|      | weich      |
|      | soft       |
|      | blando     |
|      | mous       |
|      | morbidi    |
| mm Ø |            |
| 0,2  | RU 5778-02 |
| 0,3  | RU 5778-03 |
| 0,4  | RU 5778-04 |
| 0,5  | RU 5778-05 |
| 0,6  | RU 5778-06 |
| 0,7  | RU 5778-07 |
| 0,8  | RU 5778-08 |
| 0,9  | RU 5778-09 |
| 1,0  | RU 5778-10 |
| 1,2  | RU 5778-12 |
| 1,5  | RU 5778-15 |



14 cm/5½"  
RU 5760-14



0,5 **Rudolf**  
TC

RU 5761-00/18 18 cm/7"  
 RU 5761-00/20 20 cm/8"

Drahtzangen  
 Wire Cutting Pliers  
 Alicates para cortar alambre  
 Pinces à fils  
 Pinze per fili



**Rudolf**  
 TC

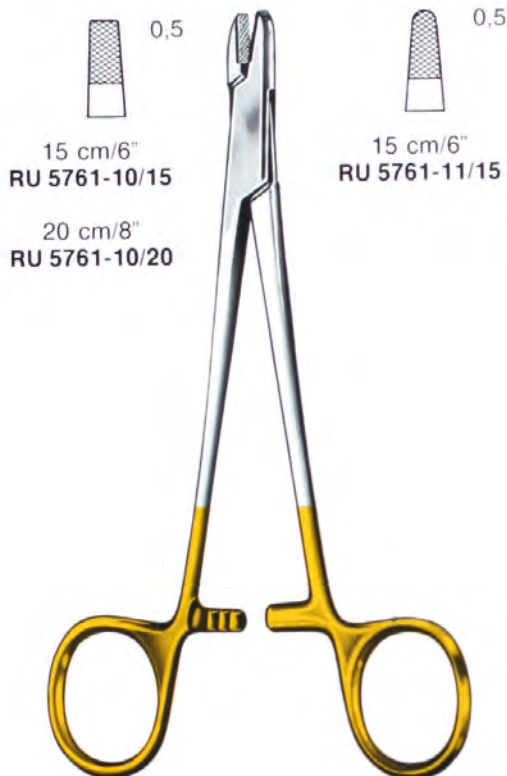

**Rudolf**  
 TC

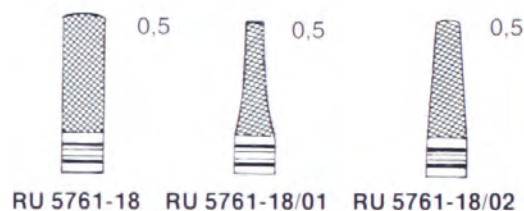

**Rudolf**  
 TC





**Drahtkneifzangen, Kopf- und Seitenschneider**

**Wire Cutting Pliers, Lateral and Frontal Cutting Pliers**

**Alicates para cortar alambre, Alicates para alambre con corte lateral y frontal**

**Pinces à couper le fil, Pinces coupe-fils coupant latéral et frontal**

**Tronchese tagliafili, Tenaglie tagliafili, Tronchese taglio laterali**



**Rudolf**  
TC

für weichen  
Draht bis Ø  
for soft wire  
with a diam. of max.  
para hilos blandos  
de un diámetro  
maximo de  
pour fils mous avec  
un diamètre jusqu'à  
per fili morbidi  
di diametro fino a



12 cm/4<sup>3</sup>/<sub>4</sub>"  
RU 5766-12  
0,7 mm



18 cm/7"  
RU 5767-18  
2,0 mm

für harten  
Draht bis Ø  
for hard wire  
with a diam. of max.  
para hilos duros  
de un diámetro maximo de  
pour fils durs avec  
un diamètre jusqu'à  
per fili duri di  
diametro fino a

0,5 mm

1,7 mm



Nadelhalter  
Needle Holders  
Porta-agujas  
Porte-aiguilles  
Portaghi

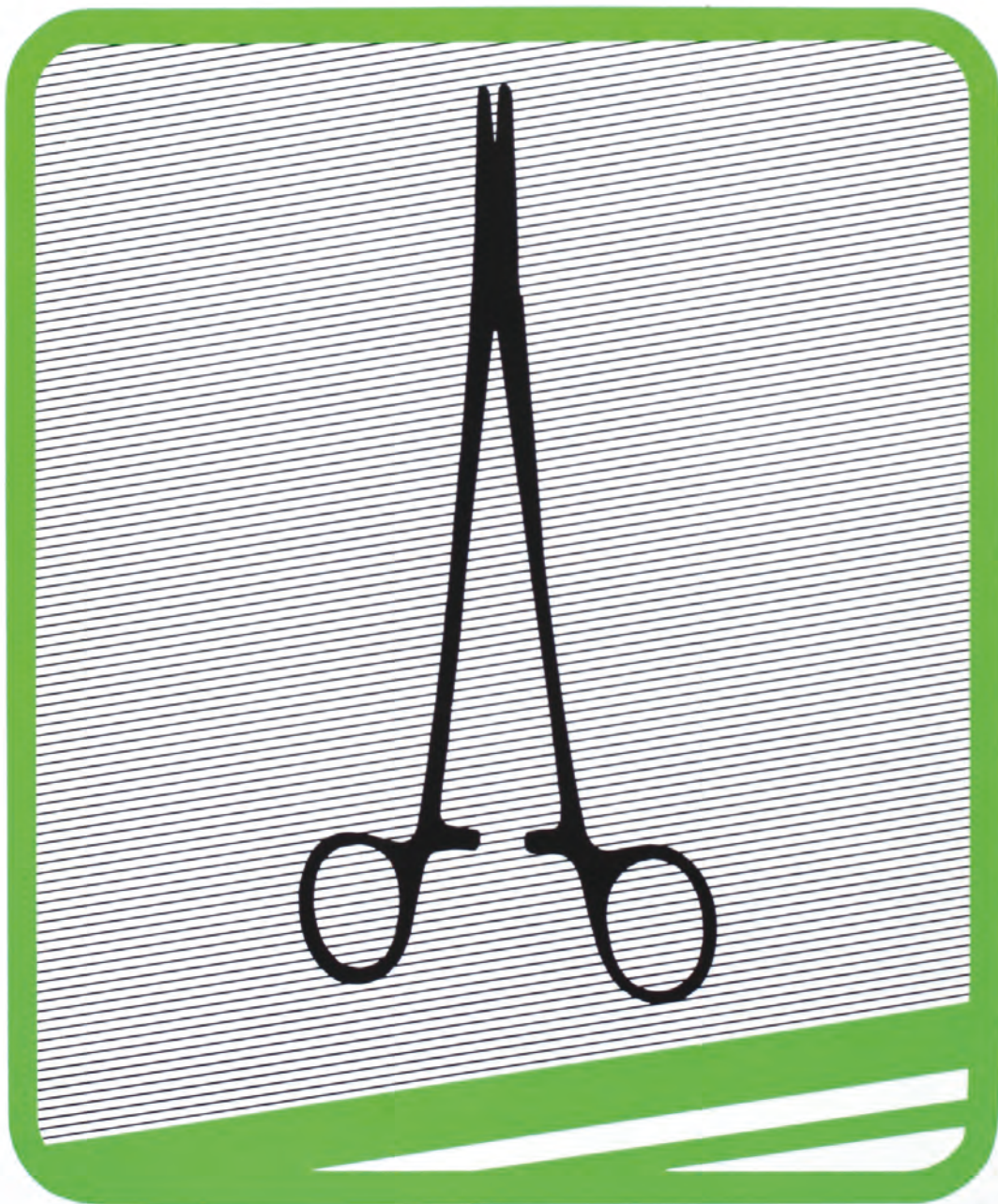



**Mikro-Grip Nadelhalter**  
**Micro-Grip Needle Holders**  
**Micro-Grip Porta-agujas**  
**Porte-aiguilles Micro-Grip**  
**Micro-Grip portaghi**



**rudolf**  
**MIKRO-GRIP**



**Castroviejo**  
 14 cm/5½"

**Jacobson**  
 18 cm/7", 21 cm/8¼"

mit Sperre  
 with ratchet  
 con cremallera  
 avec crémaillère  
 con cremagliera



gerade  
 straight  
 rectas  
 droites  
 rette



gebogen  
 curved  
 curvas  
 courbes  
 curve

|           |                      |                      |
|-----------|----------------------|----------------------|
| 14 cm/5½" | RU 5846-02           | RU 5846-03           |
|           | RU 5846-52           | RU 5846-53           |
| 18 cm/7"  | <b>RU 5846-52 TI</b> | <b>RU 5846-53 TI</b> |
|           | RU 5846-62           | RU 5846-63           |
| 21 cm/8¼" | <b>RU 5846-62 TI</b> | <b>RU 5846-63 TI</b> |

ohne Sperre  
 without ratchet  
 sin cremallera  
 sans crémaillère  
 senza cremagliera

|           |                      |                      |
|-----------|----------------------|----------------------|
| 14 cm/5½" | RU 5846-04           | RU 5846-05           |
|           | RU 5846-54           | RU 5846-55           |
| 18 cm/7"  | <b>RU 5846-54 TI</b> | <b>RU 5846-55 TI</b> |
|           | RU 5846-64           | RU 5846-65           |
| 21 cm/8¼" | <b>RU 5846-64 TI</b> | <b>RU 5846-65 TI</b> |

**rudolf**  
**MIKRO-GRIP**



**Castroviejo**  
 14 cm/5½"

**Jacobson**  
 18 cm/7" - 23 cm/9"

mit Sperre  
 with ratchet  
 con cremallera  
 avec crémaillère  
 con cremagliera



gerade  
 straight  
 rectas  
 droits  
 rette



gebogen  
 curved  
 curvas  
 courbes  
 curve

|           |                         |                         |
|-----------|-------------------------|-------------------------|
| 14 cm/5½" | RU 5846-14/00           | RU 5846-14/01           |
|           | RU 5846-18/00           | RU 5846-18/01           |
| 18 cm/7"  | <b>RU 5846-18/00 TI</b> | <b>RU 5846-18/01 TI</b> |
|           | RU 5846-21/00           | RU 5846-21/01           |
| 21 cm/8¼" | <b>RU 5846-21/00 TI</b> | <b>RU 5846-21/01 TI</b> |
|           | RU 5846-23/00           | RU 5846-23/01           |
| 23 cm/9"  | <b>RU 5846-23/00 TI</b> | <b>RU 5846-23/01 TI</b> |

ohne Sperre  
 without ratchet  
 sin cremallera  
 sans crémaillère  
 senza cremagliera

|           |                         |                         |
|-----------|-------------------------|-------------------------|
| 14 cm/5½" | RU 5846-14/02           | RU 5846-14/03           |
|           | RU 5846-18/02           | RU 5846-18/03           |
| 18 cm/7"  | <b>RU 5846-18/02 TI</b> | <b>RU 5846-18/03 TI</b> |
|           | RU 5846-21/02           | RU 5846-21/03           |
| 21 cm/8¼" | <b>RU 5846-21/02 TI</b> | <b>RU 5846-21/03 TI</b> |
|           | RU 5846-23/02           | RU 5846-23/03           |
| 23 cm/9"  | <b>RU 5846-23/02 TI</b> | <b>RU 5846-23/03 TI</b> |

TI = TITAN



**Rudolf**  
 MIKRO-GRIP

**Rudolf**  
 TITAN



15 cm/6"  
 17 cm/6¾"  
 19 cm/7½"

**RU 5847-01 TI**  
**RU 5847-02 TI**  
**RU 5847-03 TI**

Ryder



18 cm/7"  
 20 cm/8"  
 22 cm/8¾"  
 25 cm/10"

**RU 5847-11 TI**  
**RU 5847-12 TI**  
**RU 5847-13 TI**  
**RU 5847-14 TI**

De Bakey



16 cm/6¼"  
 18 cm/7"  
 20 cm/8"  
 22 cm/8¾"  
 25 cm/10"

**RU 5847-21 TI**  
**RU 5847-22 TI**  
**RU 5847-23 TI**  
**RU 5847-24 TI**  
**RU 5847-25 TI**

Microvascular



**Mikro-Nadelhalter  
Micro Needle Holders  
Micro-porta-agujas  
Micro-porte-aiguilles  
Micro-portaghi**



Yasargil

Yasargil

|   |                   |                   |                   |                   |                   |
|---|-------------------|-------------------|-------------------|-------------------|-------------------|
| 15 cm/6"                                | <b>RU 5850-15</b> | <b>RU 5851-15</b> |                   |                   |                   |
| 18 cm/7"                                | <b>RU 5850-18</b> | <b>RU 5851-18</b> | <b>RU 5852-18</b> | <b>RU 5856-18</b> | <b>RU 5857-18</b> |
| 22,5 cm/8 <sup>3</sup> / <sub>4</sub> " |                   |                   |                   | <b>RU 5856-23</b> | <b>RU 5857-23</b> |



gerade  
straight  
rectas  
droites  
rette



gebogen  
curved  
curvas  
courbes  
curve



abgewinkelt  
angled  
acodadas  
coudées  
angolate

mit Sperre  
with ratchet  
con cremallera  
avec crémaillère  
con cremagliera

mit Sperre  
with ratchet  
con cremallera  
avec crémaillère  
con cremagliera

mit Sperre  
with ratchet  
con cremallera  
avec crémaillère  
con cremagliera

|   |                   |                   |                   |                   |                   |                   |
|---|-------------------|-------------------|-------------------|-------------------|-------------------|-------------------|
| 12 cm/4 <sup>3</sup> / <sub>4</sub> "   | <b>RU 5860-12</b> | <b>RU 5864-12</b> | <b>RU 5861-12</b> | <b>RU 5865-12</b> | <b>RU 5863-12</b> | <b>RU 5867-12</b> |
| 15 cm/6"                                | <b>RU 5860-15</b> | <b>RU 5864-15</b> | <b>RU 5861-15</b> | <b>RU 5865-15</b> |                   |                   |
| 18,5 cm/7 <sup>1</sup> / <sub>4</sub> " | <b>RU 5860-18</b> | <b>RU 5864-18</b> | <b>RU 5861-18</b> | <b>RU 5865-18</b> |                   |                   |
| 23 cm/9"                                | <b>RU 5860-23</b> |                   | <b>RU 5861-23</b> |                   |                   |                   |

**Mikro-Nadelhalter, Nadelhalter mit Hartmetalleinlagen**  
**Micro Needle Holders, Needle Holders with Tungsten Carbide Inserts**  
**Micro-porta-agujas, Porta-agujas con placas de carburo tungsteno**  
**Micro-porte-aiguilles, Porte-aiguilles avec mors en carbure de tungstène**  
**Micro-portaghi, Portaghi con placche di carburo di tungsteno**



gerade  
straight  
rectas  
droites  
rette

15 cm/6"  
18,5 cm/7¼"  
21 cm/8¼"

gebogen  
curved  
curvas  
courbes  
curve

15 cm/6"  
18,5 cm/7¼"  
21 cm/8¼"

**Rudolf**  
**TITAN**



0,4 mm

**RU 5860-15/04 TI**  
**RU 5860-18/04 TI**  
**RU 5860-21/04 TI**



0,8 mm

**RU 5860-15/08 TI**  
**RU 5860-18/08 TI**  
**RU 5860-21/08 TI**



0,4 mm

**RU 5861-15/04 TI**  
**RU 5861-18/04 TI**  
**RU 5861-21/04 TI**



0,8 mm

**RU 5861-15/08 TI**  
**RU 5861-18/08 TI**  
**RU 5861-21/08 TI**

**Rudolf**  
**TC**



**Bozemann**



0,5

20 cm/8"  
**RU 6049-20**



0,5

24 cm/9½"  
**RU 6049-24**



0,5

26 cm/10½"  
**RU 6049-26**



**Mayo-Hegar**



0,5

16 cm/6¼"  
**RU 6050-16**  
**RU 6050-16 TI**



0,5

18 cm/7"  
**RU 6050-18**  
**RU 6050-18 TI**



0,5

20 cm/8"  
**RU 6050-20**  
**RU 6050-20 TI**



0,5

24 cm/9½"  
**RU 6050-24**



0,5

26 cm/10½"  
**RU 6050-26**



0,5

30 cm/12"  
**RU 6050-30**



**Nadelhalter mit Hartmetalleinlagen**  
**Needle Holders with Tungsten Carbide Inserts**  
**Porta-agujas con placas de carburo tungsteno**  
**Porte-aiguilles avec mors en carbure de tungstène**  
**Portaghi con placche di carburo di tungsteno**



**Rudolf**  
TC



Mayo-Hegar

0,5  
20 cm/8"  
RU 6051-20

0,5  
24 cm/9½"  
RU 6051-24

0,5  
26 cm/10½"  
RU 6051-26



Mayo-Hegar

0,5  
20 cm/8"  
RU 6053-20

0,5  
24 cm/9½"  
RU 6053-24

schweres Modell  
heavy pattern  
modelo robusto  
modelò robuste  
modello robusto



De Bakey

0,3  
18 cm/7"  
RU 6054-18  
RU 6054-18 TI

0,3  
20 cm/8"  
RU 6054-20  
RU 6054-20 TI

0,3  
23 cm/9"  
RU 6054-23  
RU 6054-23 TI

0,3  
26 cm/10¼"  
RU 6054-26  
RU 6054-26 TI

0,3  
31 cm/12¼"  
RU 6054-31



De Bakey-Fine

0,3  
18 cm/7"  
RU 6054-68

0,3  
20 cm/8"  
RU 6054-70

0,3  
23 cm/9"  
RU 6054-73

0,3  
26 cm/10¼"  
RU 6054-76

0,3  
31 cm/12¼"  
RU 6054-81

TI = TITAN

**Nadelhalter mit Hartmetalleinlagen**  
**Needle Holders with Tungsten Carbide Inserts**  
**Porta-agujas con placas de carburo tungsteno**  
**Porte-aiguilles avec mors en carbure de tungstène**  
**Portaghi con placche di carburo di tungsteno**



**Rudolf**  
TC



0,4  
19,5 cm/7¾"  
RU 6054-89

0,4  
24,5 cm/9¾"  
RU 6054-94

De Bakey



0,3  
15 cm/6"  
RU 6055-01

Baby-Crile-Wood



0,4  
15 cm/6"  
RU 6055-15/1

glatt  
smooth  
lisa  
lisse  
liscie  
15 cm/6"  
RU 6055-15/2

Crile-Wood



0,4  
18 cm/7"  
RU 6055-18

0,4  
26 cm/10¼"  
RU 6055-26

Crile-Wood

0,4  
20 cm/8"  
RU 6055-20

0,4  
31 cm/12¼"  
RU 6055-31

0,4  
23 cm/9"  
RU 6055-23



0,4  
13 cm/5"  
RU 6056-13/1  
**RU 6056-13/1 TI**

glatt  
smooth  
lisa  
lisse  
liscie  
13 cm/5"  
RU 6056-13/2

Halsey



0,2  
12,5 cm/5"  
RU 6057-12

Converse

**TI = TITAN**



Nadelhalter mit Hartmetalleinlagen  
 Needle Holders with Tungsten Carbide Inserts  
 Porta-agujas con placas de carburo tungsteno  
 Porte-aiguilles avec mors en carbure de tungstène  
 Portaghi con placche di carburo di tungsteno



**Rudolf**  
TC



Hegar-Vascular

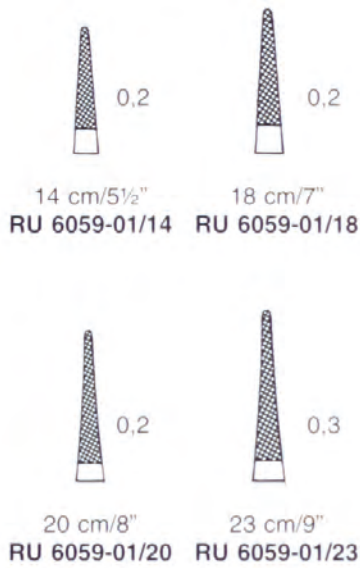

Microvascular

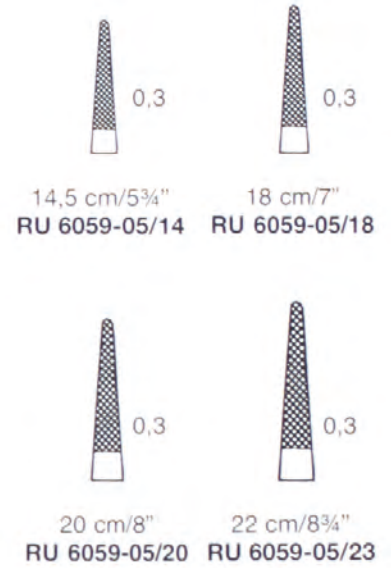

Ryder

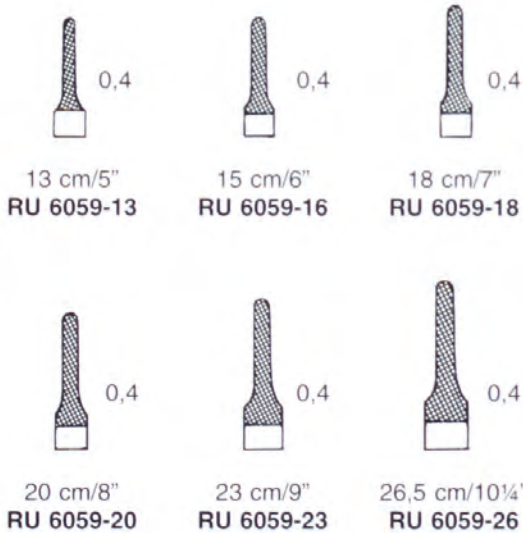

Micro-Ryder

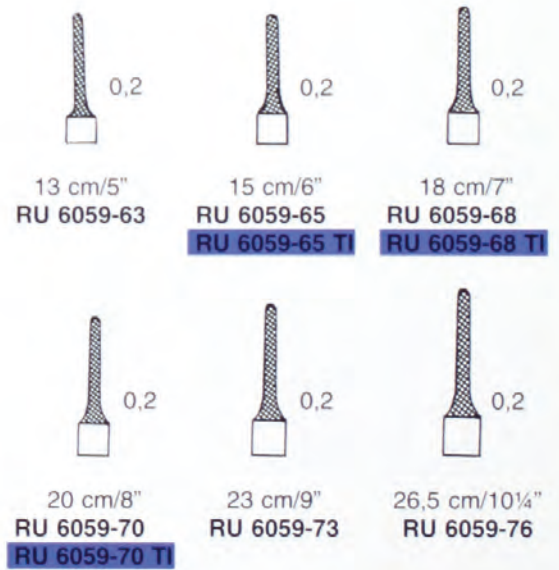

TI = TITAN



Nadelhalter mit Hartmetalleinlagen  
 Needle Holders with Tungsten Carbide Inserts  
 Porta-agujas con placas de carburo tungsteno  
 Porte-aiguilles avec mors en carbure de tungstène  
 Portaghi con placche di carburo di tungsteno



**Rudolf**  
 TC



0,3  
 15 cm/6"  
 RU 6060-00/15

0,3  
 17 cm/6¾"  
 RU 6060-00/17

0,3  
 20 cm/8"  
 RU 6060-00/20

**Rudolf**  
 (Swedish Pattern)

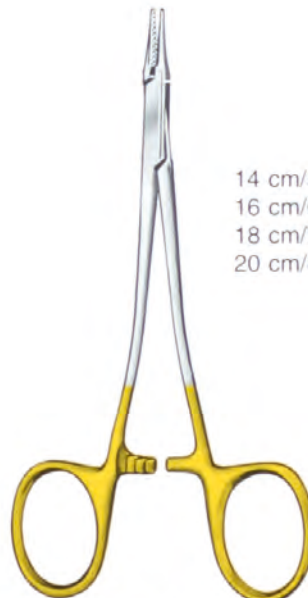

14 cm/5½"  
 16 cm/6¼"  
 18 cm/7"  
 20 cm/8"

**Eufate-Pasqué**



0,3

RU 6060-05/14    RU 6060-05/24  
 RU 6060-05/16    RU 6060-05/26  
 RU 6060-05/18    RU 6060-05/28  
 RU 6060-05/20    RU 6060-05/30



0,4

14 cm/5½"    RU 6060-07/14  
 17 cm/6¾"    RU 6060-07/17  
 19 cm/7½"    RU 6060-07/19

**Lemmon**



0,4

18 cm/7"    RU 6060-18  
 26 cm/10¼"    RU 6060-26

**Sarot**



**Nadelhalter mit Hartmetalleinlagen**  
**Needle Holders with Tungsten Carbide Inserts**  
**Porta-agujas con placas de carburo tungsteno**  
**Porte-aiguilles avec mors en carbure de tungstène**  
**Portaghi con placche di carburo di tungsteno**



**Rudolf**  
**TC**

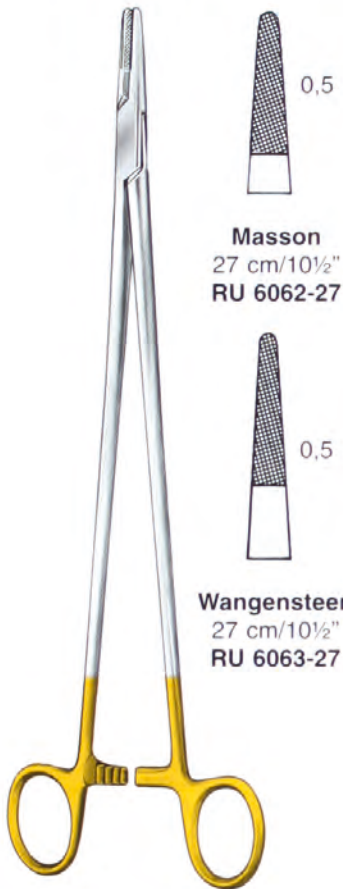

**Masson**  
 27 cm/10½"  
 RU 6062-27

**Wangenstein**  
 27 cm/10½"  
 RU 6063-27



**Finocchietto**



20 cm/8"  
 RU 6064-20



27 cm/10½"  
 RU 6064-27



20 cm/8"  
 RU 6067-18/00



20 cm/8"  
 RU 6068-20



18 cm/7"  
 RU 6069-18



**Mathieu-Kocher**



14 cm/5½"  
 RU 6070-14



17 cm/6¾"  
 RU 6070-17



20 cm/8"  
 RU 6070-20



**Zweifel**

20 cm/8" RU 6071-02/20  
 23 cm/9" RU 6071-02/23

Nadelhalter mit Hartmetalleinlagen  
 Needle Holders with Tungsten Carbide Inserts  
 Porta-agujas con placas de carburo tungsteno  
 Porte-aiguilles avec mors en carbure de tungstène  
 Portaghi con placche di carburo di tungsteno



**Rudolf**  
TC



0,5  
 20 cm/8"  
**RU 6071-20**  
 0,5  
 25 cm/10"  
**RU 6071-25**



0,3  
 14,5 cm/5¾"  
**RU 6082-14**  
 18,0 cm/7"  
**RU 6082-18**  
 21,5 cm/8½"  
**RU 6082-22**

Castroviejo



glatt  
smooth  
lisas  
lisses  
liscie

0,3

14 cm/5½" **RU 6082-14/1** **RU 6082-14/2**  
 18 cm/7" **RU 6082-18/1** **RU 6082-18/2**  
 21 cm/8¼" **RU 6082-21/1** **RU 6082-21/2**  
**RU 6082-18/2 TI**  
**RU 6082-21/2 TI**

0,3

14 cm/5½" **RU 6083-14/1** **RU 6083-14/2**  
 18 cm/7" **RU 6083-18/1** **RU 6083-18/2**  
 21 cm/8¼" **RU 6083-21/1** **RU 6083-21/2**

Castroviejo



0,4

14 cm/5½"  
**RU 6084-14/1**

glatt  
smooth  
lisas  
lisses  
liscie

14 cm/5½"  
**RU 6084-14/2**

Kalt

**TI = TITAN**



**Nadelhalter mit Hartmetalleinlagen**  
**Needle Holders with Tungsten Carbide Inserts**  
**Porta-agujas con placas de carburo tungsteno**  
**Porte-aiguilles avec mors en carbure de tungstène**  
**Portaghi con placche di carburo di tungsteno**



**Rudolf**  
**TC**



**Barraquer**  
 14 cm/5½"  
 RU 6085-14



**Castroviejo**  
 13 cm/5"  
 RU 6086-13



**Hepp-Scheidel**

0,3  
 18 cm/7"  
 RU 6087-18/1

glatt  
 smooth  
 lisa  
 lisse  
 liscie

18 cm/7"  
 RU 6087-18/2



**Jacobson**

0,4  
 18 cm/7"  
 RU 6090-18

0,3  
 20 cm/8"  
 RU 6090-20

0,4  
 23 cm/8¾"  
 RU 6090-23



**Diethrich**

0,3

|          |  |         |
|----------|--|---------|
| gerade   |  | gebogen |
| straight |  | curved  |
| rectas   |  | curvas  |
| droites  |  | courbes |
| rette    |  | curve   |

|           |            |            |
|-----------|------------|------------|
| 16 cm/6¼" | RU 6092-16 | RU 6093-16 |
| 18 cm/7"  | RU 6092-18 | RU 6093-18 |
| 20 cm/8"  | RU 6092-20 | RU 6093-20 |
| 23 cm/9"  | RU 6092-23 | RU 6093-23 |
| 25 cm/10" | RU 6092-25 | RU 6093-25 |

Gewebe- und Organfaßzangen  
Tissue and Organ Grasping Forceps  
Pinzas para coger tejidos y órganos  
Pinces à tissue et à saisir les organes  
Pinze per afferrare tessuti ed organi

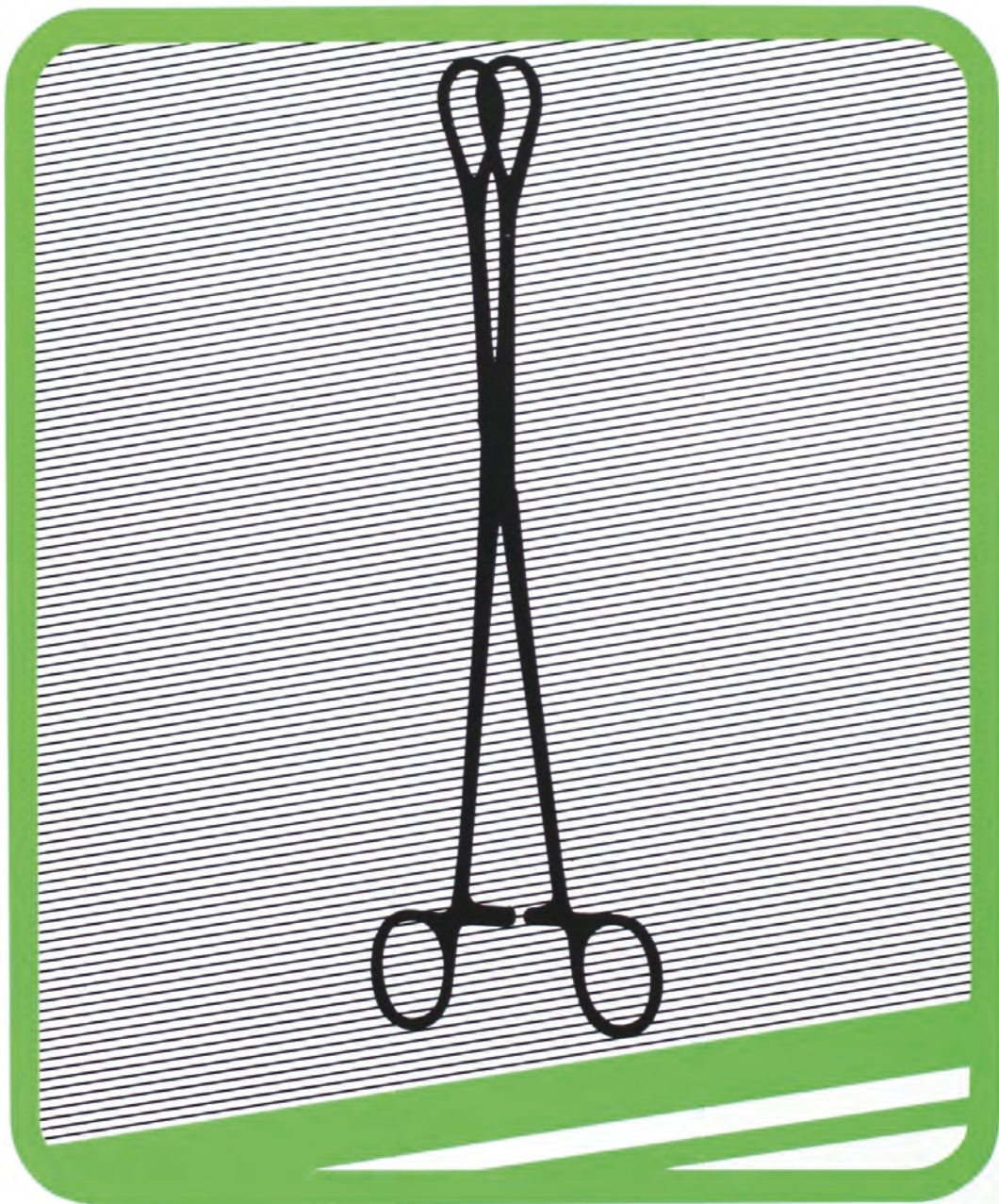



Gewebe- und Organfaßzangen  
 Tissue and Organ Grasping Forceps  
 Pinzas para coger tejidos y órganos  
 Pinces à tissue et à saisir les organes  
 Pinze per afferrare tessuti ed organi



**Allis-Atrauma**

16 cm/6<sup>1</sup>/<sub>4</sub>"    **RU 6505-16**  
 20 cm/8"    **RU 6505-20**  
 25 cm/10"    **RU 6505-25**  
 30 cm/12"    **RU 6505-30**



**Williams**

16 cm/6<sup>1</sup>/<sub>4</sub>"  
**RU 6514-16**



**Babcock-Atrauma**



**Babcock (Standard)**

| cm/in                                 |                   |                   |
|---------------------------------------|-------------------|-------------------|
| 16 cm/6 <sup>1</sup> / <sub>4</sub> " | <b>RU 6517-16</b> | <b>RU 6518-16</b> |
| 18 cm/7"                              |                   | <b>RU 6518-18</b> |
| 20 cm/8"                              | <b>RU 6517-20</b> | <b>RU 6518-20</b> |
| 24 cm/9 <sup>1</sup> / <sub>2</sub> " |                   | <b>RU 6518-24</b> |

Gewebe- und Organfaßzangen  
 Tissue and Organ Grasping Forceps  
 Pinzas para coger tejidos y órganos  
 Pinces à tissu et à saisir les organes  
 Pinze per afferrare tessuti ed organi



|            | cm | in |            |
|------------|----|----|------------|
| RU 6520-18 | 18 | 7  |            |
| RU 6520-20 | 20 | 8  | RU 6522-20 |
|            | 23 | 9  | RU 6522-23 |



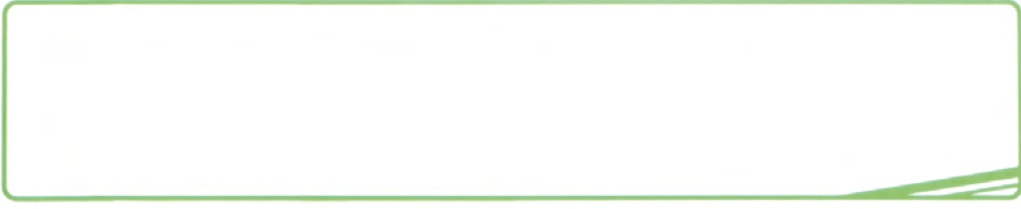



Rippenscheren, Sternumscheren  
Rib Shears, Sternum Scissors  
Costótomos, Tijeras de esternón  
Costotomes, Ciseaux à sternum  
Costotomi, Forbici per sterno





Rippenscheren, Sternumscheren  
Rib Shears, Sternum Scissors  
Costótomos, Tijeras de esternón  
Costotomes, Ciseaux à sternum  
Costotomi, Forbici per sterno



**Collin**  
22 cm/8<sup>3</sup>/<sub>4</sub>"  
RU 2805-22



**Gluck**  
22 cm/8<sup>3</sup>/<sub>4</sub>"  
RU 2820-22



**Stille**  
21 cm/8<sup>1</sup>/<sub>4</sub>"  
RU 2825-21

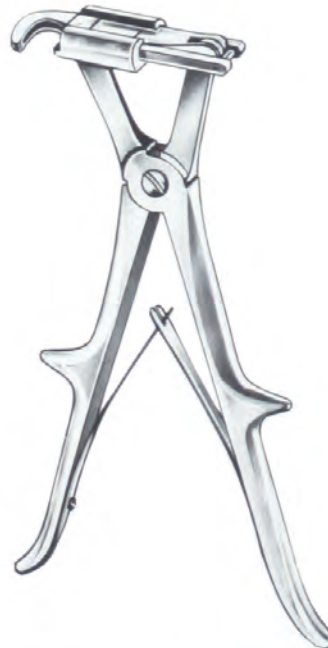

**Sauerbruch**  
24 cm/9<sup>1</sup>/<sub>2</sub>" RU 7500-24  
26 cm/10<sup>1</sup>/<sub>4</sub>" RU 7500-26



**Giertz-Stille**  
27 cm/10<sup>1</sup>/<sub>2</sub>"  
RU 7501-27



**Bethune**  
34 cm/13<sup>1</sup>/<sub>2</sub>"  
RU 7504-34



**Brunner**  
32 cm/12<sup>1</sup>/<sub>2</sub>"

**RU 7505-32**  
für die rechte Hand  
for the right hand  
para la mano derecha  
pour la main droite  
per la mano destra

**RU 7506-32**  
für die linke Hand  
for the left hand  
para la mano izquierda  
pour la main gauche  
per la mano sinistra



**Lebsche**  
24,5 cm/9<sup>3</sup>/<sub>4</sub>"  
RU 7507-24



Rippensperrer  
Rib Spreaders  
Separadores costales  
Ecarteurs costaux  
Divaricatori costali





**Rippensperrer**  
**Rib Spreaders**  
**Separadores costales**  
**Ecarteurs costaux**  
**Divaricatori costali**

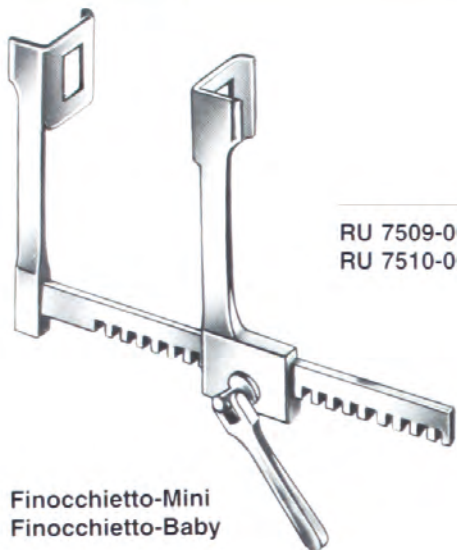

|            | a     | b     | c     |
|------------|-------|-------|-------|
| RU 7509-00 | 6 mm  | 7 mm  | 36 mm |
| RU 7510-00 | 18 mm | 20 mm | 80 mm |

**Finocchietto-Mini**  
**Finocchietto-Baby**

Abmessungs-Schema  
 scheme of dimensions  
 esquema de dimensiones  
 schéma des dimensions  
 schema per le dimensioni

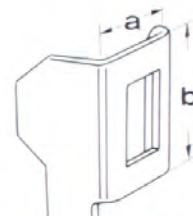

Größe der Valve  
 size of blades  
 tamaño de la valva  
 dimensions des valves  
 dimensioni delle valve

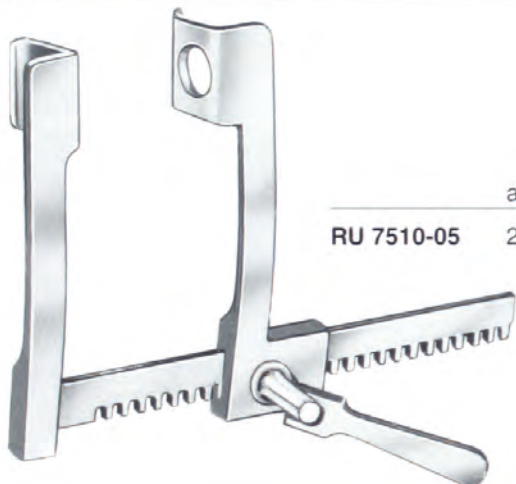

|            | a     | b     | c      |
|------------|-------|-------|--------|
| RU 7510-05 | 28 mm | 32 mm | 120 mm |

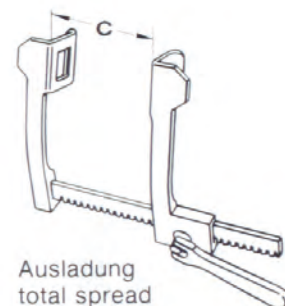

Ausladung  
 total spread  
 apertura total  
 ouverture totale  
 apertura totale

◀ 70 mm ▶



**Struck**  
**RU 7511-00**

bestehend aus:  
 consisting of:  
 compuesto de:  
 consistant en:  
 composto da:  
 RU 7511-10, RU 7511-18, RU 7511-19

für Kleinkinder  
 for children  
 para niños  
 pour des enfants  
 per bambini



10 x 10 mm  
**RU 7511-15**



10 x 15 mm  
**RU 7511-16**

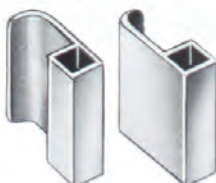

10 x 20 mm  
**RU 7511-17**



15 x 20 mm  
**RU 7511-18**



20 x 20 mm  
**RU 7511-19**



**Finocchietto**

|            | a     | b     | c      |
|------------|-------|-------|--------|
| RU 7512-01 | 36 mm | 45 mm | 140 mm |
| RU 7512-03 | 44 mm | 65 mm | 200 mm |
| RU 7512-04 | 44 mm | 65 mm | 250 mm |
| RU 7512-05 | 44 mm | 65 mm | 300 mm |
| RU 7512-06 | 65 mm | 65 mm | 200 mm |
| RU 7512-07 | 65 mm | 65 mm | 250 mm |
| RU 7512-08 | 65 mm | 65 mm | 300 mm |

mit 2 Paar auswechselbaren Valven  
with 2 pairs of interchangeable blades  
con 2 pares de valvas intercambiables  
avec 2 paires de valves interchangeables  
con 2 paia di valve

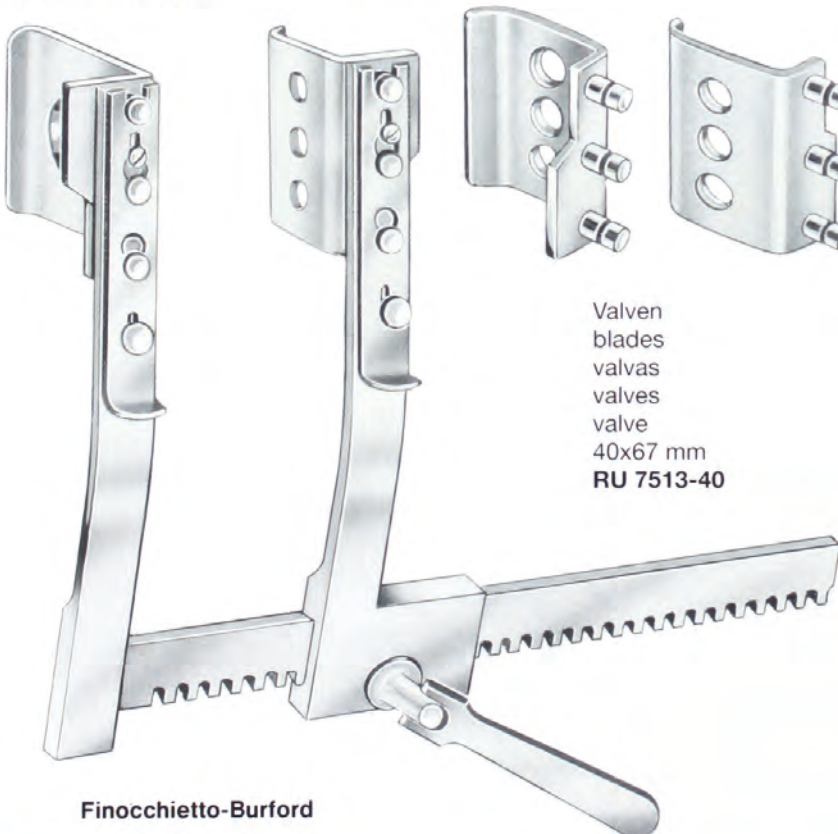

**Finocchietto-Burford**

Valven  
blades  
valvas  
valves  
valves  
valve  
40x67 mm  
**RU 7513-40**

Valven  
blades  
valvas  
valves  
valves  
valve  
80x67 mm  
**RU 7513-41**

Spreizweite  
total spread  
apertura total  
ouverture totale  
apertura totale

200 mm/8" **RU 7513-01**  
250 mm/10" **RU 7513-02**  
305 mm/12" **RU 7513-03**



**Finocchietto**

|            | a     | b     | c      |
|------------|-------|-------|--------|
| RU 7512-01 | 36 mm | 45 mm | 140 mm |
| RU 7512-03 | 44 mm | 65 mm | 200 mm |
| RU 7512-04 | 44 mm | 65 mm | 250 mm |
| RU 7512-05 | 44 mm | 65 mm | 300 mm |
| RU 7512-06 | 65 mm | 65 mm | 200 mm |
| RU 7512-07 | 65 mm | 65 mm | 250 mm |
| RU 7512-08 | 65 mm | 56 mm | 400 mm |

mit 2 Paar auswechselbaren Valven  
with 2 pairs of interchangeable blades  
con 2 pares de valvas intercambiables  
avec 2 paires de valves interchangeables  
con 2 paia di valve

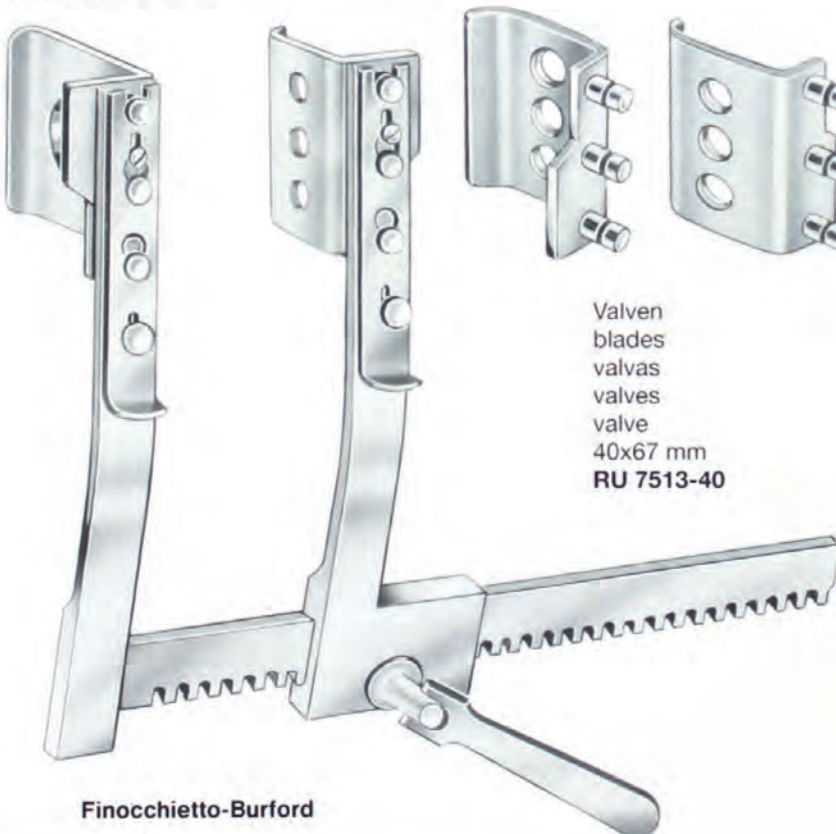

**Finocchietto-Burford**

Valven  
blades  
valvas  
valves  
valve  
40x67 mm  
**RU 7513-40**

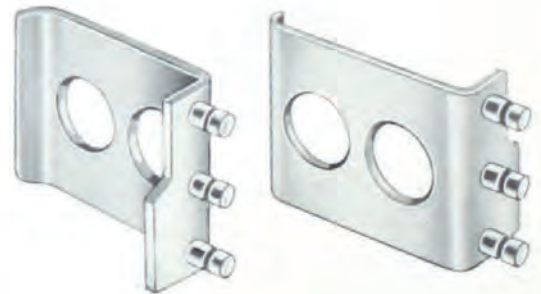

Valven  
blades  
valvas  
valves  
valve  
80x67 mm  
**RU 7513-41**

Spreizweite  
total spread  
apertura total  
ouverture totale  
apertura totale

200 mm/8" **RU 7513-01**  
250 mm/10" **RU 7513-02**  
305 mm/12" **RU 7513-03**





Rippensperrer  
 Rib Spreaders  
 Separadores costales  
 Ecarteurs costaux  
 Divaricatori costali

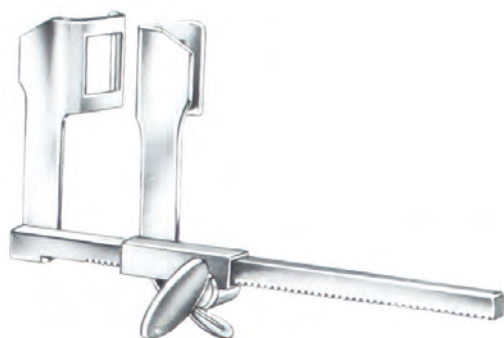

Haight

|            | a     | b     | c      |
|------------|-------|-------|--------|
| RU 7516-00 | 30 mm | 30 mm | 115 mm |



Rienhoff-Finocchietto

|            | a     | b     | c      |
|------------|-------|-------|--------|
| RU 7516-05 | 20 mm | 25 mm | 150 mm |



Cooley  
 (Cooley-Baby)

|            | a     | b     | c      |
|------------|-------|-------|--------|
| RU 7518-01 | 15 mm | 30 mm | 100 mm |
| RU 7518-02 | 21 mm | 45 mm | 145 mm |
| RU 7518-03 | 32 mm | 50 mm | 190 mm |



**De Bakey**  
**RU 7520-00**  
 mit 3 Paar Blättern  
 with 3 pairs of blades  
 con 3 pares de valvas  
 avec 3 paires de valves  
 con 3 paia di valve  
 (RU 7520-21, RU 7520-22, RU 7520-23)

**RU 7520-10**  
 Sperrer, allein  
 Spreader, only  
 Separador, suelto  
 Ecarteur, seul  
 Divaricatore, solo



**De Bakey**  
**RU 7521-00**  
 mit 3 Paar Blättern  
 with 3 pairs of blades  
 con 3 pares de valvas  
 avec 3 paires de valves  
 con 3 paia di valve

**RU 7521-10**  
 Sperrer, allein  
 Spreader, only  
 Separador, suelto  
 Ecarteur, seul  
 Divaricatore, solo





Rippensperrer  
 Rib Spreaders  
 Separadores costales  
 Ecarteurs costaux  
 Divaricatori costali

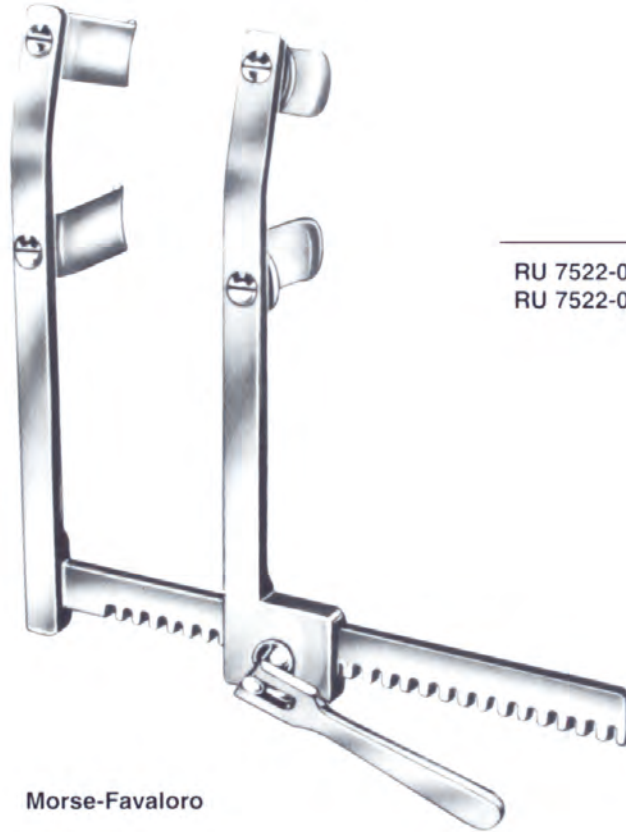

|            | a     | b     | c      |
|------------|-------|-------|--------|
| RU 7522-01 | 12 mm | 20 mm | 155 mm |
| RU 7522-02 | 40 mm | 20 mm | 155 mm |

Morse-Favaloro

Thoraxsperrer  
 Thoracic retractor  
 Separador torácico  
 Ecarteur thoracique  
 Divaricatore per il torace

75x85 mm  
 RU 7523-21

48x65mm  
 RU 7523-22



**RU 7523-10**  
 Sperrer, allein  
 Retractor, only  
 Separador, suelto  
 Ecarteur, seul  
 Divaricatore, solo

**(Mercedes-Retractor)**

**RU 7523-00**  
 komplett  
 complete  
 completo  
 complet  
 completo



**Rudolf**  
 ALU

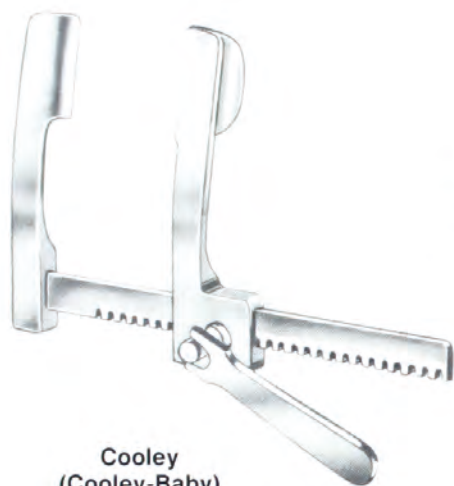

Cooley  
 (Cooley-Baby)

|            | a     | b     | c      |
|------------|-------|-------|--------|
| RU 7524-01 | 15 mm | 15 mm | 70 mm  |
| RU 7524-02 | 15 mm | 30 mm | 100 mm |
| RU 7524-04 | 30 mm | 50 mm | 185 mm |

**Rudolf**  
 ALU



Cooley

für Kleinkinder, mit konkaven Valven  
 for children with, concave blades  
 para niños, con valvas concavas  
 pour des enfants, avec valves concaves  
 per bambini, con valve concavi

|            | a     | b     | c     |
|------------|-------|-------|-------|
| RU 7524-11 | 11 mm | 15 mm | 90 mm |

**Rudolf**  
 ALU

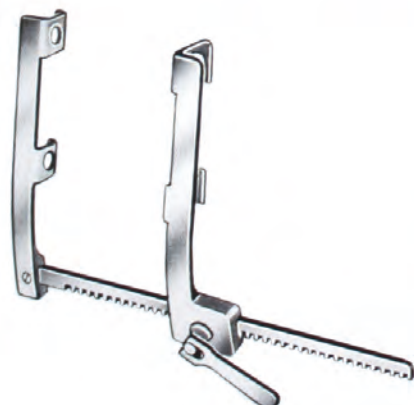

Finocchietto modif.

|            | a     | b     | c      |
|------------|-------|-------|--------|
| RU 7524-21 | 10 mm | 15 mm | 120 mm |



Rippensperrer aus Leichtmetall  
 Rib Spreaders Made of Aluminium  
 Separadores costales de aluminio  
 Ecarteurs costaux en aluminium  
 Divaricatori costali in alluminio



**Rudolf**  
 ALU



Castaneda

|            | a     | b     | c      |
|------------|-------|-------|--------|
| RU 7525-01 | 12 mm | 32 mm | 70 mm  |
| RU 7525-02 | 15 mm | 45 mm | 75 mm  |
| RU 7525-03 | 15 mm | 60 mm | 100 mm |

**Rudolf**  
 ALU



Morse-Favaloro

|            | a     | b     | c      |
|------------|-------|-------|--------|
| RU 7526-01 | 20 mm | 20 mm | 155 mm |
| RU 7526-02 | 40 mm | 20 mm | 155 mm |

**Rudolf**  
 ALU

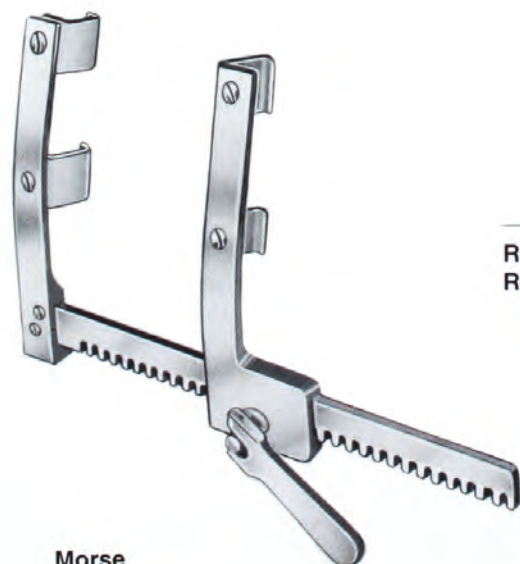

Morse

|            | a     | b     | c      |
|------------|-------|-------|--------|
| RU 7526-11 | 20 mm | 20 mm | 165 mm |
| RU 7526-12 | 20 mm | 30 mm | 210 mm |



**rudolf**  
ALU

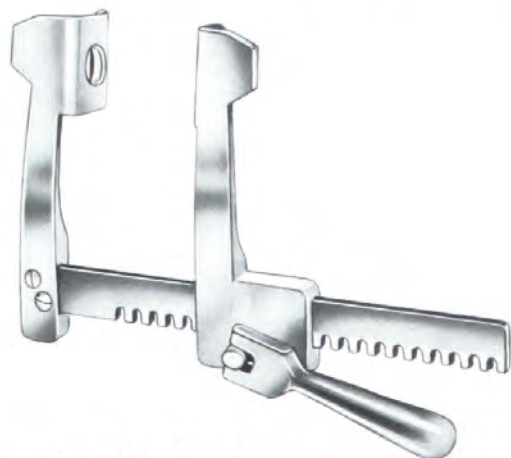

|            | a     | b     | c     |
|------------|-------|-------|-------|
| RU 7527-01 | 12 mm | 15 mm | 70 mm |
| RU 7527-02 | 27 mm | 30 mm | 95 mm |

Finocchietto-Baby-Haight

**rudolf**  
ALU



|            | a     | b     | c      |
|------------|-------|-------|--------|
| RU 7527-11 | 30 mm | 45 mm | 140 mm |
| RU 7527-12 | 40 mm | 65 mm | 175 mm |
| RU 7527-13 | 75 mm | 65 mm | 175 mm |

Finocchietto

**rudolf**  
ALU



|  | a              | b              | c                |
|--|----------------|----------------|------------------|
| für Kinder / for children / para niños<br>pour enfants / per bambini |                |                |                  |
| RU 7528-00   | 48 mm<br>34 mm | 42 mm<br>42 mm | 135 mm<br>135 mm |

**Burford**  
 mit 2 Paar Valven  
 with 2 pairs of blades  
 con 2 pares de valvas  
 avec 2 paires de valves  
 con 2 paia di valve

|            |                |                |        |
|------------|----------------|----------------|--------|
| RU 7528-01 | 67 mm<br>48 mm | 62 mm<br>62 mm | 180 mm |
| RU 7528-02 | 67 mm<br>48 mm | 62 mm<br>62 mm | 260 mm |
| RU 7528-03 | 67 mm<br>48 mm | 62 mm<br>62 mm | 300 mm |



Rippensperrer, Rippenkontraktoren  
 Rib Spreaders, Rib Contractors  
 Separadores costales, Aproximadores costales  
 Ecarteurs costaux, Rapprocheurs costaux  
 Divaricatori costali, Approssimatori costali



**Rudolf**  
TITAN



Neonatal Sternumsperrer mit 2 Paar auswechselbaren Valven  
 Neonatal sternum spreader with 2 pairs of interchangeable blades  
 Separador de esternón para recién nacidos con 2 pares de valvas intercambiables  
 Ecarteur à sternum pour des nouveaux-nés avec 2 paires de valves interchangeables  
 Divaricatori per sterno per neonati con 2 paia di valve

**RU 7530-00TI**



**Sellors**  
19 cm/7 1/2"  
RU 7533-19



**Bailey-Baby**  
14 cm/5 1/2"  
RU 7534-14



**Bailey**  
18,5 cm/7 1/4"  
RU 7536-16



**Bailey-Gibbon**  
16 cm/6 1/4"  
RU 7537-16

**TI = TITAN**

Gefäßklemmen, Atrauma Klemmen  
Vessel Clamps, Atraumatic Clamps  
Clamps vasculares, Clamps atraumaticos  
Clamps vasculaires, Clamps atraumatiques  
Pinze vascolari atraumatiche

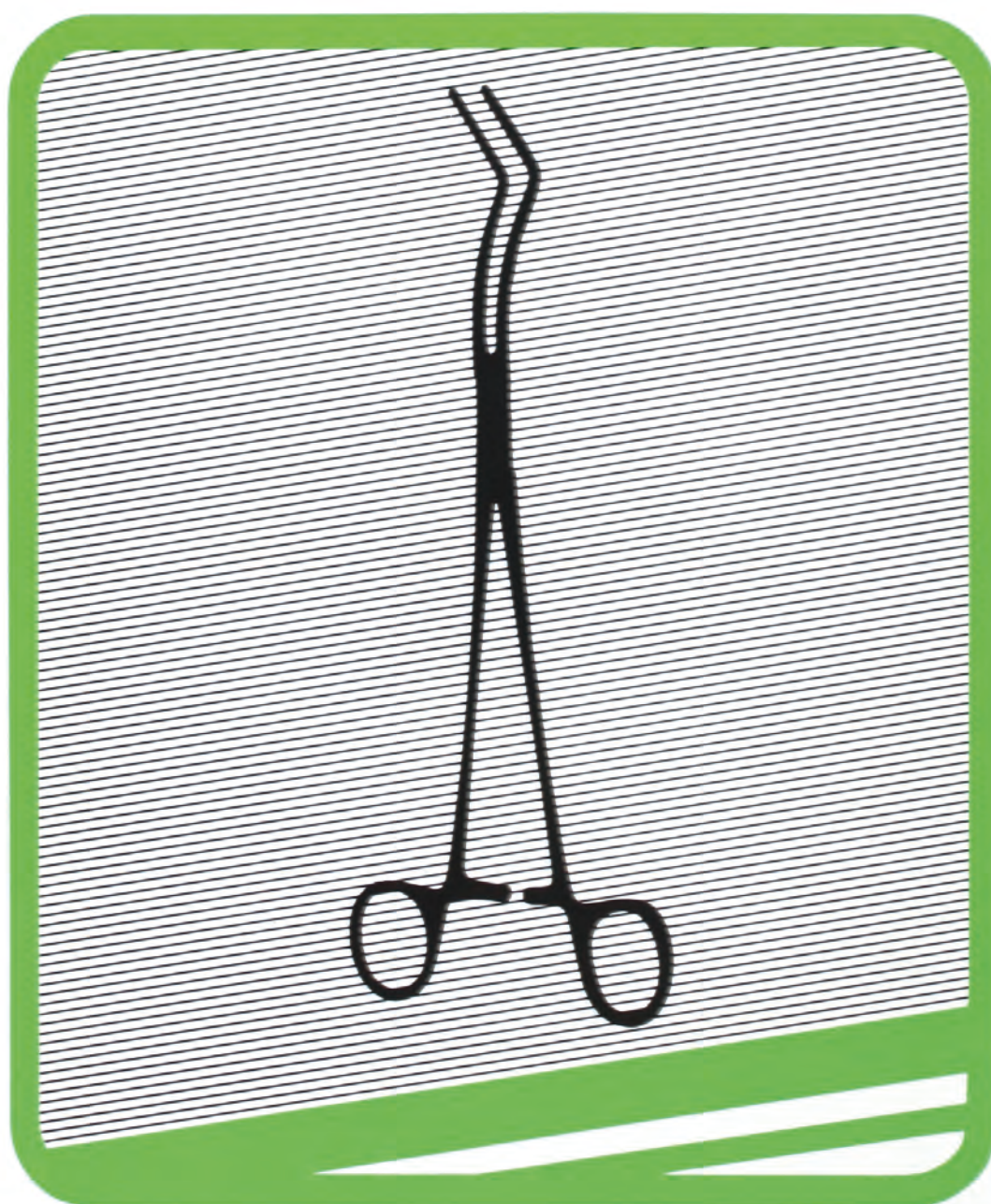



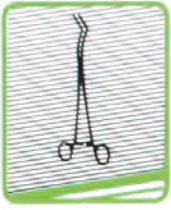

**Bronchusklemmen, Gefäßklemmen  
Bronchus Clamps, Blood Vessel Clamps  
Pinzas-clamps para bronquios y vasos  
Pincers-clamps à bronches, Pincers vasculaires  
Pinze per bronchi, Pinze cardiovascolari**



Bronchusklemmen  
Bronchus clamps  
Pinzas-clamps para bronquios  
Pincers-clamps à bronches  
Pinze per bronchi

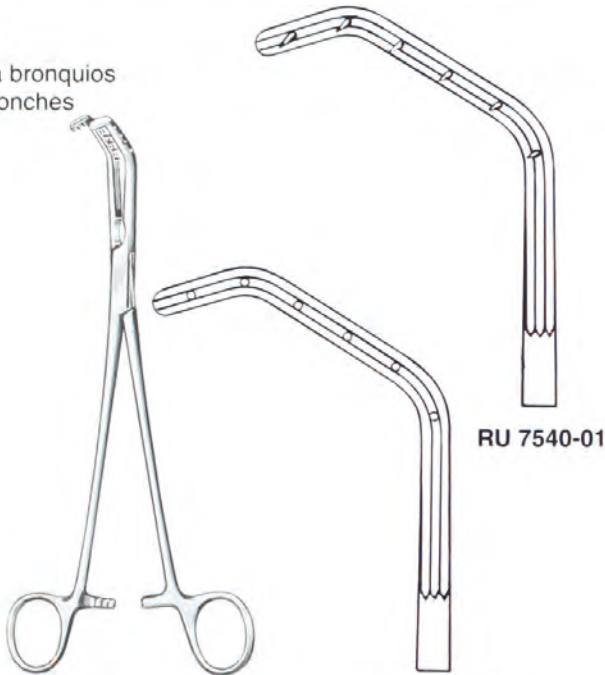

**Price-Thomas**  
22 cm/8<sup>3</sup>/<sub>4</sub>"

**RU 7540-02**



**Price-Thomas**  
22 cm/8<sup>3</sup>/<sub>4</sub>"  
**RU 7540-22**



**Semb**  
24 cm/9<sup>1</sup>/<sub>2</sub>"

**RU 7549-24**

**RU 7548-24**

Lungenfaßzangen  
Lung grasping forceps  
Pinzas-clamps pulmonares  
Pincers-clamps à poumons  
Pinze per polmone



**Lovelace**  
20 cm/8"  
**RU 7560-20**

**Lovelace**  
20 cm/8"  
**RU 7561-20**

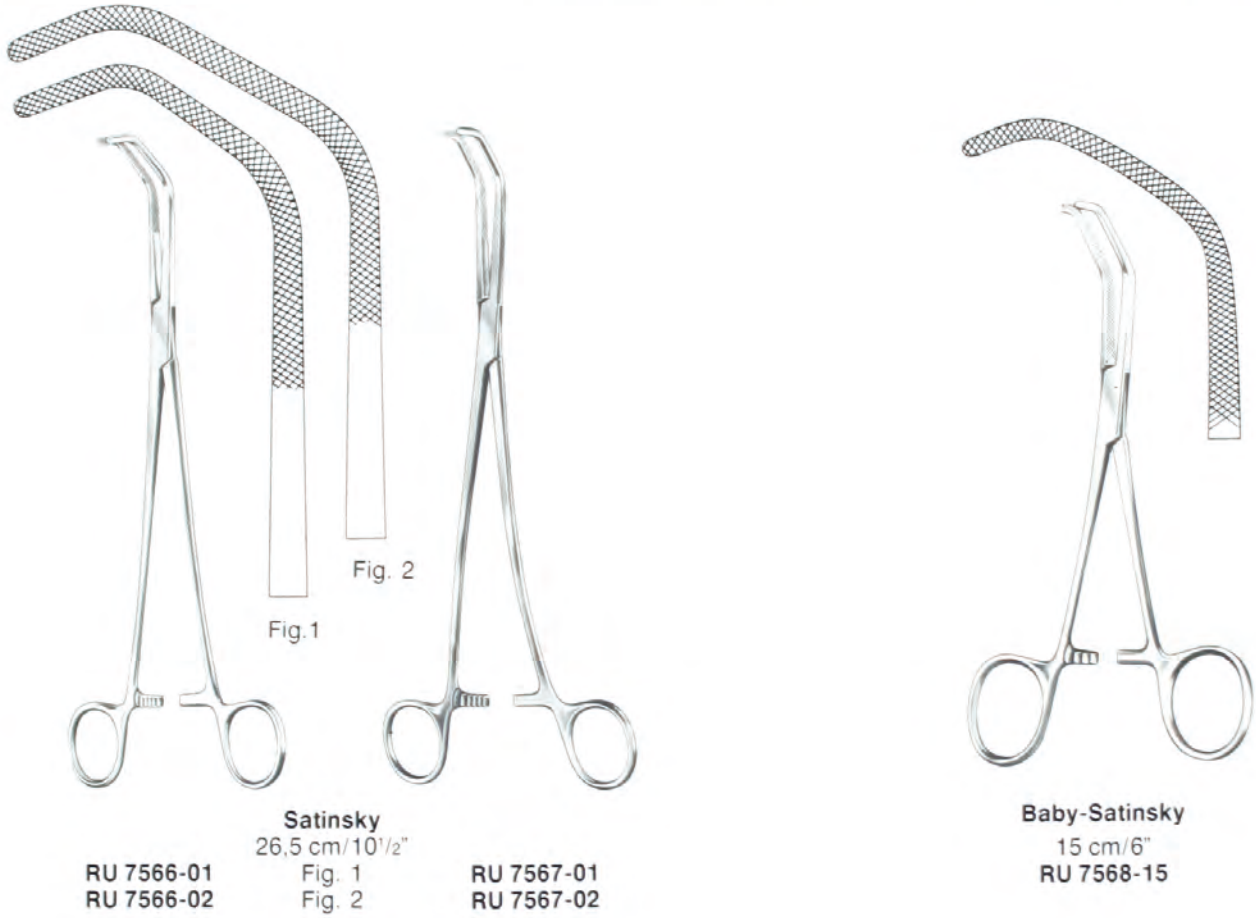
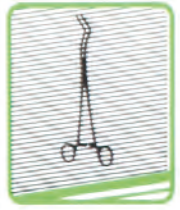

**Satinsky**  
 26,5 cm/10 1/2"  
 RU 7566-01 Fig. 1  
 RU 7566-02 Fig. 2

RU 7567-01  
 RU 7567-02

**Baby-Satinsky**  
 15 cm/6"  
 RU 7568-15

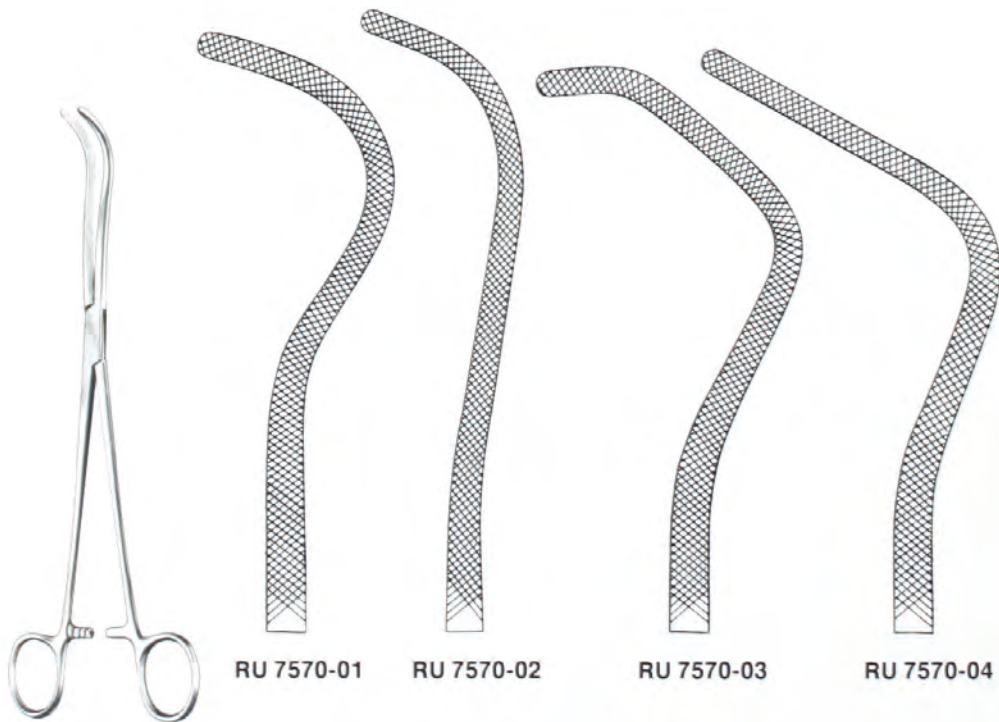

**Harken**  
 24 cm/9 1/2"

RU 7570-01    RU 7570-02    RU 7570-03    RU 7570-04



**Atrauma Cardiovascular-Klemmen**  
**Atrauma Cardiovascular Forceps**  
**Atrauma Pinzas-clamps cardiovasculares**  
**Pinces vasculaires atraumatiques**  
**Pinze cardiovascolari atraumatiche**



**Zahnung nach De Bakey:**

Die ATRAUMA-Klemmen mit Tradition. Neben Herz- und Gefäß-Chirurgie auch für andere atraumatische Anwendungsbereiche und Operationstechniken bewährt. Unverrückbares, exaktes Fassen des Gewebes, sicheres und fein dosierbares Abklemmen der Gefäße.

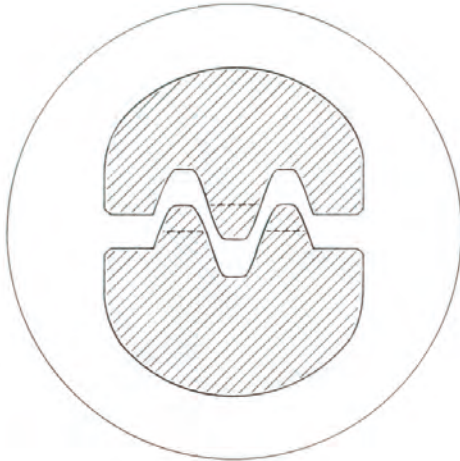

**Toothing according to De Bakey:**

The traditional ATRAUMA clamps. Apart from cardiovascular surgery, they are also approved for other atraumatic application and surgery techniques. Firm and precise seizing of tissues, safe and delicately controlled clamping effect.

**Dentado según De Bakey:**

Pinzas ATRAUMA tradicionales. Probadas no sólo en la cirugía cardiovascular, sino también en otros sectores de aplicaciones y técnicas de operación. Clampaje firme y exacto del tejido, «clamping» seguro de los vasos.

**Denture d'après De Bakey:**

Le clamp ATRAUMA traditionnel. Eprouvé dans la chirurgie du thorax et vasculaire de même que dans d'autres domaines et pour d'autres techniques opératoires non-traumatisantes. Préhension parfaite et exacte du tissu, clampage sûr des vaisseaux.

**Dentatura secondo De Bakey:**

Le pinze ATRAUMA a lunga tradizione. Eccellenti risultati sia nella chirurgia cardiaca e vascolare che anche in altri campi di applicazione e di tecniche operative atraumatiche. Presa fissa ed esatta dei vasi.

**Zahnung nach Cooley:**

Durch die sehr schmalen Maulteile einsetzbar in extrem begrenztem Operationsfeld. Besonders bei Säuglings- und Herzchirurgie. Fester Griff ohne Quetschungen.

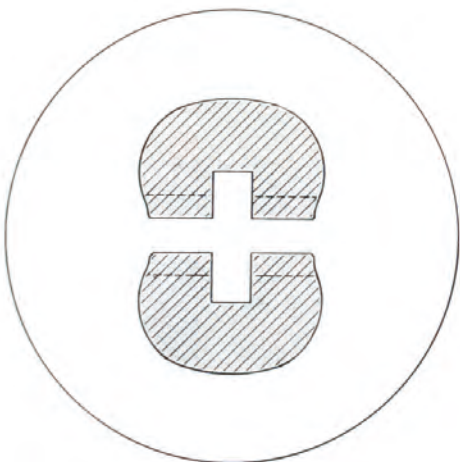

**Toothing according to Cooley:**

Very narrow jaws for application in extremely limited operational field. Particularly approved for cardiovascular surgery and pediatry. Firm grip without squeezing.

**Dentado según Cooley:**

Debido a la boca muy estrecha se puede aplicar en campos operatorios extremadamente pequeños. Especialmente para cirugía infantil y del corazón. Clampaje fuerte sin contusiones.

**Denture d'après Cooley:**

Les mors très étroits permettent d'intervenir dans des parties extrêmement limitées du champ opératoire. En particulier pour la chirurgie cardiovasculaire et infantile. Prise sûre sans écrasement.

**Dentatura secondo Cooley:**

I becchi sottilissimi permettono l'uso in campi operativi estremamente limitati, soprattutto nella chirurgia cardiaca e infantile. Presa sicura senza contusioni.

**Atrauma-Pinzetten**  
**Atrauma Forceps**  
**Pinzas de disección atrauma**  
**Pinces atraumatiques**  
**Pinze cardiovascolari atraumatiche**



**Rudolf**  
TC



**Rudolf**  
DE BAKEY



Maulbreite  
width of jaw  
ancho de boca  
largeur du mors  
larghezza

|             | 1,5 mm        | 2,0 mm        | 2,7 mm        | 3,5 mm        | 1,2 mm           | 2,0 mm           | 1,2 mm     |
|-------------|---------------|---------------|---------------|---------------|------------------|------------------|------------|
| del morso   | RU 7571-15/15 | RU 7571-20/15 | RU 7571-27/15 | RU 7571-35/15 | RU 7575-12/18    | RU 7575-20/18    | RU 7576-15 |
| 15 cm/6"    |               |               |               |               | RU 7575-12/18 TI | RU 7575-20/18 TI | RU 7576-18 |
| 18 cm/7"    |               |               |               |               |                  |                  |            |
| 19,5 cm/7½" | RU 7571-15/19 | RU 7571-20/19 | RU 7571-27/19 | RU 7571-35/19 |                  |                  |            |
| 21 cm/8¼"   |               |               |               |               | RU 7575-12/21    | RU 7575-20/21    |            |
| 24 cm/9½"   | RU 7571-15/24 | RU 7571-20/24 | RU 7571-27/24 | RU 7571-35/24 |                  |                  |            |



1,5 mm

15 cm/6"  
RU 7576-25

19,5 cm/7¾"  
RU 7576-29

24 cm/9½"  
RU 7576-34

De Bakey-Diethrich



2,0 mm

18 cm/7"  
RU 7577-18

20 cm/8"  
RU 7577-20

De Bakey Bayonet

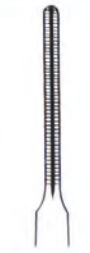

2,0 mm

15 cm/6"  
RU 7579-15

19,5 cm/7½"  
RU 7579-19

Cooley



12 cm/4¾"  
RU 7585-12

15 cm/6"  
RU 7585-15

Adson

TI = TITAN



**Atrauma-Pinzetten**  
**Atrauma Forceps**  
**Pinzas de disección atrauma**  
**Pinces atraumatiques**  
**Pinze cardiovascolari atraumatiche**



**Rudolf**  
TITAN

**Rudolf**  
DE BAKEY

Maulbreite  
width of jaw  
ancho de boca  
largeur du mors  
larghezza  
del morso

|             | 1,0 mm                  | 1,5 mm                  | 1,8 mm                  | 2,0 mm                  | 2,8 mm                  |
|-------------|-------------------------|-------------------------|-------------------------|-------------------------|-------------------------|
| 15 cm/6"    | <b>RU 7580-10/15 TI</b> | <b>RU 7580-15/15 TI</b> | <b>RU 7580-18/15 TI</b> | <b>RU 7580-20/15 TI</b> | <b>RU 7580-28/15 TI</b> |
| 19,5 cm/7¾" | <b>RU 7580-10/19 TI</b> | <b>RU 7580-15/19 TI</b> | <b>RU 7580-18/19 TI</b> | <b>RU 7580-20/19 TI</b> | <b>RU 7580-28/19 TI</b> |
| 24 cm/9½"   | <b>RU 7580-10/24 TI</b> | <b>RU 7580-15/24 TI</b> | <b>RU 7580-18/24 TI</b> | <b>RU 7580-20/24 TI</b> | <b>RU 7580-28/24 TI</b> |

De Bakey



Maulbreite  
width of jaw  
ancho de boca  
largeur du mors  
larghezza  
del morso

|           | 1,5 mm            | 2,0 mm            | 2,7 mm            | 3,5 mm            |
|-----------|-------------------|-------------------|-------------------|-------------------|
| 16 cm/6¼" | <b>RU 7580-16</b> | <b>RU 7581-16</b> | <b>RU 7582-16</b> | <b>RU 7583-16</b> |
| 20 cm/8"  | <b>RU 7580-20</b> | <b>RU 7581-20</b> | <b>RU 7582-20</b> | <b>RU 7583-20</b> |
| 24 cm/9½" | <b>RU 7580-24</b> | <b>RU 7581-24</b> | <b>RU 7582-24</b> | <b>RU 7583-24</b> |
| 30 cm/12" | <b>RU 7580-30</b> | <b>RU 7581-30</b> | <b>RU 7582-30</b> | <b>RU 7583-30</b> |

De Bakey



Maulbreite  
width of jaw  
ancho de boca  
largeur du mors  
larghezza  
del morso

|  | 2,0 mm            |
|--|-------------------|
|  | <b>RU 7584-16</b> |
|  | <b>RU 7584-20</b> |
|  | <b>RU 7584-24</b> |
|  | <b>RU 7584-30</b> |

De Bakey

TI = TITAN

Atrauma Bulldogklemmen  
 Atrauma Bulldog Clamps  
 Clamps Bulldog atraumaticos  
 Clamps atraumatiques Bulldog  
 Pinze atraumatiche Bulldog



**Rudolf**  
 DE BAKEY

Anlegezange  
 Setting forceps  
 Pinzas para poner clips  
 Pince pour poser les clips  
 Pinza per applicare clips



23 cm/9"  
 RU 7586-00



RU 7586-07  
 RU 7586-07 TI

8 cm/3"



RU 7587-07  
 RU 7587-07 TI

RU 7586-08  
 RU 7586-08 TI

9 cm/3½"

RU 7587-08  
 RU 7587-08 TI

RU 7586-10  
 RU 7586-10 TI

10,5 cm/4"

RU 7587-10  
 RU 7587-10 TI

RU 7586-12  
 RU 7586-12 TI

13 cm/5"

RU 7587-12  
 RU 7587-12 TI



De Bakey-Diethrich



RU 3934-60

10 mm



RU 3934-64

14 mm



RU 3934-70

20 mm

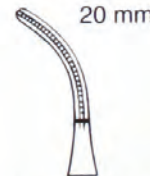

RU 3934-71

20 mm



RU 3935-60

10 mm



RU 3935-64

14 mm



RU 3935-70

20 mm



Atrauma Bulldogklemmen  
 Atrauma Bulldog Clamps  
 Clamps Bulldog atraumaticos  
 Clamps atraumatiques Bulldog  
 Pinze atraumatiche Bulldog



**Rudolf**  
 DE BAKY



**De Bakey**  
 5,0 cm/2"  
 RU 7586-10/50



**De Bakey**  
 4,5 cm/1¾"  
 RU 7586-11/50



**Glover**

|            |            |
|------------|------------|
| RU 7588-06 | 5 cm/2"    |
| RU 7588-07 | 7 cm/2¾"   |
| RU 7588-09 | 8,5 cm/3½" |
| RU 7588-11 | 13 cm/5"   |



**Glover**

|            |            |
|------------|------------|
| RU 7589-06 | 4 cm/1½"   |
| RU 7589-07 | 6,5 cm/2½" |
| RU 7589-09 | 8 cm/3"    |
| RU 7589-11 | 12 cm/4¾"  |



**Glover**  
 5 cm/2"  
 RU 7590-05



**De Bakey-Satinsky**  
 6 cm/2½"  
 RU 7590-07



Atrauma Bulldogklemmen  
 Atrauma Bulldog Clamps  
 Clamps Bulldog atraumaticos  
 Clamps atraumatiques Bulldog  
 Pinze atraumatiche Bulldog



De Bakey  
 8 cm/3¼"  
 RU 7590-09



**Rudolf**  
 DE BAKEY

De Bakey  
 10,5 cm/4¼"  
 RU 7590-10



Santulli  
 7 cm/2¾"  
 RU 7591-07  
 RU 7591-07 TI



Gregory-Soft

9 cm/3½"  
 RU 7591-01

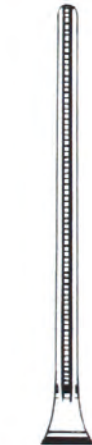

10,5 cm/4"  
 RU 7591-02

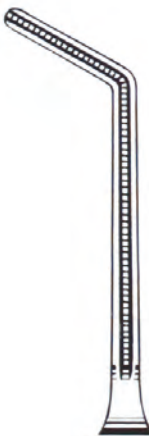

11 cm/4½"  
 RU 7591-09

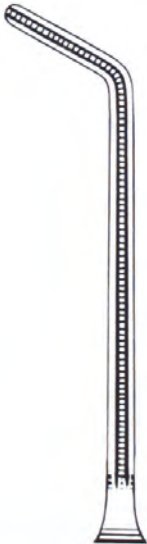

12 cm/4¾"  
 RU 7591-11



11,5 cm/4½"  
 RU 7591-92



11,5 cm/4½"  
 RU 7591-94

TI = TITAN





Atrauma Bulldogklemmen  
Atrauma Bulldog Clamps  
Clamps Bulldog atraumaticos  
Clamps atraumatiques Bulldog  
Pinze atraumatiche Bulldog



Vena  
Arteria

3 cm/1 1/4"  
RU 7592-02/30V  
RU 7592-02/30A

3,5 cm/1 1/2"  
RU 7592-02/35V  
RU 7592-02/35A

4 cm/1 1/2"  
RU 7592-02/40V  
RU 7592-02/40A

5 cm/2"  
RU 7592-02/50V  
RU 7592-02/50A



Vena  
Arteria

3 cm/1 1/4"  
RU 7592-03/30V  
RU 7592-03/30A

3,5 cm/1 1/2"  
RU 7592-03/35V  
RU 7592-03/35A

4 cm/1 1/2"  
RU 7592-03/40V  
RU 7592-03/40A

5 cm/2"  
RU 7592-03/50V  
RU 7592-03/50A



Vena  
Arteria

3 cm/1 1/4"  
RU 7592-05/30V  
RU 7592-05/30A

3,5 cm/1 1/2"  
RU 7592-05/35V  
RU 7592-05/35A

4 cm/1 1/2"  
RU 7592-05/40V  
RU 7592-05/40A

5 cm/2"  
RU 7592-05/50V  
RU 7592-05/50A



Coarctations-Klemmen  
 Coarctation clamps  
 Pinzas-clamps  
 para coarctación  
 Pinces-clamps  
 pour la coarctation  
 Pinze per  
 coartazione

**Rudolf**  
**DE BAKEY**



**Potts  
 (De Bakey)**

21,5 cm/8½"  
**RU 7600-21**  
**RU 7600-21 TI**



22,5 cm/9"  
**RU 7600-22**  
**RU 7600-22 TI**



26 cm/10¼"  
**RU 7600-26**



**Potts  
 (De Bakey)**

21 cm/8¼"  
**RU 7601-21**  
**RU 7601-21 TI**



22 cm/8¾"  
**RU 7601-22**  
**RU 7601-22 TI**



25 cm/9¾"  
**RU 7601-26**



Sicherungsschloß  
 Ratchet lock  
 Cierre de seguridad  
 Blocage de sécurité  
 Chiusura di sicurezza



**RU 7599-00**



**Potts**



21 cm/8¼"  
**RU 7602-21**



22 cm/8¾"  
**RU 7602-22**



Atrauma Cardiovascular-Klemmen  
 Atrauma Cardiovascular Forceps  
 Pinzas-clamps cardiovasculares  
 Pincas vasculaires atraumatiques  
 Pinze cardiovascolari atraumatiche



**Rudolf**  
 DE BAKEY

Anastomosen-Klemmen  
 Anastomosis clamps  
 Pinzas-clamps para anastomosis  
 Pincas-clamps pour l'anastomose  
 Pinze per anastomosi



Glover  
 (Potts)



21 cm/8¼"  
 RU 7603-21  
**RU 7603-21 TI**



21 cm/8¼"  
 RU 7604-21  
**RU 7604-21 TI**



25,5 cm/10"  
 RU 7604-24

Präparier- und Ligaturklemmen  
 Dissecting and ligature forceps  
 Pinzas para preparaciones y ligaduras  
 Pincas à préparation et ligature  
 Pinze per preparazioni e legature



De Bakey



20 cm/8"  
 RU 7605-20



22 cm/8¾"  
 RU 7605-24



De Bakey



19 cm/7½"  
 RU 7609-20  
**RU 7609-20 TI**



18 cm/7"  
 RU 7609-19  
**RU 7609-19 TI**

**TI = TITAN**



**Rudolf**  
 DE BAKEY



Leland-Jones

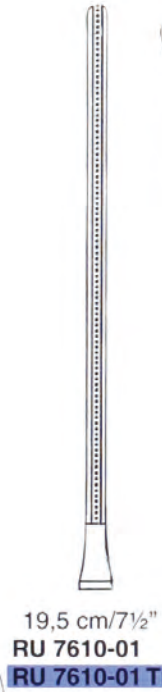

Leland-Jones  
 18 cm/7"  
 RU 7611-18  
 RU 7611-18 TI



De Bakey-Bainbridge

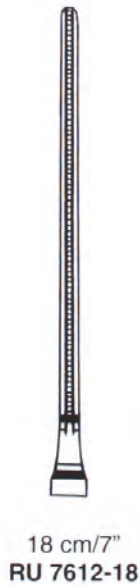
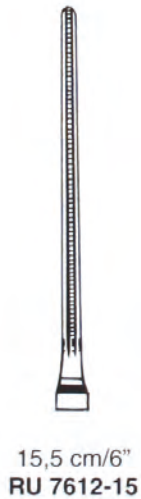

De Bakey  
 23 cm/9"  
 RU 7615-20

TI = TITAN



Atrauma Cardiovascular-Klemmen  
Atrauma Cardiovascular Forceps  
Atrauma Pinzas-clamps cardiovasculares  
Pincés vasculaires atraumatiques  
Pinze cardiovascolari atraumatiche



**Rudolf**  
DE BAKEY



Aorta-Aneurysmaklemmen  
Aortic aneurysm clamps  
Pinzas-clamps para  
aneurisma de aorta  
Pincés-clamps pour  
l'anévrisme de l'aorte  
Pinze per aneurisma  
dell'aorta

TI = TITAN



**rudolf**  
DE BAKEY

Aorta-Aneurysmaklemmen  
Aortic aneurysm clamps  
Pinzas-clamps para  
aneurisma de aorta  
Pinces-clamps pour  
l'anévrisme de l'aorte  
Pinze per aneurisma  
dell'aorta



**Wylie**  
24 cm/9½"  
RU 7619-01



**De Bakey**  
28 cm/11"  
RU 7620-28



31 cm/12¼"  
RU 7621-30



Atrauma Cardiovascular-Klemmen  
Atrauma Cardiovascular Forceps  
Atrauma Pinzas-clamps cardiovasculares  
Pincas vasculaires atraumatiques  
Pinze cardiovascolari atraumatiche



**rudolf**  
DE BAKEY

Aortaklemmen  
Aortic clamps  
Pinzas-clamps para aorta  
Pincas-clamps pour l'aorte  
Pinze per aorta



**Ochsner**  
26 cm/10¼"  
RU 7624-23



**Diethrich**  
21 cm/8¼"  
RU 7625-21



**Rudolf**  
DE BAKEY

Aurikelklemmen  
Auricle clamps  
Pinzas-clamps auriculares  
Pinces-clamps auriculaires  
Pinze per padiglione  
auricolare



Harken



25 cm/10"  
RU 7627-01



24 cm/9 1/2"  
RU 7627-02



24 cm/9 1/2"  
RU 7627-03



24 cm/9 1/2"  
RU 7627-04





Atrauma Cardiovascular-Klemmen  
Atrauma Cardiovascular Forceps  
Atrauma Pinzas-clamps cardiovasculares  
Pinces vasculaires atraumatiques  
Pinze cardiovascolari atraumatiche



**Rudolf**  
DE BAKEY

Bronchusklemmen  
Bronchus clamps  
Pinzas-clamps bronquiales  
Pinces-clamps à bronches  
Pinze per bronchi

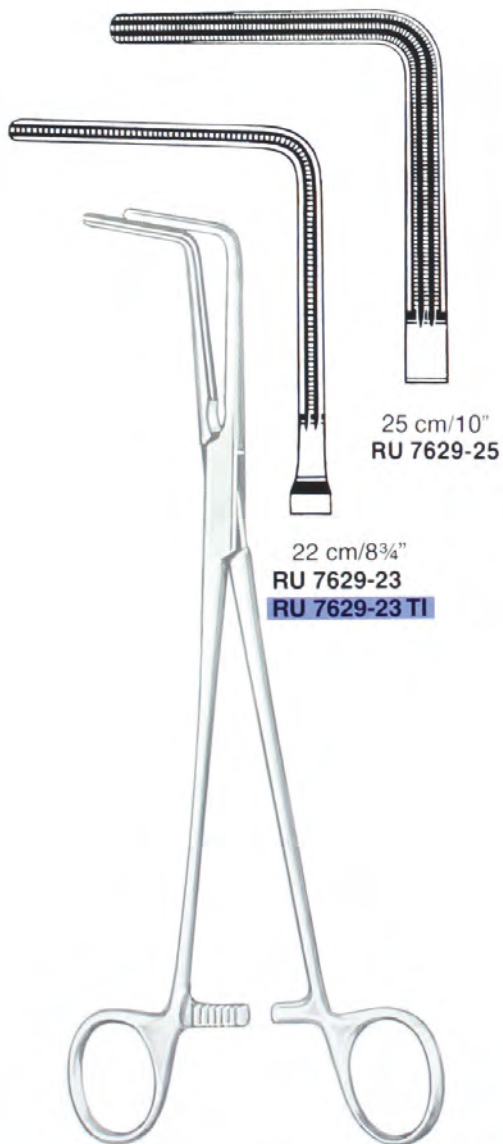

25 cm/10"  
RU 7629-25

22 cm/8¾"  
RU 7629-23  
RU 7629-23 TI

Lees



Lees  
24 cm/9½"  
RU 7630-25  
RU 7630-25 TI

TI = TITAN

**Atrauma Cardiovascular-Klemmen**  
**Atrauma Cardiovascular Forceps**  
**Atrauma Pinzas-clamps cardiovasculares**  
**Pinces vasculaires atraumatiques**  
**Pinze cardiovascolari atraumatiche**



**rudolf**  
**DE BAKEY**

Aortaklemme  
 Aortic clamps  
 Pinzas-clamps para aorta  
 Pinces-clamps pour l'aorte  
 Pinze per aorte

Ligaturklemmen  
 Ligature clamps  
 Pinzas-clamps para ligadura  
 Pinces-clamps pour la ligature  
 Pinze per legature

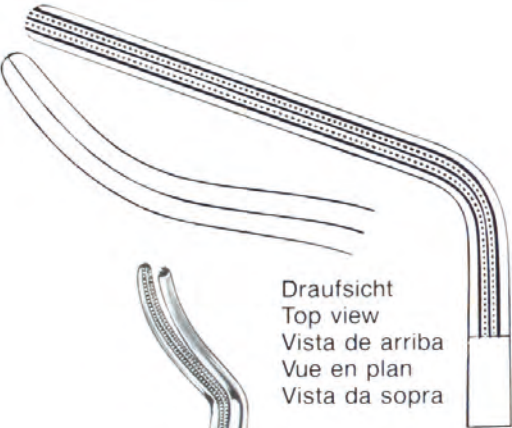

Draufsicht  
 Top view  
 Vista de arriba  
 Vue en plan  
 Vista da sopra



**De Bakey**  
 27 cm/10 1/2"  
 RU 7632-27



**De Bakey**  
 24 cm/9 1/2"  
 RU 7633-24



**De Bakey**  
 24 cm/9 1/2"  
 RU 7634-24



Atrauma Cardiovascular-Klemmen  
Atrauma Cardiovascular Forceps  
Atrauma Pinzas-clamps cardiovasculares  
Pincas vasculaires atraumatiques  
Pinze cardiovascolari atraumatiche



**Rudolf**  
DE BAKEY

Ligaturklemme,  
Aortaklemme  
Ligature clamps,  
Aortic clamps  
Pinzas-clamps para ligadura y aorta  
Pincas-clamps pour l'aorte et la ligature  
Pinze per aorta e legature



**De Bakey**  
27 cm/10½"  
RU 7636-26  
RU 7636-26 TI

**De Bakey-Semb**  
27 cm/10½"  
RU 7635-25

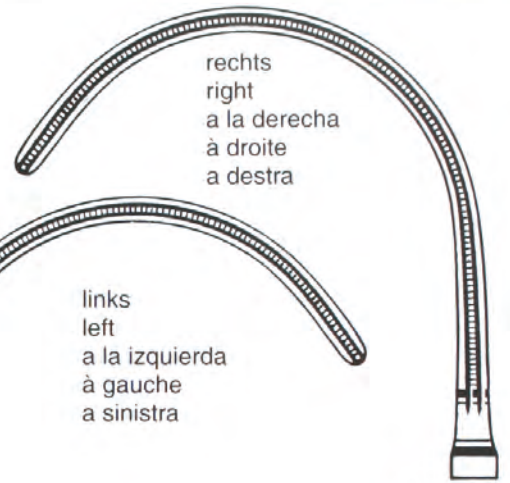

rechts  
right  
a la derecha  
à droite  
a destra

links  
left  
a la izquierda  
à gauche  
a sinistra

RU 7638-02

RU 7638-01

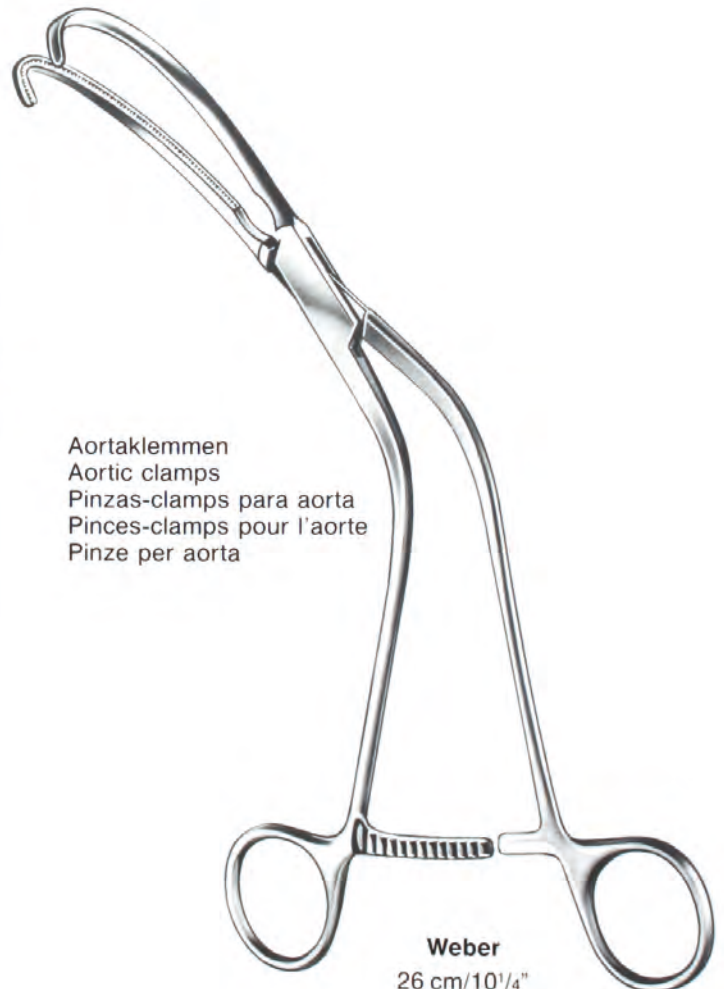

Aortaklemmen  
Aortic clamps  
Pinzas-clamps para aorta  
Pincas-clamps pour l'aorte  
Pinze per aorta

**Weber**  
26 cm/10¼"



**Satinsky-De Bakey**

**Rudolf**  
**DE BAKEY**

Tangentialklemmen  
 Tangential occlusion clamps  
 Pinzas-clamps para  
 oclusión tangencial  
 Pinces-clamps pour  
 l'occlusion tangentielle  
 Pinze per  
 occlusione tangenziale

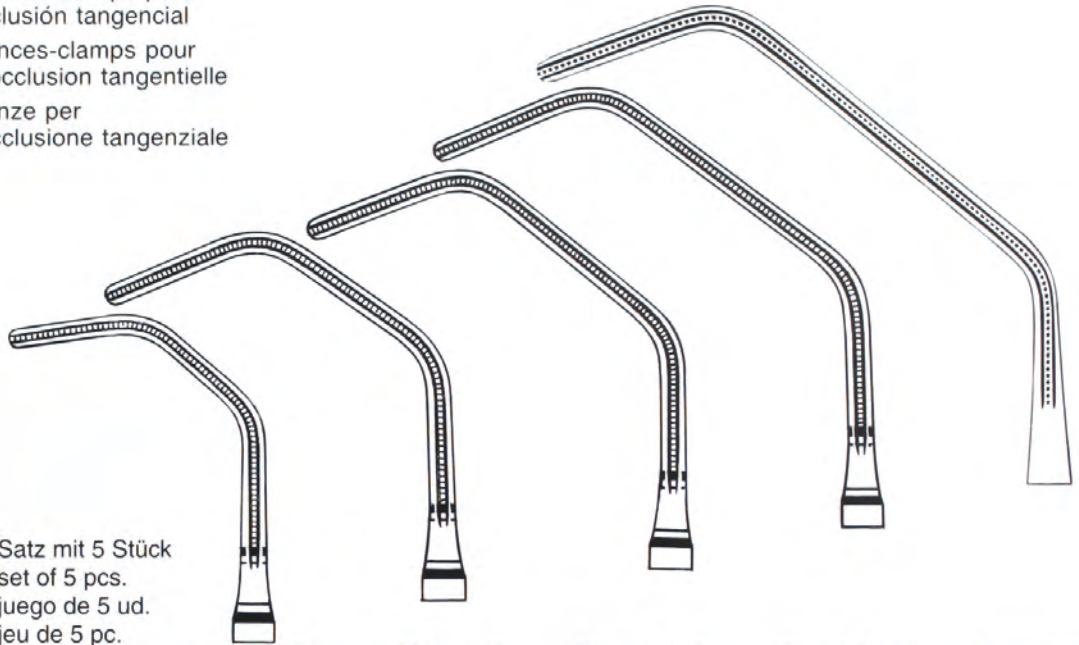

Satz mit 5 Stück  
 set of 5 pcs.  
 juego de 5 ud.  
 jeu de 5 pc.  
 set di

|               |               |               |               |               |               |               |               |               |               |               |
|---------------|---------------|---------------|---------------|---------------|---------------|---------------|---------------|---------------|---------------|---------------|
| RU 7640-00    | 20 cm/8"      | RU 7640-20    | 25 cm/10"     | RU 7640-25    | 26 cm/10¼"    | RU 7640-26    | 27 cm/10½"    | RU 7640-27    | 28 cm/11"     | RU 7640-28    |
| RU 7640-00 TI | RU 7640-20 TI | RU 7640-25 TI | RU 7640-26 TI | RU 7640-26 TI | RU 7640-27 TI | RU 7640-27 TI | RU 7640-28 TI | RU 7640-28 TI | RU 7640-28 TI | RU 7640-28 TI |



**Glover**

|            |             |
|------------|-------------|
| RU 7646-01 | 19,5 cm/7¾" |
| RU 7646-02 | 21 cm/8¼"   |

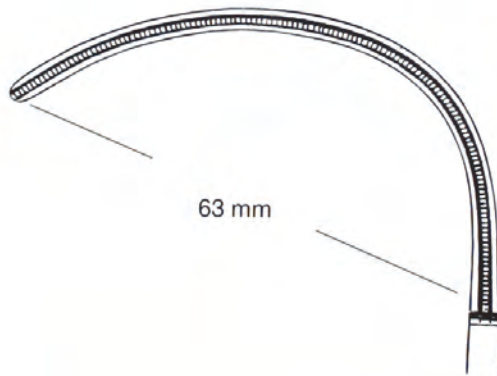

**RU 7646-02**

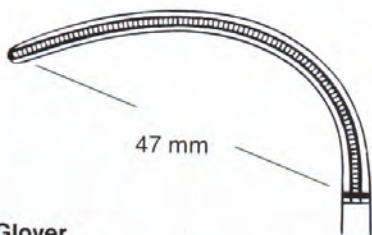

**RU 7646-01**

Anastomosenklemmen  
 Anastomosis clamps  
 Pinzas-clamps para anastomosis  
 Pinces-clamps pour l'anastomose  
 Pinze per anastomosi



Atrauma Cardiovascular-Klemmen  
Atrauma Cardiovascular Forceps  
Atrauma Pinzas-clamps cardiovasculares  
Pincers vasculaires atraumatiques  
Pinze cardiovascolari atraumatiche



**Rudolf**  
DE BAKKEY



**Lambert-Kay**  
21 cm/8<sup>1</sup>/<sub>4</sub>"

Aorta-Anastomosenklemmen  
Aortic anastomosis clamps  
Pinzas-clamps para anastomosis  
Pincers-clamps pour l'anastomose de l'aorte  
Pinze anastomosi aorta



**RU 7648-21**  
**RU 7648-21 TI**

**RU 7647-21**  
**RU 7647-21 TI**



**De Bakey**  
17 cm/6<sup>3</sup>/<sub>4</sub>"  
**RU 7649-17**



**Beck**  
16 cm/6<sup>1</sup>/<sub>4</sub>"  
**RU 7650-17**  
**RU 7650-17 TI**

TI = TITAN

**Atrauma Cardiovascular-Klemmen**  
**Atrauma Cardiovascular Forceps**  
**Atrauma Pinzas-clamps cardiovasculares**  
**Pinces vasculaires atraumatiques**  
**Pinze cardiovascolari atraumatiche**



**rudolf**  
**DE BAKEY**



**De Bakey**  
 16 cm/6¼"  
**RU 7651-16**  
**RU 7651-16 TI**

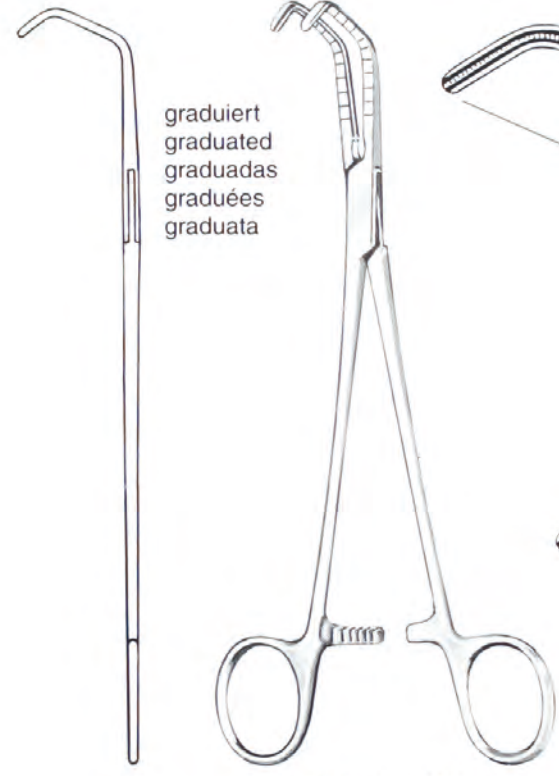

graduiert  
 graduated  
 graduadas  
 graduées  
 graduata

**De Bakey-Beck**  
**RU 7653-01** 20,5 cm/8"  
**RU 7653-02** 21 cm/8¼"

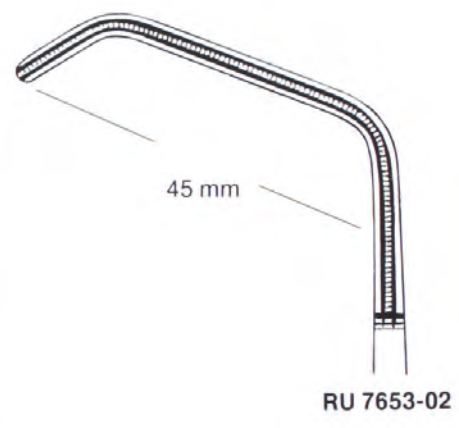

45 mm

**RU 7653-02**

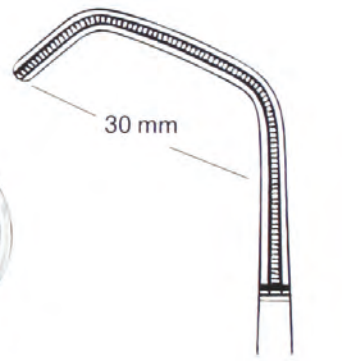

30 mm

**RU 7653-01**

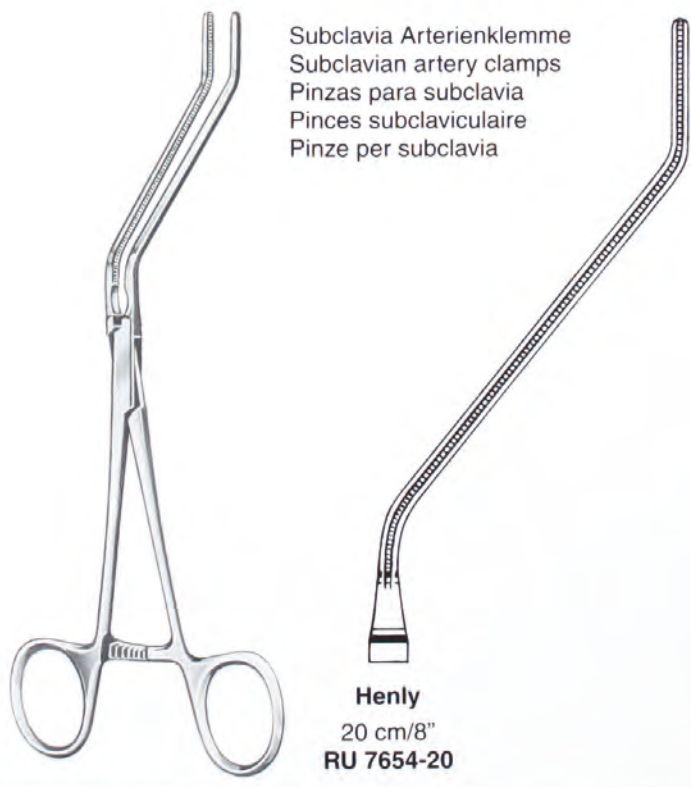

Subclavia Arterienklemme  
 Subclavian artery clamps  
 Pinzas para subclavia  
 Pinces subclaviculaire  
 Pinze per subclavia

**Henly**  
 20 cm/8"  
**RU 7654-20**

**TI = TITAN**



Atrauma Cardiovascular-Klemmen  
Atrauma Cardiovascular Forceps  
Atrauma Pinzas-clamps cardiovasculares  
Pincers vasculaires atraumatiques  
Pinze cardiovascolari atraumatiche



RU 7657-00



15°  
RU 7657-15



30°  
RU 7657-30



45°  
RU 7657-45



90°  
RU 7657-90

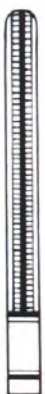

RU 7658-00

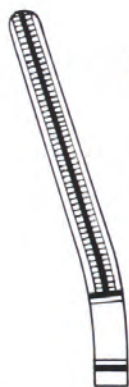

15°  
RU 7658-15

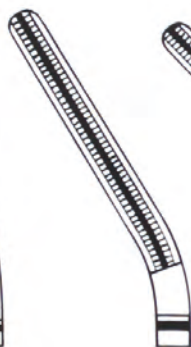

30°  
RU 7658-30

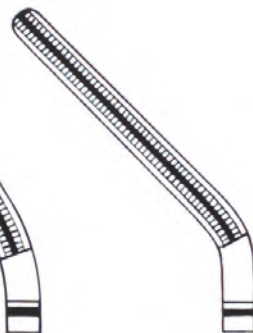

45°  
RU 7658-45

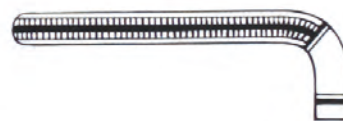

90°  
RU 7658-90



**Dardik**

13 cm – 17 cm/5" – 6¾"



**Rudolf**  
 DE BAKEY

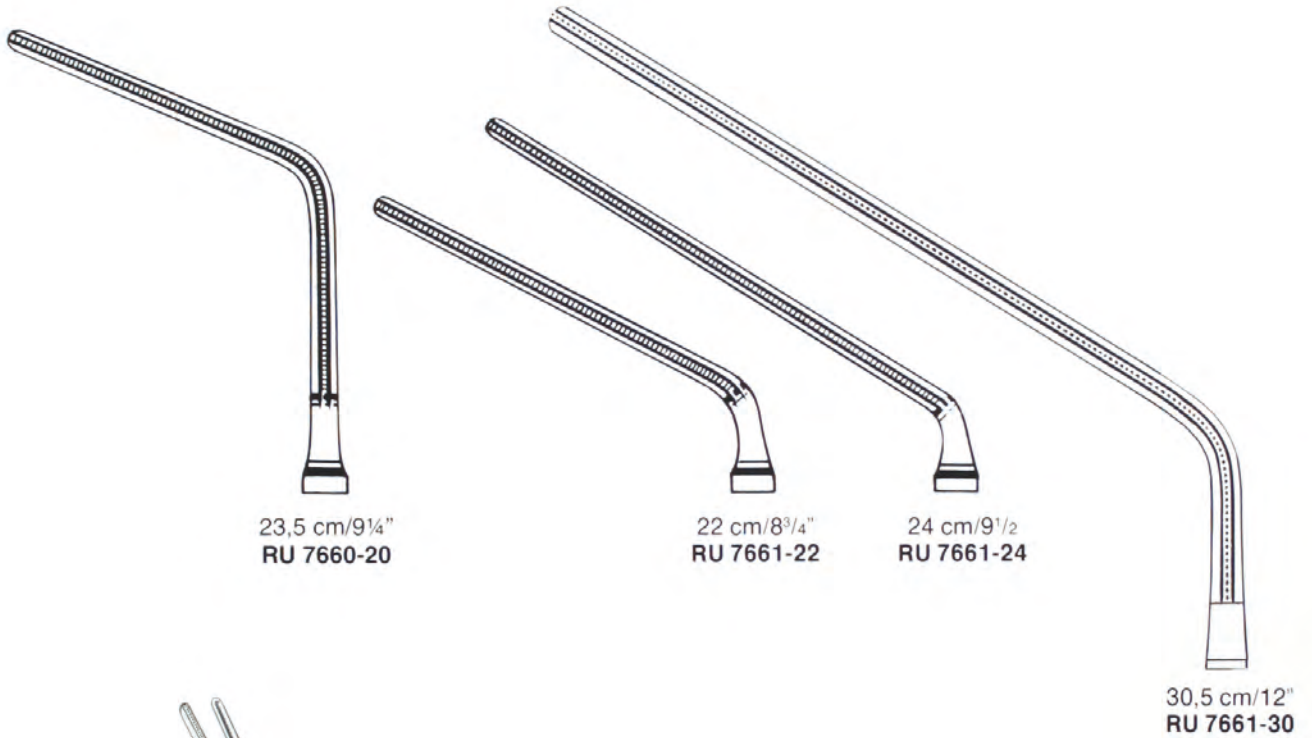

Mehrzweckklemmen  
 Multi purpose clamps  
 Pinzas-clamps para  
 usos varios  
 Pincers-clamps à usage  
 multiple  
 Pinze per vari usi



De Bakey

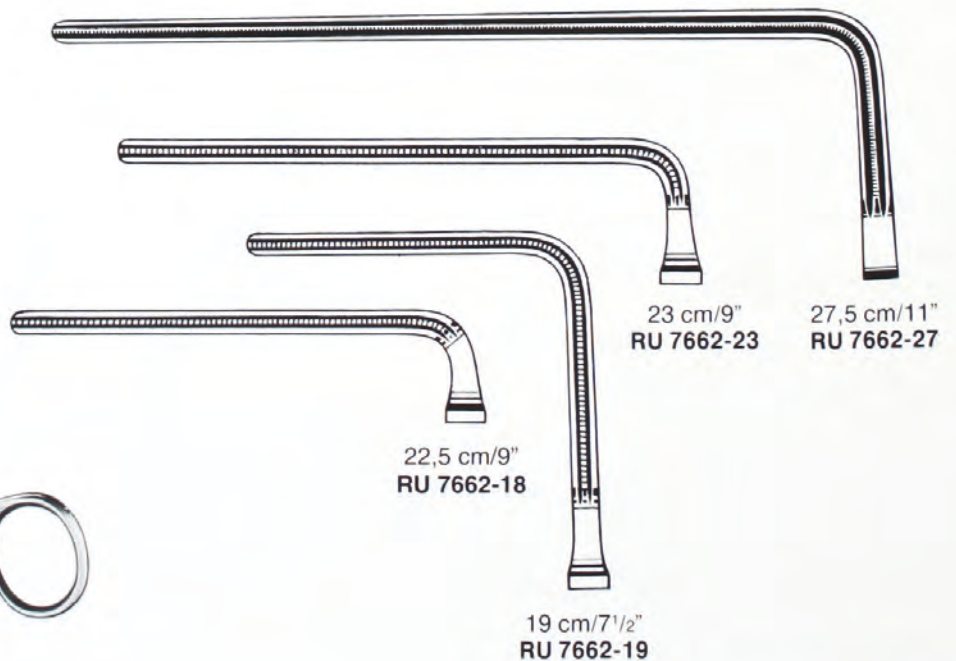





Atrauma Cardiovascular-Klemmen  
Atrauma Cardiovascular Forceps  
Atrauma Pinzas-clamps cardiovasculares  
Pincas vasculaires atraumatiques  
Pinze cardiovascolari atraumatiche



**Rudolf**  
DE BAKEY

Aorta-Anastomosenklemmen  
Aortic anastomosis clamps  
Pinzas-clamps para anastomosis de aorta  
Pincas-clamps pour l'anastomose de l'aorte  
Pinze anastomosi aorta



**Wertheim**  
24 cm/9½"



**Dick**

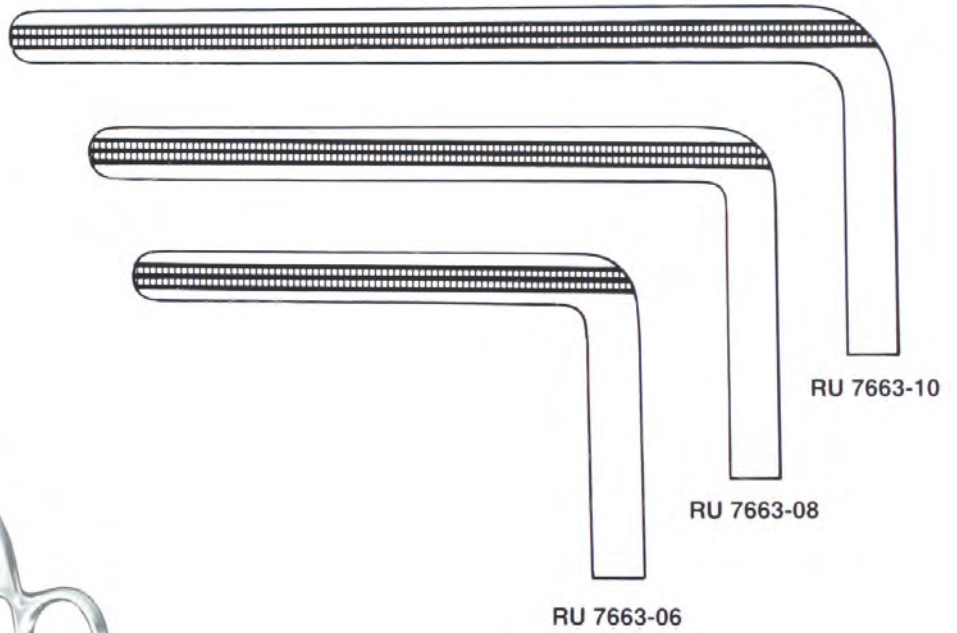



**Rudolf**  
 DE BAKEY

Aorta-Anastomosenklemmen  
 Aortic anastomosis clamps  
 Pinzas-clamps para anastomosis de aorta  
 Pincas-clamps pour l'anastomose de l'aorte  
 Pinze anastomosi aorta



**Morris-De Bakey**



26 cm/10¼"  
 RU 7664-23

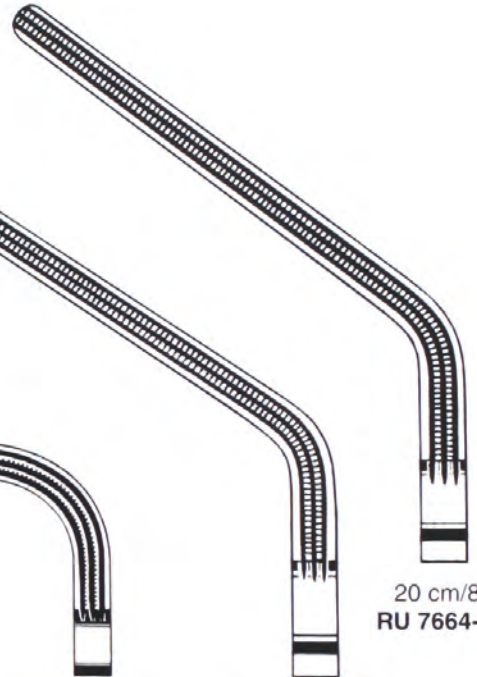

26,5 cm/10½"  
 RU 7664-25

20 cm/8"  
 RU 7664-20



**Glover**  
 24,5 cm/9¾"  
 RU 7665-24





**Atrauma Cardiovascular-Klemmen**  
**Atrauma Cardiovascular Forceps**  
**Atrauma Pinzas-clamps cardiovasculares**  
**Pinces vasculaires atraumatiques**  
**Pinze cardiovascolari atraumatiche**



**Rudolf**  
**DE BAKEY**

Aorta-Aneurysmenklemmen  
 Aorta aneurysm clamps  
 Pinzas-clamps para  
 aneurisma de aorta  
 Pinces-clamps pour  
 l'anévrisme de l'aorte  
 Pinze per aneurisma dell' aorta



**De Bakey-Bahnson**

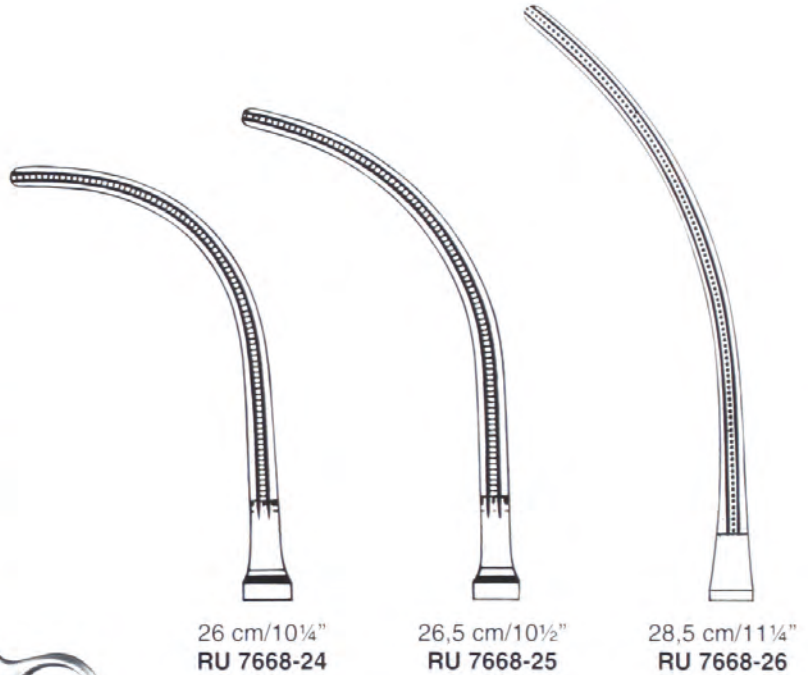

26 cm/10¼"  
 RU 7668-24

26,5 cm/10½"  
 RU 7668-25

28,5 cm/11¼"  
 RU 7668-26

Coarctations-Klemmen  
 Coarctation clamps  
 Pinzas-clamps para coarctación  
 Pinces-clamps pour la coarctation  
 Pinze per coartazione

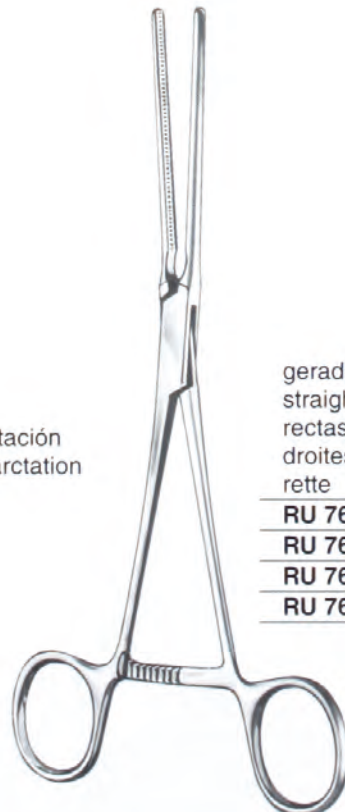

gerade  
 straight  
 rectas  
 droites  
 rette

gebogen  
 curved  
 curvas  
 courbes  
 curve

|                   |              |              |                   |
|-------------------|--------------|--------------|-------------------|
| <b>RU 7670-21</b> | 20 cm/8"     | 19,5 cm/7¾"  | <b>RU 7671-21</b> |
| <b>RU 7670-23</b> | 23 cm/9"     | 22,5 cm/8¾"  | <b>RU 7671-23</b> |
| <b>RU 7670-27</b> | 26 cm/10¼"   | 25,5 cm/10¼" | <b>RU 7671-27</b> |
| <b>RU 7670-31</b> | 31,5 cm/12½" | 31 cm/12¼"   | <b>RU 7671-31</b> |



**Rudolf**  
 DE BAKEY



RU 7680-12 RU 7681-12

**Mosquito**  
 12 cm/4<sup>3</sup>/<sub>4</sub>"

Atrauma-Arterienklemmen  
 Atrauma hemostatic forceps  
 Pinzas hemostáticas atrauma  
 Pinces hémostatiques atraumatiques  
 Pinze emostatiche atraumatiche



**De Bakey-Pean**

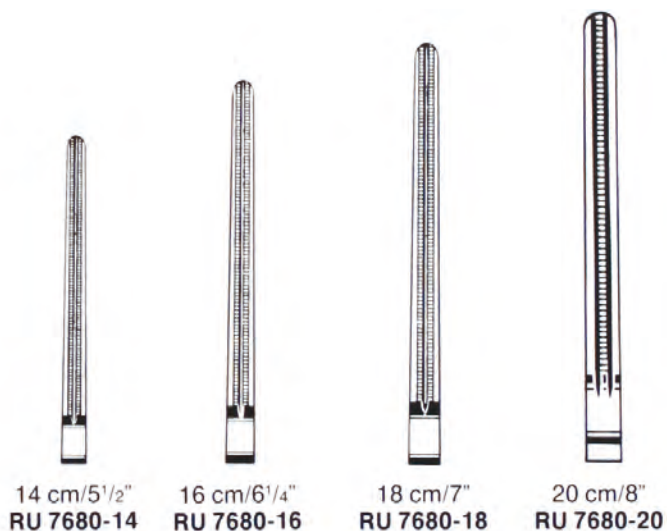

14 cm/5<sup>1</sup>/<sub>2</sub>" RU 7680-14  
 16 cm/6<sup>1</sup>/<sub>4</sub>" RU 7680-16  
 18 cm/7" RU 7680-18  
 20 cm/8" RU 7680-20



14 cm/5<sup>1</sup>/<sub>2</sub>" RU 7681-14  
 16 cm/6<sup>1</sup>/<sub>4</sub>" RU 7681-16  
 17 cm/6<sup>3</sup>/<sub>4</sub>" RU 7681-18  
 20 cm/8" RU 7681-20



**Atrauma Cardiovascular-Klemmen**  
**Atrauma Cardiovascular Forceps**  
**Atrauma Pinzas-clamps cardiovasculares**  
**Pinces vasculaires atraumatiques**  
**Pinze cardiovascolari atraumatiche**



**Rudolf**  
**DE BAKEY**

Mehrweckklemmen  
 Multi purpose clamps  
 Pinzas-clamps para usos varios  
 Pinces-clamps à usage multiple  
 Pinze per vari usi



**De Bakey-Rankin**

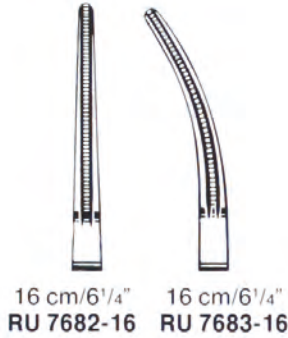

16 cm/6<sup>1</sup>/<sub>4</sub>" RU 7682-16    16 cm/6<sup>1</sup>/<sub>4</sub>" RU 7683-16



**De Bakey**

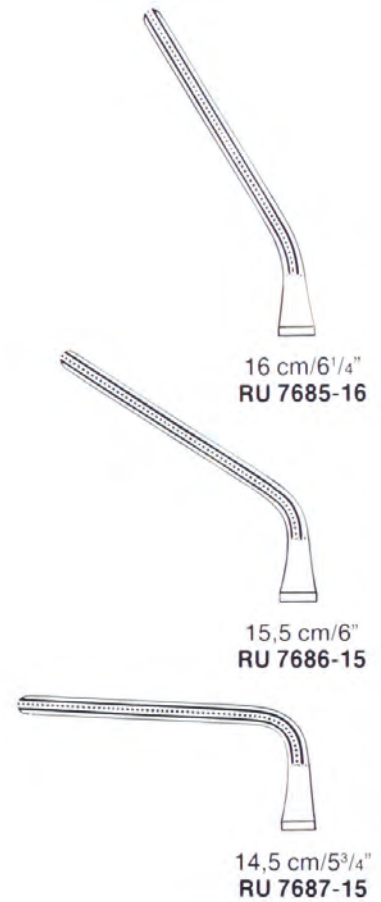

16 cm/6<sup>1</sup>/<sub>4</sub>"  
 RU 7685-16

15,5 cm/6"  
 RU 7686-15

14,5 cm/5<sup>3</sup>/<sub>4</sub>"  
 RU 7687-15



**De Bakey**  
 17 cm/6<sup>3</sup>/<sub>4</sub>"  
 RU 7688-17



RU 7689-17



RU 7690-17



RU 7691-17

Ligaturklemmen  
 Ligature clamps  
 Pinzas-clamps para ligadura  
 Pinces-clamps pour la ligature  
 Pinze per legature

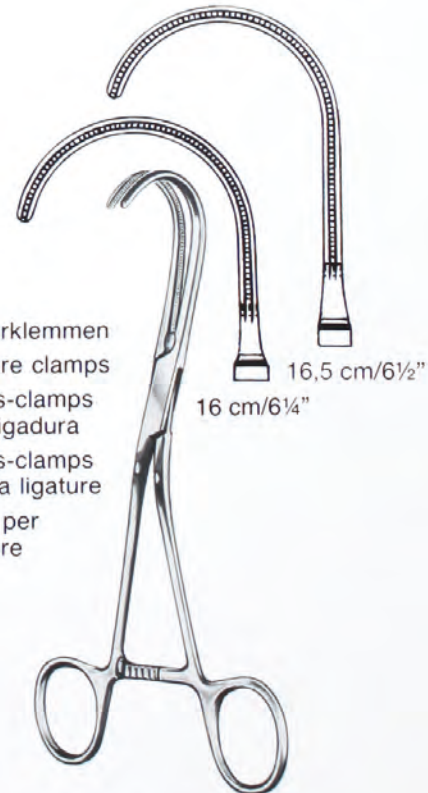

16,5 cm/6<sup>1</sup>/<sub>2</sub>"  
 16 cm/6<sup>1</sup>/<sub>4</sub>"

16 cm/6<sup>1</sup>/<sub>4</sub>" RU 7692-16  
 16,5 cm/6<sup>1</sup>/<sub>2</sub>" RU 7692-17



**Rudolf**  
**DE BAKEY**

Peripheral-Gefäßklemmen  
 Peripheral vessel clamps  
 Pinzas-clamps periféricas  
 Pinces-clamps périphériques  
 Pinze periferiche



RU 7694-01  
**RU 7694-01 TI**

**Derra-De Bakey**  
 17 cm/6<sup>3</sup>/<sub>4</sub>"

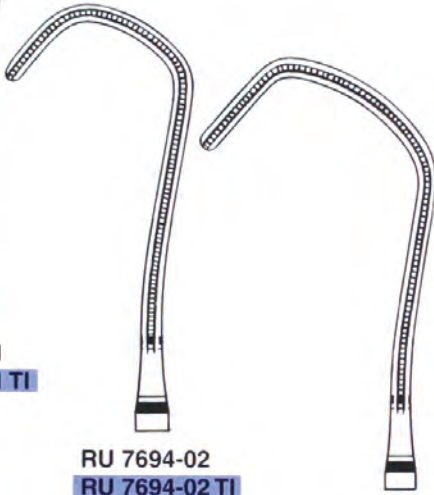

RU 7694-02  
**RU 7694-02 TI**

RU 7694-03  
**RU 7694-03 TI**

Anastomosenklemmen  
 Anastomosis clamps  
 Pinzas-clamps para anastomosis  
 Pinces-clamps pour l'anastomose  
 Pinze per anastomosi

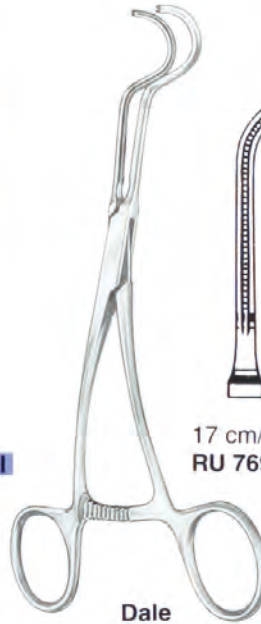

17 cm/6<sup>3</sup>/<sub>4</sub>"  
**RU 7695-41**

**Dale**

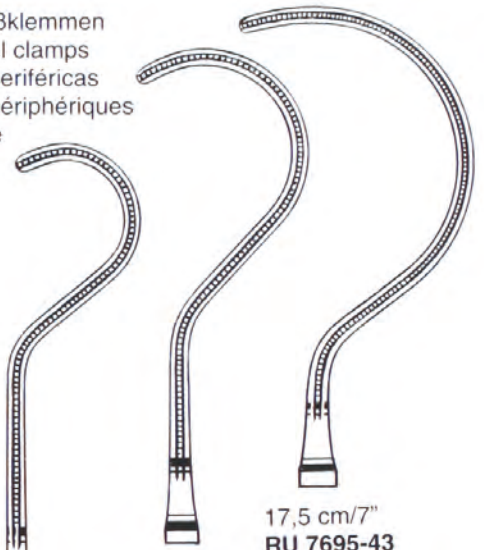

17,5 cm/7"  
**RU 7695-42**

17,5 cm/7"  
**RU 7695-43**

Profundaklemmen  
 Profunda clamps  
 Pinzas-clamps profundales  
 Pinces-clamps profundales  
 Pinze per profondità



14,5 cm/5<sup>1</sup>/<sub>2</sub>"  
**RU 7698-14**

**Gregory**

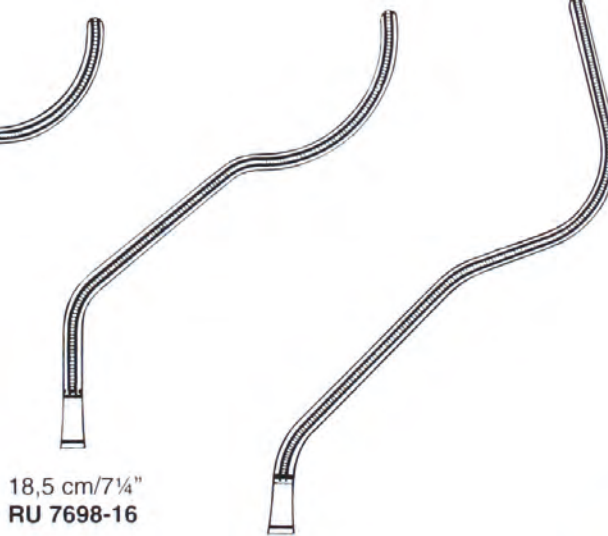

18,5 cm/7<sup>1</sup>/<sub>4</sub>"  
**RU 7698-16**

19,5 cm/7<sup>3</sup>/<sub>4</sub>"  
**RU 7698-18**



15 cm/6"  
**RU 7699-15**  
**RU 7699-15 TI**

**Subramanian-Miniature**

**TI = TITAN**



Atrauma Cardiovascular-Klemmen  
Atrauma Cardiovascular Forceps  
Atrauma Pinzas-clamps cardiovasculares  
Pinces vasculaires atraumatiques  
Pinze cardiovascolari atraumatiche



**Rudolf**  
DE BAKEY



**De Bakey**  
13 cm/5"  
RU 7701-12



12,5 cm/5"  
RU 7702-11



13 cm/5"  
RU 7703-12



12,5 cm/5"  
RU 7704-13



10 cm/4"  
RU 7705-10



**rudolf**  
 DE BAKEY



RU 7706-01  
 RU 7706-01 TI



RU 7706-03  
 RU 7706-03 TI



RU 7706-05  
 RU 7706-05 TI

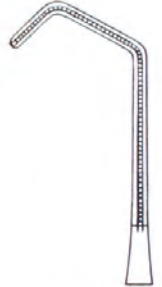

RU 7706-08  
 RU 7706-08 TI



RU 7706-09  
 RU 7706-09 TI



RU 7706-10  
 RU 7706-10 TI



RU 7706-13  
 RU 7706-13 TI



RU 7706-15  
 RU 7706-15 TI



De Bakey-Castaneda  
 12 cm/4¾"

TI = TITAN





Frühgeborenen Mikro-Gefäßklemmen  
Micro Vascular Clamps for Prematures  
Micro pinzas-clamps vasculares para niños prematuros  
Clamps micro-vasculaires pour des prématurés  
Pinze micro vascolari atraumatiche per prematuri



**Rudolf**  
DE BAKEY



10,5 cm/4¼"  
RU 7708-50  
RU 7708-50 TI



10,5 cm/4¼"  
RU 7708-52  
RU 7708-52 TI



12,0 cm/4¾"  
RU 7708-54  
RU 7708-54 TI



10,5 cm/4¼"  
RU 7708-56  
RU 7708-56 TI



10,5 cm/4¼"  
RU 7708-58  
RU 7708-58 TI



10,5 cm/4¼"  
RU 7708-60  
RU 7708-60 TI

TI = TITAN



**Rudolf**  
 DE BAKEY



komplett  
 complete  
 completo  
 complet  
 completo

RU 7709-00

Inhalt

- 1 x RU 6059-63 Micro-Ryder Nadelhalter
- 1 x RU 1316-14 Metzenbaum-Fino Schere
- 1 x RU 3328-14 Baby-Mixer Klemme
- 1 x **RU 7530-00 TI** Neonatal Titan Sternensperrer
- 1 x RU 7702-11 De Bakey Atrauma Klemme
- 1 x RU 7701-12 De Bakey Atrauma Klemme
- 1 x RU 7704-13 De Bakey Atrauma Klemme
- 1 x RU 7706-01 De Bakey-Castaneda Klemme
- 1 x RU 7706-08 De Bakey-Castaneda Klemme
- 1 x **RU 7580-10/15 TI** De Bakey Titan Pinzette
- 1 x RU 8904-07/01 Etui

Content

- 1 x RU 6059-63 needle holder Micro-Ryder
- 1 x RU 1316-14 scissors Metzenbaum-Fino
- 1 x RU 3328-14 forceps Baby-Mixer
- 1 x **RU 7530-00 TI** sternum spreader for newborns, titanium
- 1 x RU 7702-11 atraumatic clamps De Bakey
- 1 x RU 7701-12 atraumatic clamps De Bakey
- 1 x RU 7704-13 atraumatic clamps De Bakey
- 1 x RU 7706-01 clamps De Bakey-Castaneda
- 1 x RU 7706-08 clamps De Bakey-Castaneda
- 1 x **RU 7580-10/15 TI** dissecting forceps De Bakey, titanium
- 1 x RU 8904-07/01 case

Contenido

- 1 x RU 6059-63 porta-agujas Micro-Ryder
- 1 x RU 1316-14 tijera Metzenbaum-Fino
- 1 x RU 3328-14 pinza Baby-Mixer
- 1 x **RU 7530-00 TI** separador de esternón para recién nacidos de titanio
- 1 x RU 7702-11 atrauma pinza-clamp De Bakey
- 1 x RU 7701-12 atrauma pinza-clamp De Bakey
- 1 x RU 7704-13 atrauma pinza-clamp De Bakey
- 1 x RU 7706-01 pinza-clamp De Bakey-Castaneda
- 1 x RU 7706-08 pinza clamp De Bakey-Castaneda
- 1 x **RU 7580-10/15 TI** pinza de disección De Bakey, de titanio
- 1 x RU 8904-07/01 estuche

Contenu

- 1 x RU 6059-63 porte-aiguille Micro-Ryder
- 1 x RU 1316-14 ciseaux Metzenbaum-Fino
- 1 x RU 3328-14 pince Baby-Mixer
- 1 x **RU 7530-00 TI** écarteur à sternum néonatal, en titane
- 1 x RU 7702-11 pinces-clamps atraumatiques De Bakey
- 1 x RU 7701-12 pinces-clamps atraumatiques De Bakey
- 1 x RU 7704-13 pinces-clamps atraumatiques De Bakey
- 1 x RU 7706-01 pinces-clamps De Bakey-Castaneda
- 1 x RU 7706-08 pinces-clamps De Bakey-Castaneda
- 1 x **RU 7580-10/15 TI** pince à disséquer De Bakey, en titane
- 1 x RU 8904-07/01 boîte

Contenuto

- 1 x RU 6059-63 Portaghi Micro-Ryder
- 1 x RU 1316-14 Forbici Metzenbaum-Fino
- 1 x RU 3328-14 Pinze Baby-Mixer
- 1 x **RU 7530-00 TI** Divaricatore per sterno per neonati, titanio
- 1 x RU 7702-11 Pinze cardiovascolari atraumatiche, titanio De Bakey
- 1 x RU 7701-12 Pinze cardiovascolari atraumatiche, titanio De Bakey
- 1 x RU 7704-13 Pinze cardiovascolari atraumatiche, titanio De Bakey
- 1 x RU 7706-01 Pinze cardiovascolari atraumatiche, titanio De Bakey
- 1 x RU 7706-08 Pinze cardiovascolari atraumatiche, titanio De Bakey
- 1 x **RU 7580-10/15 TI** Pinze De Bakey atraumatiche titanio
- 1 x RU 8904-07/01 Scatole

**TI = TITAN**



**Atrauma Cardiovascular-Klemmen**  
**Atrauma Cardiovascular Forceps**  
**Atrauma Pinzas-clamps cardiovasculares**  
**Pinces vasculaires atraumatiques**  
**Pinze cardiovascolari atraumatiche**



**Rudolf**  
**COOLEY**

Karotisklemmen  
 Carotid clamps  
 Pinzas-clamps  
 para carotis  
 Pinces-clamps  
 pour la carotide  
 Pinze per la  
 carotide



**Javid**  
 15,5 cm/6"  
**RU 7710-18**



**Javid**  
 18 cm/7"  
**RU 7710-19**



**Cooley**

| Charrière<br>(French) | Länge<br>length<br>largo<br>longueur<br>lunghezza<br>cm |                   |
|-----------------------|---|-------------------|
| 24                    | 16  | <b>RU 7711-24</b> |
| 26                    | 16  | <b>RU 7711-26</b> |
| 28                    | 19  | <b>RU 7711-28</b> |
| 30                    | 19  | <b>RU 7711-30</b> |
| 32                    | 19  | <b>RU 7711-32</b> |
| 36                    | 19  | <b>RU 7711-36</b> |



**Rudolf**  
 COOLEY

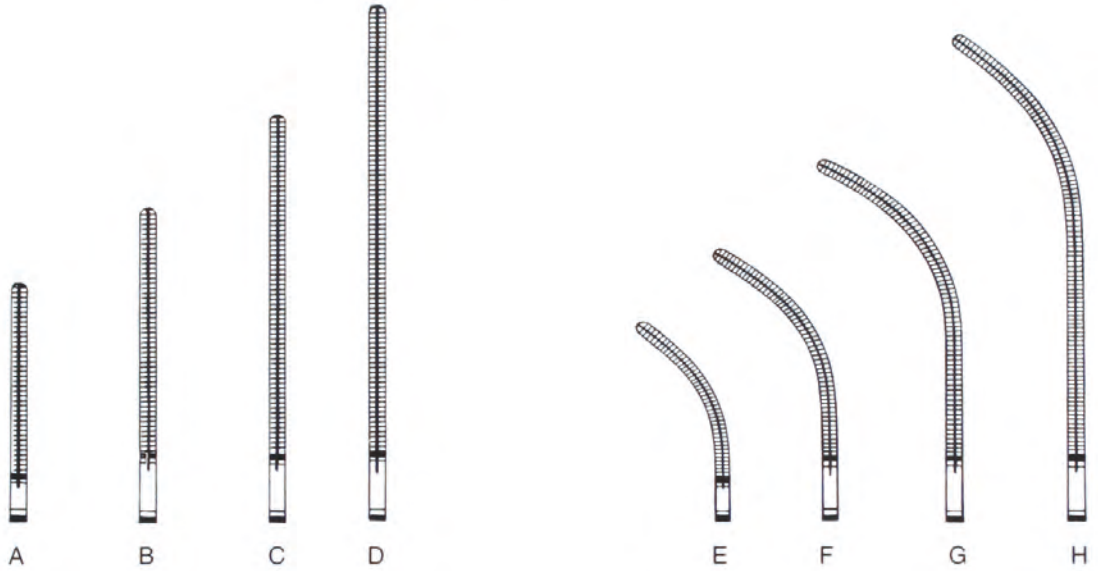

Cooley  
 Glover

| Fig. | Gesamtlänge<br>overall length<br>largo total<br>longueur totale<br>lunghezza totale<br>(mm) | Maullänge<br>jaw length<br>largo de boca<br>longueur du mos<br>lunghezza del<br>morso (mm) | Artikel-Nr.<br>Article No.<br>Referencia<br>Référence<br>No. art. |
|------|---|--|---|
| A    | 70  | 20   | RU 7715-40  |
| B    | 80  | 30   | RU 7715-41  |
| C    | 95  | 43   | RU 7715-42  |
| D    | 115   | 56   | RU 7715-43  |

| Fig. | Gesamtlänge<br>overall length<br>largo total<br>longueur totale<br>lunghezza totale<br>(mm) | Maullänge<br>jaw length<br>largo de boca<br>longueur du mos<br>lunghezza del<br>morso (mm) | Artikel-Nr.<br>Article No.<br>Referencia<br>Référence<br>No. art. |
|------|---|--|---|
| E    | 65  | 20   | RU 7715-45  |
| F    | 75  | 30   | RU 7715-46  |
| G    | 85  | 43   | RU 7715-47  |
| H    | 105   | 56   | RU 7715-48  |

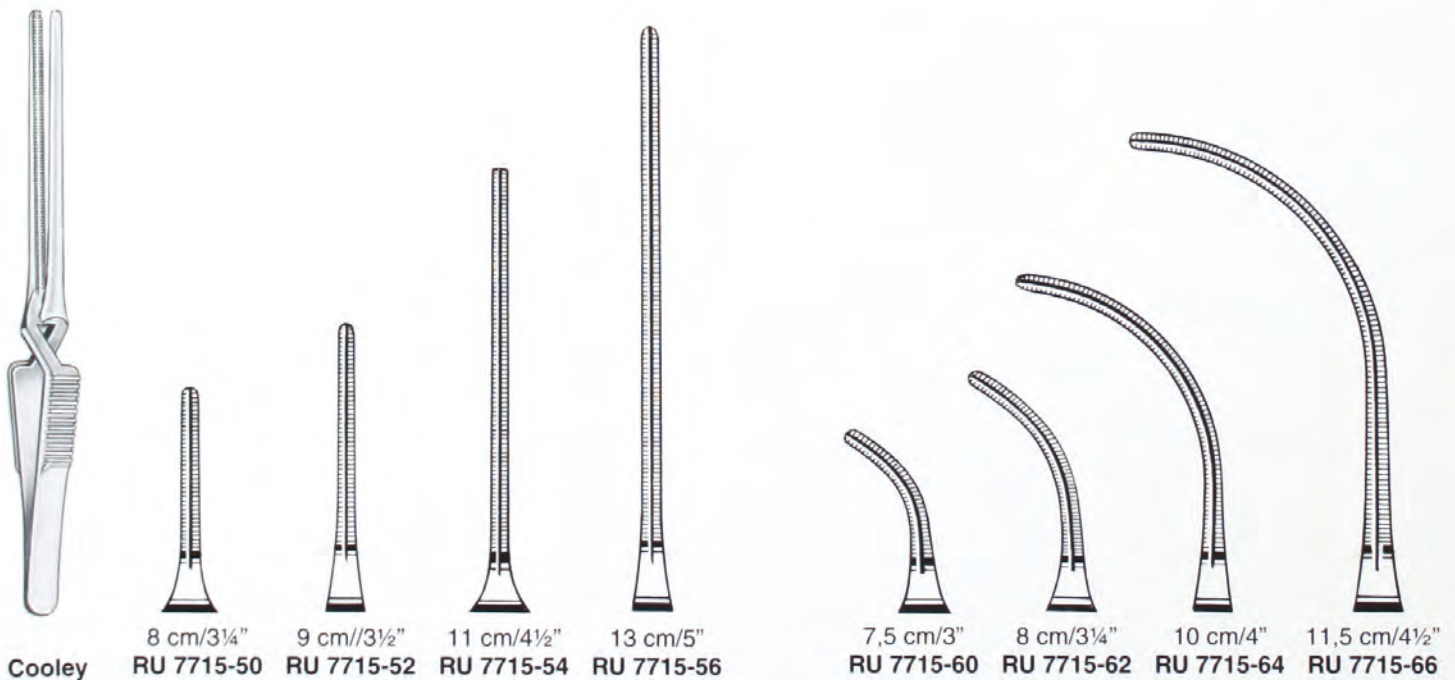

Cooley  
 8 cm/3¼" RU 7715-50  
 9 cm/3½" RU 7715-52  
 11 cm/4½" RU 7715-54  
 13 cm/5" RU 7715-56  
 7,5 cm/3" RU 7715-60  
 8 cm/3¼" RU 7715-62  
 10 cm/4" RU 7715-64  
 11,5 cm/4½" RU 7715-66



Atrauma Cardiovascular-Klemmen  
Atrauma Cardiovascular Forceps  
Atrauma Pinzas-clamps cardiovasculares  
Pinces vasculaires atraumatiques  
Pinze cardiovascolari atraumatiche



**rudolf**  
COOLEY

Coarctationsklemmen  
Coarctation clamps  
Pinzas-clamps para coarctación  
Pinces-clamps pour la coarctation  
Pinze per coartazione



Cooley  
17 cm/6 $\frac{3}{4}$ "  
RU 7721-17  
RU 7721-17 TI



17 cm/6 $\frac{3}{4}$ "  
RU 7722-17  
RU 7722-17 TI

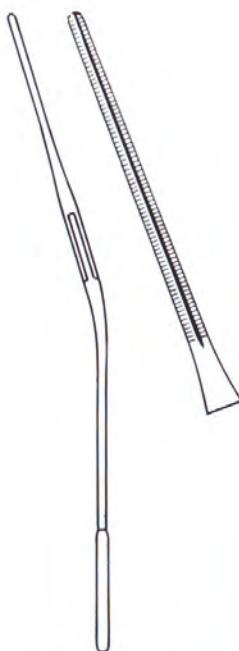

17 cm/6 $\frac{3}{4}$ "  
RU 7723-17  
RU 7723-17 TI

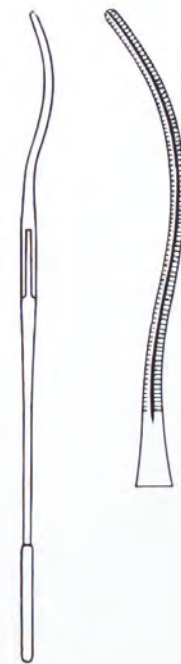

17,5 cm/7"  
RU 7724-17  
RU 7724-17 TI

TI = TITAN

**Rudolf**  
 COOLEY

Mehrzweckklemmen  
 Multi purpose clamps  
 Pinzas-clamps para usos varios  
 Pincers-clamps à usage multiple  
 Pinze per vari usi



Cooley



18 cm/7"  
 RU 7726-18  
 RU 7726-18 TI



20 cm/8"  
 RU 7726-20  
 RU 7726-20 TI



27 cm/10½"  
 RU 7726-27  
 RU 7726-27 TI



Cooley

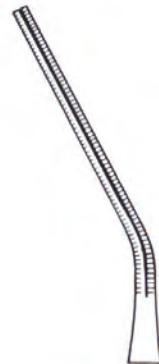

16,5 cm/6½"  
 RU 7728-17  
 RU 7728-17 TI



15,5 cm/6"  
 RU 7729-15  
 RU 7729-15 TI



13,5 cm/5¼"  
 RU 7730-15  
 RU 7730-15 TI

TI = TITAN



Atrauma Cardiovascular-Klemmen  
Atrauma Cardiovascular Forceps  
Atrauma Pinzas-clamps cardiovasculares  
Pinces vasculaires atraumatiques  
Pinze cardiovascolari atraumatiche



**Rudolf**  
COOLEY



**Cooley**  
26,5 cm/10 $\frac{1}{4}$ "  
RU 7731-01



**Cooley**

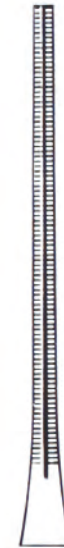

21,5 cm/8 $\frac{1}{2}$ "  
RU 7731-04

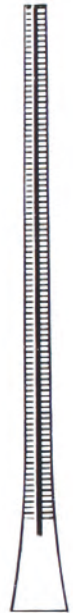

25 cm/10"  
RU 7731-05



**Cooley**  
16 cm/6 $\frac{1}{4}$ "  
RU 7734-17

Anastomosenklemmen  
 Anastomosis clamps  
 Pinzas-clamps para anastomosis  
 Pinces-clamps pour l'anastomose de l'aorte  
 Pinze per anastomosi

**Rudolf**  
**COOLEY**



**Cooley**  
 16,5 cm/6 1/2"

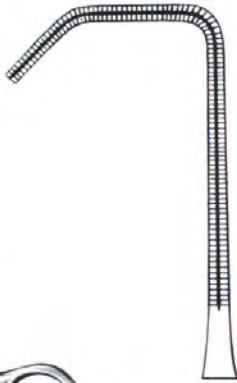

**RU 7735-16**



**RU 7736-16**



**RU 7737-17**



**RU 7738-17**



**Cooley**

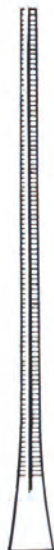

**22,5 cm/8 3/4"**  
**RU 7739-01**

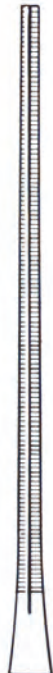

**24,5 cm/9 3/4"**  
**RU 7739-03**



**Cooley**



**22 cm/8 3/4"**  
**RU 7739-05**



**24 cm/9 1/2"**  
**RU 7739-07**





Atrauma Cardiovascular-Klemmen  
Atrauma Cardiovascular Forceps  
Atrauma Pinzas-clamps cardiovasculares  
Pincers vasculaires atraumatiques  
Pinze cardiovascolari atraumatiche



**rudolf**  
COOLEY

Cooley  
22 cm/8 $\frac{3}{4}$ "  
RU 7739-22



Cooley  
25,5 cm/10 $\frac{1}{4}$ "  
RU 7739-26



Cooley  
16 cm/6 $\frac{1}{4}$ "  
RU 7740-16



Beck  
17 cm/6 $\frac{3}{4}$ "  
RU 7741-17

**Rudolf**  
**COOLEY**



Cooley

Tangentialklemmen  
 Tangential occlusion clamps  
 Pinzas-clamps para oclusión tangencial  
 Pinces-clamps pour l'occlusion tangentielle  
 Pinze per occlusione tangenziale

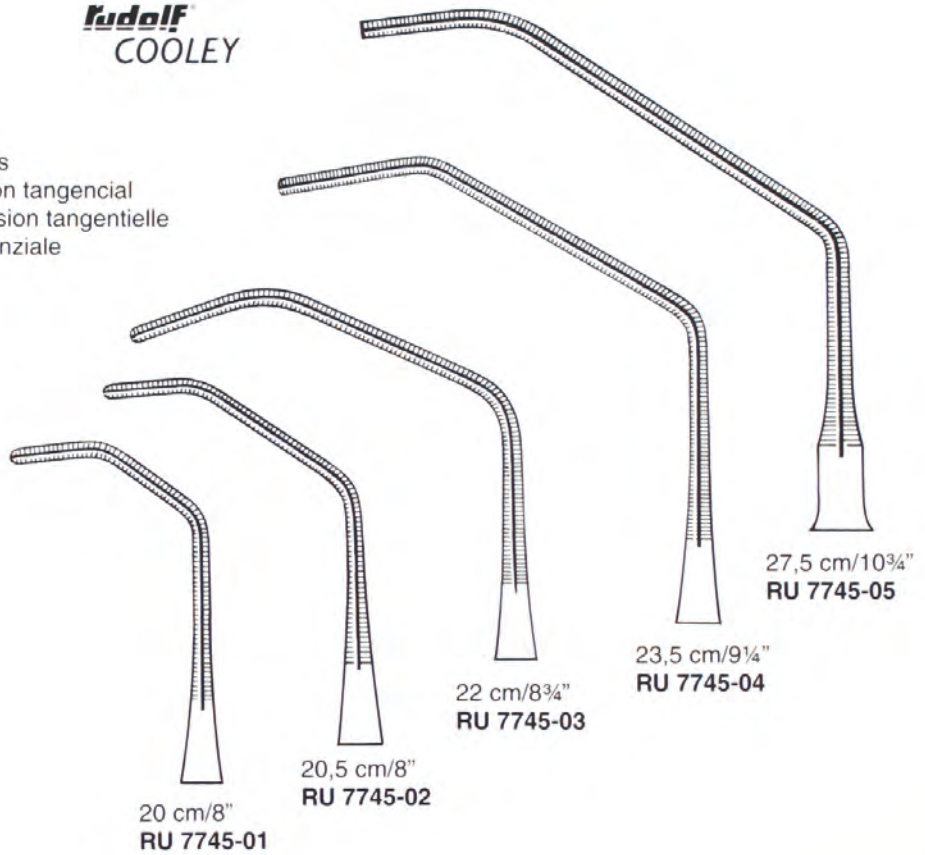

Cooley-Derra

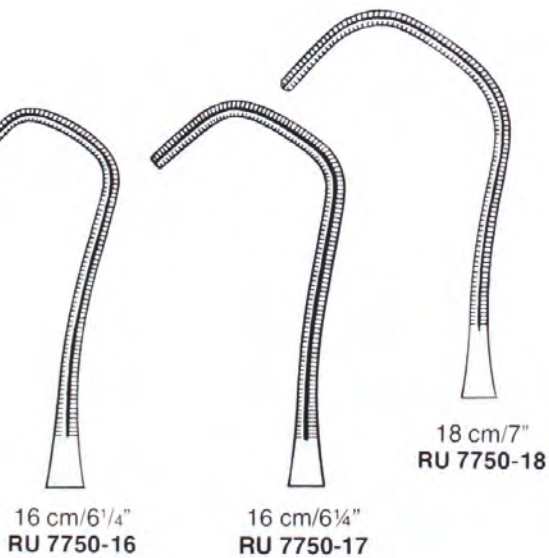

Ligaturklemmen  
 Ligature clamps  
 Pinzas-clamps para ligadura  
 Pinces-clamps pour la ligature  
 Pinze per legature



Cooley



Atrauma Kinderklemmen  
Atrauma Pediatric Clamps  
Atrauma Pinzas-clamps pediatricos  
Pincas-clamps atraumatiques pour la pédiatrie  
Pinze cardiovascolari atraumatiche per bambini



**Rudolf**  
COOLEY

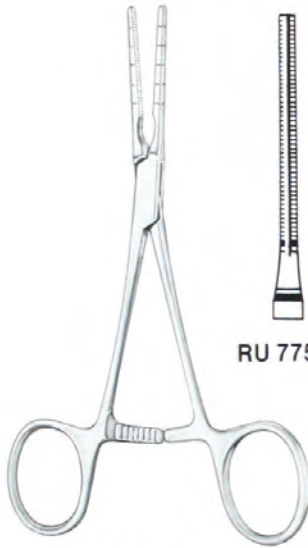

RU 7754-01

Cooley  
14 cm/5 1/2"



RU 7754-02



Cooley  
14 cm/5 1/2"  
RU 7754-03



Cooley  
14 cm/5 1/2"  
RU 7754-04



Cooley  
14 cm/5 1/2"  
RU 7754-05



**Rudolf**  
 COOLEY



**Cooley**  
 12,5 cm/5"  
 RU 7754-10



**Cooley**  
 12,5 cm/5"  
 RU 7754-11



**Cooley**  
 12,5 cm/5"  
 RU 7754-12



**Cooley**  
 12,5 cm/5"  
 RU 7754-14

graduirt  
 graduated  
 graduada  
 graduée  
 graduata

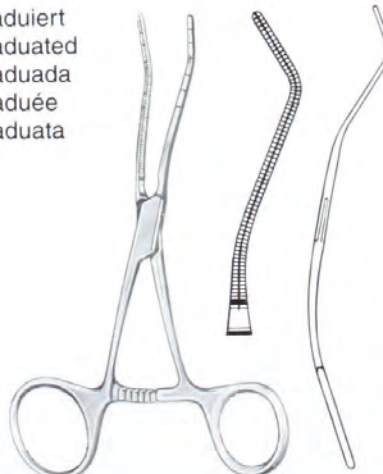

**Cooley**  
 12,5 cm/5"  
 RU 7754-15

graduirt  
 graduated  
 graduada  
 graduée  
 graduata

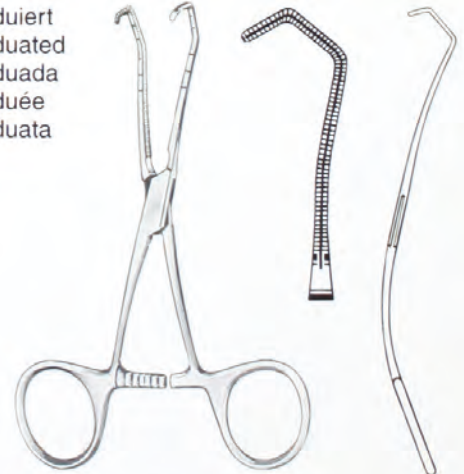

**Cooley**  
 12,5 cm/5"  
 RU 7754-18



Neonatal- und Kinderklemmen  
 Neonatal and Pediatric Clamps  
 Pinzas-clamps pediátricos y para recién nacidos  
 Pincas-clamps pour des enfants et nouveaux-nés  
 Pinze per neonati e bambini



**Rudolf**  
 COOLEY



ca. 15 cm



Fig.

1

2

3

4

5



Fig.

6

7

8

9

gerade  
 straight  
 rectas  
 droites  
 rette

Fig.

- 1 RU 7755-01
- 2 RU 7755-02
- 3 RU 7755-03
- 4 RU 7755-04
- 5 RU 7755-05
- 6 RU 7755-06
- 7 RU 7755-07
- 8 RU 7755-08
- 9 RU 7755-09



abgewinkelt  
 angled  
 acodadas  
 coudées  
 angolari

Fig.

- 1 RU 7756-01
- 2 RU 7756-02
- 3 RU 7756-03
- 4 RU 7756-04
- 5 RU 7756-05
- 6 RU 7756-06
- 7 RU 7756-07
- 8 RU 7756-08
- 9 RU 7756-09



gebogen  
 curved  
 curvas  
 courbes  
 curve

Fig.

- 1 RU 7757-01
- 2 RU 7757-02
- 3 RU 7757-03
- 4 RU 7757-04
- 5 RU 7757-05
- 6 RU 7757-06
- 7 RU 7757-07
- 8 RU 7757-08
- 9 RU 7757-09



**rudolf**  
 COOLEY



ca. 9 cm



Fig.



Fig.

gerade  
 straight  
 rectas  
 droites  
 rette

abgewinkelt  
 angled  
 acodadas  
 coudées  
 angolari

gebogen  
 curved  
 curvas  
 courbes  
 curve

Fig.

- 1 RU 7755-11
- 2 RU 7755-12
- 3 RU 7755-13
- 4 RU 7755-14
- 5 RU 7755-15
- 6 RU 7755-16
- 7 RU 7755-17
- 8 RU 7755-18
- 9 RU 7755-19



- 1 -
- 2 -
- 3 RU 7756-13
- 4 -
- 5 RU 7756-15
- 6 RU 7756-16
- 7 RU 7756-17
- 8 RU 7756-18
- 9 RU 7756-19



Fig.

- 1 RU 7757-11
- 2 RU 7757-12
- 3 RU 7757-13
- 4 RU 7757-14
- 5 RU 7757-15
- 6 RU 7757-16
- 7 RU 7757-17
- 8 RU 7757-18
- 9 RU 7757-19





**Cooley Neonatal Instrumenten-Set**  
**Cooley Neonatal Instrument Set**  
**Cooley, Juego de instrumental para recién nacidos**  
**Cooley, boîte à instruments pour des nouveaux-nés**  
**Cooley-Set di strumenti per neonati**



**Rudolf**  
**COOLEY**



komplett  
complete  
completo  
complet  
completo

**RU 7758-00**

**Inhalt**

- 1 x RU 6059-63 Micro-Ryder Nadelhalter
- 1 x RU 1316-14 Metzenbaum-Fino Schere
- 1 x RU 3328-14 Baby-Mixer Klemme
- 1 x **RU 7530-00 TI** Neonatal Titan Sternumsperrer
- 1 x RU 7754-18 Cooley Atrauma Klemme
- 1 x RU 7754-15 Cooley Atrauma Klemme
- 1 x RU 7754-14 Cooley Atrauma Klemme
- 1 x RU 7754-12 Cooley Atrauma Klemme
- 1 x RU 7754-11 Cooley Atrauma Klemme
- 1 x RU 7754-10 Cooley Atrauma Klemme
- 1 x **RU 7580-10/15 TI** Cooley Titan Pinzette
- 1 x RU 8904-07/01 Etui

**Content**

- 1 x RU 6059-63 needle holder Micro-Ryder
- 1 x RU 1316-14 scissors Metzenbaum-Fino
- 1 x RU 3328-14 forceps Baby-Mixer
- 1 x **RU 7530-00 TI** sternum spreader for newborns, titanium
- 1 x RU 7754-18 atraumatic clamps Cooley
- 1 x RU 7754-15 atraumatic clamps Cooley
- 1 x RU 7754-14 atraumatic clamps Cooley
- 1 x RU 7754-12 atraumatic clamps Cooley
- 1 x RU 7754-11 atraumatic clamps Cooley
- 1 x RU 7754-10 atraumatic clamps Cooley
- 1 x **RU 7580-10/15 TI** dissecting forceps De Bakey, titanium
- 1 x RU 8904-07/01 case

**Contenido**

- 1 x RU 6059-63 porta-aguja Micro-Ryder
- 1 x RU 1316-14 tijera Metzenbaum-Fino
- 1 x RU 3328-14 pinza Baby-Mixer
- 1 x **RU 7530-00 TI** separador de esternón para recién nacidos de titanio
- 1 x RU 7754-18 atrauma pinza-clamp Cooley
- 1 x RU 7754-15 atrauma pinza-clamp Cooley
- 1 x RU 7754-14 atrauma pinza-clamp Cooley
- 1 x RU 7754-12 atrauma pinza-clamp Cooley
- 1 x RU 7754-11 atrauma pinza-clamp Cooley
- 1 x RU 7754-10 atrauma pinza-clamp Cooley
- 1 x **RU 7580-10/15 TI** pinza de disección De Bakey, de titanio
- 1 x RU 8904-07/01 estuche

**Contenu**

- 1 x RU 6059-63 porte-aiguille Micro-Ryder
- 1 x RU 1316-14 ciseaux Metzenbaum-Fino
- 1 x RU 3328-14 pince Baby-Mixer
- 1 x **RU 7530-00 TI** écarteur à sternum néonatal, en titane
- 1 x RU 7754-18 pinces-clamps atraumatiques Cooley
- 1 x RU 7754-15 pinces-clamps atraumatiques Cooley
- 1 x RU 7754-14 pinces-clamps atraumatiques Cooley
- 1 x RU 7754-12 pinces-clamps atraumatiques Cooley
- 1 x RU 7754-11 pinces-clamps atraumatiques Cooley
- 1 x RU 7754-10 pinces-clamps atraumatiques Cooley
- 1 x **RU 7580-10/15 TI** pince à disséquer De Bakey, en titane
- 1 x RU 8904-07/01 boîte

**Contenuto**

- 1 x RU 6059-63 Portaghi Micro-Ryder
- 1 x RU 1316-14 Forbici Metzenbaum-fino
- 1 x RU 3328-14 Pinze Baby-Mixer
- 1 x **RU 7530-00 TI** Divaricatore per sterno per neonati, titanio
- 1 x RU 7754-18 Pinze cardiovascolari atraumatiche Cooley
- 1 x RU 7754-15 Pinze cardiovascolari atraumatiche Cooley
- 1 x RU 7754-14 Pinze cardiovascolari atraumatiche Cooley
- 1 x RU 7754-12 Pinze cardiovascolari atraumatiche Cooley
- 1 x RU 7754-11 Pinze cardiovascolari atraumatiche Cooley
- 1 x RU 7754-10 Pinze cardiovascolari atraumatiche Cooley
- 1 x **RU 7580-10/15 TI** Pinze cardiovascolare titanio De Bakey
- 1 x RU 8904-07/01 Scatole

**TI = TITAN**

Neonatal-Klemmen  
Neonatal Clamps  
Pinzas-clamps para recién nacidos  
Pincers-clamps pour des nouveaux-nés  
Pinze per neonati

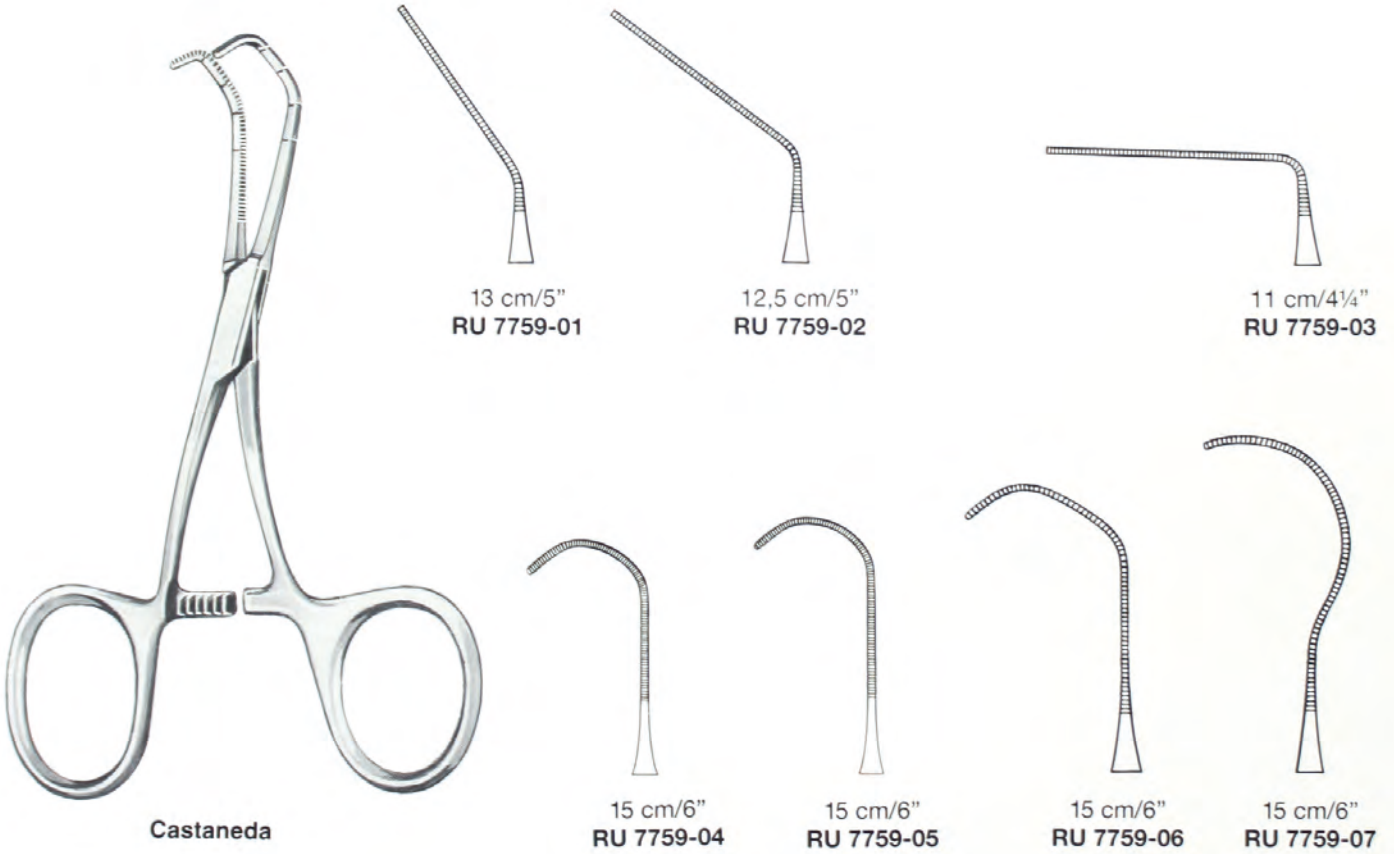
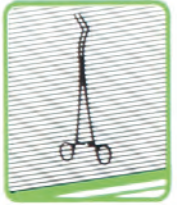



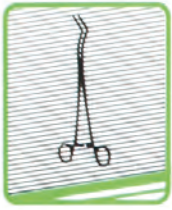

**Gefäßklemmen für auswechselbare Mauleinsätze**  
**Vessel Clamps for Interchangeable Jaw Inserts**  
**Pinzas vasculares para bocas intercambiables**  
**Pinces vasculaires pour des mors interchangeables**  
**Pinze vascolari atraumatiche con placche intercambiabili**



gerade  
straight  
rectas  
droites  
rette

für Einsätze  
for inserts  
para bocas  
pour mors  
per morso



abgewinkelt  
curved  
curvas  
courbes  
angolate

für Einsätze  
for inserts  
para bocas  
pour mors  
per morso



s-gebogen  
s-curved  
curva en s  
courbure en s  
s-curve

für Einsätze  
for inserts  
para bocas  
pour mors  
per morso

| cm/in  |                   |       |                   |       |                         |
|--------|-------------------|-------|-------------------|-------|-------------------------|
| 16/6¼  |                   |       | <b>RU 7760-25</b> | 33 mm |                         |
| 17/6¾  | <b>RU 7760-20</b> | 33 mm |                   |       |                         |
| 26/10¼ |                   |       | <b>RU 7760-40</b> | 61 mm | <b>RU 7760-45</b> 61 mm |
| 29/11½ | <b>RU 7760-30</b> | 61 mm | <b>RU 7760-50</b> | 86 mm |                         |

Einsätze für Gefäßklemmen (lieferbar in Box mit 10 Paar Einsätzen)  
 Inserts for vessel clamps (available in boxes with 10 pairs)  
 Bocas para pinzas vasculares (disponibles en cajas de 10 pares)  
 Mors pour pincers vasculaires (disponibles dans boîtes avec 10 paires)  
 Placche di ricambio per pinze vascolari atraumatiche (pacchetto di 10 paia)



33 mm  
**RU 7760-72**



61 mm  
**RU 7760-74**



86 mm  
**RU 7760-76**

**Etais für Bulldogklemmen**  
**Cases for Bulldog Clamps**  
**Estuches para clamps Bulldog**  
**Boîtes pour clamps bulldog**  
**Scatole per pinze Bulldog**





**Etuis für Bulldogklemmen  
Cases for Bulldog Clamps  
Estuches para clamps Bulldog  
Boîtes pour clamps bulldog  
Scatole per pinze Bulldog**



Ø 62 mm  
(ohne Bulldogklemmen)  
(without bulldog clamps)  
(sin clamps Bulldog)  
(sans clamps bulldog)  
(senza pinze Bulldog)

**RU 8916-11**



150 x 95 x 13 mm  
(ohne Bulldogklemmen, ohne Silikonband)  
(without bulldog clamps, without silicone tape)  
(sin clamps Bulldog, sin cinta de silicona)  
(sans clamps bulldog, sans ruban silicone)  
(senza pinze Bulldog, senza banco di silicone)

**RU 8917-01**

Inhaltsverzeichnis  
Index  
Indice  
Table des matières  
Indice



# Inhaltsverzeichnis



|  |                               |   |                         |  |                         |
|--|-------------------------------|---|-------------------------|--|-------------------------|
| <b>Acland Mod.</b> , Mikro-Gefäßklemmen.....     | 37                            | <b>Baby-Satinsky</b> , Gefäßklemmen .....         | 111                     | Atrauma Aorta-Aneurysma-                           |                         |
| <b>Adson</b> , Anatomische Pinzetten.....        | 43                            | <b>Bailey</b> , Rippenkontraktoren.....           | 108                     | klemmen, Titan .....                               | 122                     |
| Anatomische Pinzetten, Titan .....               | 43                            | <b>Bailey-Baby</b> , Rippenkontraktoren.....      | 108                     | Atrauma Aortaklemmen.....                          | 127                     |
| Arterienklemmen .....                            | 26                            | <b>Bailey-Gibbon</b> , Rippenkontraktoren.....    | 108                     | Atrauma Bulldogklemmen.....                        | 116, 117                |
| Atrauma-Pinzetten .....                          | 113                           | <b>Barraquer</b> , Nadelhalter .....              | 90                      | Atrauma Gefäß-                                     |                         |
| Chirurgische Pinzetten.....                      | 46                            | <b>Beck</b> , Atrauma Gefäßklemmen.....           | 130, 150                | klemmen .....                                      | 121, 130, 131, 138, 140 |
| Chirurgische Pinzetten, Titan.....               | 46                            | Atrauma Gefäßklemmen, Titan.....                  | 130                     | Atrauma Ligaturklemmen.....                        | 127                     |
| Mikro-Grip Pinzetten.....                        | 42                            | <b>Bengolea</b> , Arterienklemmen .....           | 27                      | Atrauma Mehrzweckklemmen .....                     | 133                     |
| Wundsperrerr .....                               | 55                            | <b>Bethune</b> , Rippenscheren .....              | 97                      | Atrauma Pinzetten .....                            | 113, 114                |
| <b>Adson-Brown</b> , Chirurgische Pinzetten..... | 46                            | <b>Biemer</b> , Mikro-Gefäßclips .....            | 39                      | Atrauma Pinzetten, Titan .....                     | 113, 114                |
| Chirurgische Pinzetten, Titan.....               | 46                            | <b>Biemer-Müller</b> , Mikro-Approximatoren ..... | 39                      | Atrauma Präparier- und                             |                         |
| <b>Alexander</b> , Raspatorien.....              | 68                            | <b>Blake</b> , Embolusfaßzangen .....             | 63                      | Ligaturklemmen .....                               | 120                     |
| <b>Allis-Atrauma</b> , Gewebe- und Organfaß-     |                               | <b>Borowski</b> , Aortenklappenhaken .....        | 54                      | Gefäß-Dilatatoren .....                            | 63                      |
| zangen.....                                      | 92                            | <b>Bozemann</b> , Nadelhalter .....               | 83                      | Gefäßscheren, TC .....                             | 10, 14                  |
| <b>Allison</b> , Lungenspatel.....               | 56                            | <b>Bridge</b> , Arterienklemmen.....              | 28                      | Gefäßscheren, TC .....                             | 14                      |
| <b>Alm</b> , Wundsperrerr .....                  | 55                            | Bronchusklemmen.....                              | 110, 126                | Mikro-Grip Nadelhalter .....                       | 81                      |
| Anastomosen-                                     |                               | <b>Brunner</b> , Sternumscheren .....             | 97                      | Nadelhalter .....                                  | 84, 85                  |
| klemmen .....                                    | 120, 129, 134, 139, 149       | <b>Bulldogklemmen</b> .....                       | 35, 115 – 118, 145, 153 | Nadelhalter, Titan.....                            | 84                      |
| Anatomische Pinzetten.....                       | 43 – 45                       | <b>Burford</b> , Rippensperrerr.....              | 107                     | Neonatal Instrumenten Set.....                     | 143                     |
| Anlegepinzetten.....                             | 37 – 39                       | <b>Böhler</b> , Knochensplitterzangen.....        | 73                      | Rippensperrerr .....                               | 103                     |
| Anlegezangen.....                                | 115                           | <b>Castaneda</b> , Neonatal-Klemmen.....          | 157                     | Saugkanülen.....                                   | 65                      |
| Aorta-Anastomosenklemmen .....                   | 130, 135                      | Rippensperrerr .....                              | 106                     | <b>De Bakey-Bahnsen</b> , Atrauma Aorta            |                         |
| Aorta-Aneurysmaklemmen.....                      | 122, 123, 136                 | <b>Castroviejo</b> , Mikro-Grip Nadelhalter.....  | 80                      | Aneurysmenklemmen.....                             | 136                     |
| Aorta-Dilatatoren .....                          | 62                            | Nadelhalter .....                                 | 89, 90                  | <b>De Bakey-Bainbridge</b> , Atrauma               |                         |
| Aortaklemmen .....                               | 28, 124, 127, 128, 139        | Nadelhalter, Titan .....                          | 89                      | Gefäßklemmen .....                                 | 121                     |
| Aortenklappenhaken .....                         | 54                            | Chirurgische Pinzetten .....                      | 46                      | <b>De Bakey-Beck</b> , Atrauma                     |                         |
| Aortenstanzen .....                              | 62                            | Chirurgische Scheren.....                         | 2, 3, 8                 | Gefäßklemmen .....                                 | 131                     |
| Approximatoren .....                             | 37, 39                        | Chirurgische Scheren, TC .....                    | 2, 3                    | <b>De Bakey-Castaneda</b> , Atrauma Herz-          |                         |
| Arterienklemmen .....                            | 24 – 28                       | <b>Cleveland</b> , Knochensplitterzangen .....    | 73                      | und Gefäßklemmen, Titan .....                      | 141                     |
| Atrauma Anastomosen-                             |                               | Clip-Anlegezangen .....                           | 35, 36                  | <b>De Bakey-Diethrich</b> , Atrauma-               |                         |
| klemmen .....                                    | 120, 129, 134, 135, 139, 149  | Coarctationsklemmen .....                         | 119, 136, 146           | Bulldogklemmen .....                               | 115                     |
| Aorta-Anastomosenklemmen .....                   | 130, 135                      | <b>Collin</b> , Rippenscheren .....               | 96                      | <b>De Bakey-Diethrich</b> , Atrauma-Pinzetten ..   | 113                     |
| Aorta-Anastomosenklemmen, Titan .....            | 130                           | <b>Cone</b> , Wundsperrerr .....                  | 55                      | <b>De Bakey-Gerald</b> , Atrauma-Pinzetten .....   | 113                     |
| Aorta-Aneurysmaklemmen .....                     | 122, 123, 136                 | <b>Converse</b> , Nadelhalter .....               | 85                      | <b>De Bakey-Pean</b> , Atrauma-                    |                         |
| Aortaklemmen .....                               | 124, 127, 128, 139            | <b>Cooley</b> , Aorta Dilatatoren .....           | 62                      | Arterienklemmen .....                              | 137                     |
| Arterienklemmen .....                            | 137                           | Atrauma Anastomosenklemmen.....                   | 149                     | <b>De Bakey-Rankin</b> , Atrauma-                  |                         |
| Aurikelklemmen .....                             | 125                           | Atrauma Bulldogklemmen .....                      | 145, 153                | Mehrzweckklemmen .....                             | 138                     |
| Bronchusklemmen .....                            | 126                           | Atrauma Coarctationsklemmen .....                 | 146                     | <b>De Bakey-Satinsky</b> , Atrauma-                |                         |
| Bronchusklemmen, Titan .....                     | 126                           | Atrauma Coarctationsklemmen, Titan.....           | 146                     | Bulldogklemmen .....                               | 116                     |
| Bulldogklemmen .....                             | 115 – 118, 145, 153           | Atrauma Gefäßklemmen.....                         | 138, 148 – 150          | <b>De Bakey-Semb</b> , Atrauma-                    |                         |
| Bulldogklemmen, Titan .....                      | 118                           | Atrauma Kinderklemmen .....                       | 152                     | Ligaturklemmen .....                               | 128                     |
| Coarctationsklemmen .....                        | 119, 136, 146                 | Atrauma Ligaturklemmen, Titan.....                | 151                     | <b>Deaver</b> , Lungenspatel.....                  | 52                      |
| Coarctationsklemmen, Titan .....                 | 146                           | Atrauma Mehrzweckklemmen .....                    | 147                     | <b>Deaver</b> , Wundhaken.....                     | 52, 53                  |
| Gefäß-   |                               | Atrauma Mehrzweckklemmen, Titan.....              | 147                     | <b>Derra De Bakey</b> , Atrauma Anastomosen-       |                         |
| klemmen .....                                    | 131, 132, 138, 140, 148 – 151 | Atrauma Pinzetten .....                           | 113                     | klemmen, Titan .....                               | 139                     |
| Gefäßklemmen, Titan .....                        | 130, 131                      | Atrauma Tangentialklemmen .....                   | 151                     | <b>Desmarres</b> , Gefäß- und Wundhäkchen.....     | 49                      |
| Herz- und Gefäßklemmen .....                     | 141                           | Atriumhaken.....                                  | 54                      | <b>Dick</b> , Atrauma Anastomosenklemmen .....     | 134                     |
| Herz- und Gefäßklemmen, Titan.....               | 141                           | Karotisklemmen .....                              | 144                     | <b>Diethrich</b> , Arterienklemmen.....            | 27                      |
| Kinderklemmen..                                  | 141 – 143, 152, 154 – 157     | Neonatal Instrumenten Set .....                   | 156                     | Atrauma Aortaklemmen.....                          | 124                     |
| Klemmen .....                                    | 119 – 157                     | Rippensperrerr .....                              | 102, 105                | Bulldogklemmen .....                               | 35                      |
| Ligaturklemmen .....                             | 127, 128, 138, 151            | Saugrohre.....                                    | 66                      | Nadelhalter .....                                  | 90                      |
| Ligaturklemmen, Titan .....                      | 128, 151                      | Wundhaken.....                                    | 54                      | <b>Doyen</b> , Raspatorien .....                   | 69                      |
| Mehrzweckklemmen .....                           | 133, 138, 147                 | <b>Cooley,-Derra</b> , Atrauma Gefäßklemmen ..    | 151                     | Drahtschere.....                                   | 76                      |
| Mehrzweckklemmen, Titan .....                    | 147                           | <b>Coryllos</b> , Wundhaken .....                 | 52                      | Drahtzangen .....                                  | 76 – 78                 |
| Mikro-Gefäßklemmen .....                         | 142                           | <b>Crafoord</b> , Arterienklemmen .....           | 28                      | <b>Duval</b> , Gewebe- und Organfaßzangen .....    | 93                      |
| Neonatal- und Kinderklemmen .....                | 154, 155                      | Arterienklemmen, Titan.....                       | 28                      | <b>Echlin</b> , Hohlmeißelzangen.....              | 72                      |
| Peripheral-Gefäßklemmen.....                     | 139                           | <b>Crafoord-Sellers</b> , Aortaklemmen .....      | 28                      | Einsätze für Gefäßklemmen .....                    | 158                     |
| Pinzetten.....                                   | 113, 114                      | <b>Crawford</b> , Wundhaken .....                 | 51                      | Embolusfaßzangen.....                              | 63                      |
| Pinzetten, Titan .....                           | 113                           | <b>Crile</b> , Gefäßhäkchen .....                 | 61                      | Endarterektomie-Scheren, Supercut .....            | 11                      |
| Profundaklemmen.....                             | 139                           | <b>Crile-Wood</b> , Nadelhalter .....             | 85                      | Endarterektomiestripper .....                      | 59                      |
| Profundaklemmen, Titan .....                     | 139                           | <b>Cushing</b> , Anatomische Pinzetten .....      | 45                      | Etus für Bulldogklemmen.....                       | 160                     |
| Präparier- und Ligaturklemmen .....              | 120                           | Gefäß- und Wundhäkchen .....                      | 48                      | <b>Eufrate-Pasque</b> , Nadelhalter.....           | 87                      |
| Subclavia Arterienklemmen .....                  | 131                           | Gefäßhäkchen .....                                | 61                      | <b>Favaloro</b> , Gefäßschere .....                | 10                      |
| Tangentialklemmen.....                           | 129, 151                      | <b>Cushing-Kocher</b> , Gefäß- und                |                         | Feine Scheren .....                                | 9                       |
| Tangentialklemmen, Titan.....                    | 129                           | Wundhäkchen.....                                  | 49                      | Feine Scheren, Supercut .....                      | 9                       |
| Atriumhaken .....                                | 54                            | <b>Dale</b> , Atrauma Peripheral-                 |                         | <b>Fergusson</b> , Knochenhalte zangen .....       | 70                      |
| Aurikelklemmen .....                             | 125                           | Gefäßklemmen .....                                | 139                     | Saugkanülen.....                                   | 65                      |
| <b>Babcock</b> , Gewebe- und Organfaßzangen ..   | 92                            | Hohlmeißelzangen.....                             | 72                      | <b>Finocchietto</b> , Nadelhalter.....             | 88                      |
| <b>Babcock-Atrauma</b> , Gewebe- und             |                               | <b>Dardik</b> , Atrauma Gefäßklemmen .....        | 132                     | Rippensperrerr .....                               | 101, 105, 107           |
| Organfaßzangen.....                              | 92                            | <b>Davidson</b> , Wundhaken.....                  | 54                      | <b>Finocchietto-Baby</b> , Rippensperrerr .....    | 100                     |
| <b>Baby-Adson</b> , Arterienklemmen .....        | 26                            | <b>Davidson-Alexander</b> , Raspatorien .....     | 68                      | <b>Finocchietto-Baby-Haight</b> ,                  |                         |
| <b>Baby-Crile-Wood</b> , Nadelhalter .....       | 85                            | <b>Davis</b> , Gefäßspatel .....                  | 60                      | Rippensperrerr .....                               | 107                     |
| <b>Baby-Hegemann</b> , Gefäßschere .....         | 14                            | <b>De Bakey</b> , Atrauma Aneurysmaklemmen ..     | 122                     | <b>Finocchietto-Burford</b> , Rippensperrerr ..... | 101                     |
| <b>Baby-Mixter</b> , Präparier- und              |                               | <b>De Bakey</b> ,                                 |                         | <b>Finocchietto-Mini</b> , Rippensperrerr .....    | 100                     |
| <b>Baby-Mixter</b> , Ligaturklemmen.....         | 32                            | Atrauma Aorta-Aneurysmaklemmen ..                 | 122, 123                | <b>Frazier</b> , Saugkanülen.....                  | 65                      |

|   |                 |  |  |  |               |
|---|-----------------|--|--|--|---------------|
| <b>Freer</b> , Gefäßspatel.....                           | 60              | Kinder- und Neugeborenen Herz- und Gefäßklemmen.....           | 141  | <b>Lees</b> , Atrauma Bronchusklemmen.....                         | 126           |
| <b>Frykholm</b> , Hohlmeißelzangen.....                   | 72              | Kinderklemmen.....   | 141 – 143, 152, 154 – 157                                  | Atrauma Bronchusklemmen, Titan.....                                | 126           |
| <b>Garrett</b> , Gefäß-Dilatatoren.....                   | 64              | Klemmen.....   | 24 – 39  | <b>Leksell</b> , Hohlmeißelzangen.....                             | 72            |
| Gefäßclips.....   | 36 – 39         | Aorta-.....  | 28   | <b>Leland-Jones</b> , Atrauma Klemmen.....                         | 121           |
| Gefäß-Dilatatoren.....                                    | 63, 64          | Arterien-.....   | 24 – 28  | <b>Leimon</b> , Nadelhalter.....                                   | 87            |
| Gefäßhäkchen.....   | 61              | Atrauma Anasto-<br>mosen-.....                                 | 120, 129, 134, 135, 139, 149                               | <b>Leriche</b> , Arterienklemmen.....                              | 25            |
| Gefäßinstrumente.....                                     | 58 – 66         | Atrauma Aorta-.....  | 124, 127, 128, 139   | Arterienklemmen, Titan.....  | 25            |
| Gefäßklemmen mit auswechselbaren<br>Mauleinsätzen.....    | 158             | Atrauma Aorta Anastomosen-.....                                | 130  | <b>Lexer</b> , Scheren, Supercut TC.....                           | 5             |
| Gefäßklemmen.....   | 110, 111        | Atrauma Aorta-Aneurysma-... ..                                 | 122, 123, 136  | Scheren, TC.....   | 5             |
| Gefäßscheren.....   | 10, 12 – 16, 21 | Atrauma Arterien-.....   | 137  | <b>Lichtenberg</b> , Nadelhalter.....                              | 88            |
| Gefäßscheren, TC.....                                     | 12 – 14         | Atrauma Aurikel-.....  | 125  | Ligaturscheren, TC.....  | 4             |
| Gefäßscheren, Titan.....                                  | 15, 16          | Atrauma Bronchus-.....   | 126  | <b>Liston</b> , Knochensplitterzangen.....                         | 73            |
| Gefäßspatel.....  | 60, 61          | Atrauma Bulldog-.....  | 115 – 118, 145, 153  | <b>Liston-Key</b> , Knochensplitterzangen.....                     | 74            |
| Gefäß-Spülkanülen.....                                    | 59              | Atrauma Coarctations-.....                                     | 119, 136, 146  | <b>Little</b> , Gefäß- und Wundhäkchen.....                        | 48            |
| Gefäß- und Wundhäkchen.....                               | 48, 49          | Atrauma<br>Gefäß-.....   | 130 – 132, 138, 140, 148 – 151                             | <b>Love (Morse)</b> , Gefäß- und Wundhäkchen... ..                 | 48            |
| <b>Gemini</b> , Präparier- und Ligaturklemmen.....        | 32              | Atrauma Herz- und Gefäß-.....                                  | 141  | <b>Lovelace</b> , Lungenfaßzangen.....                             | 110           |
| <b>Gerald</b> ,<br>Anatomische Pinzetten.....             | 43              | Atrauma Kinder-.....   | 152  | Lungenfaßzangen.....   | 110           |
| Anatomische Pinzetten, Titan.....                         | 43              | Atrauma Ligatur-.....  | 127, 128, 138, 151   | Lungenspatel.....  | 52 – 54, 56   |
| Chirurgische Pinzetten.....                               | 46              | Atrauma Mehrzweck-.....  | 133, 138, 147  | <b>Markwalder</b> , Knochensplitterzangen.....                     | 73            |
| Chirurgische Pinzetten, Titan.....                        | 46              | Atrauma Mikro-Gefäß-.....                                      | 142  | <b>Martin</b> , Wundhaken.....                                     | 51            |
| Gewebe- und Organfaßzangen.....                           | 92, 93          | Atrauma Neonatal- und Kinder-.....                             | 154, 155   | <b>Masson</b> , Nadelhalter.....                                   | 87            |
| <b>Giertz-Stille</b> , Rippenscheren.....                 | 96              | Atrauma Peripherale Gefäß-.....                                | 139  | <b>Mathieu-Kocher</b> , Nadelhalter.....                           | 88            |
| <b>Gil-Vernet</b> , Gefäß- und Wundhäkchen.....           | 48              | Atrauma Profunda-.....   | 139  | <b>Matson</b> , Raspatorien.....                                   | 68            |
| <b>Gillies</b> , Chirurgische Pinzetten.....              | 46              | Atrauma Präparier- und Ligatur-.....                           | 120  | <b>Mayo</b> , Ligaturscheren.....                                  | 4             |
| Chirurgische Pinzetten, Titan.....                        | 46              | Atrauma Subclavia Arterien-.....                               | 131  | Lungenfaßpinzetten.....  | 46            |
| <b>Glover</b> , Anastomosen-Klemmen.....                  | 120             | Atrauma Tangential-.....                                       | 129, 151   | Scheren.....   | 5             |
| Atrauma Anastomosenklemmen.....                           | 129, 135        | Atrauma Titan.....   | 119 – 122, 126, 128 – 131,<br>139, 141, 142, 146, 147, 151 | Scheren, TC.....   | 5             |
| <b>Glover</b> , Atrauma Bulldogklemmen.....               | 116, 145        | Atrauma Titan Anastomosen-.....                                | 139  | <b>Mayo-Hegar</b> , Nadelhalter.....                               | 83, 84        |
| <b>Gluck</b> , Rippenscheren.....                         | 96              | Atrauma Titan Aorta-.....                                      | 139  | Nadelhalter, Titan.....  | 83            |
| <b>Gregory</b> , Atrauma Profundaklemmen.....             | 139             | Atrauma Titan Bronchus-.....                                   | 126  | <b>McIndoe</b> , Anatomische Pinzetten.....                        | 43            |
| <b>Gregory-Soft</b> , Atrauma-Bulldogklemmen.....         | 117             | Atrauma Titan Coarctations-.....                               | 146  | Anatomische Pinzetten, Titan.....                                  | 43            |
| <b>Haight</b> , Rippensperrerr.....                       | 102             | Atrauma Titan Gefäß-.....                                      | 130, 131   | Knochensplitterzangen.....   | 73            |
| <b>Halle</b> , Gefäßspatel.....                           | 61              | Atrauma Titan Herz- und Gefäß-.....                            | 141  | Micro-Grip Pinzetten.....  | 42            |
| <b>Halsey</b> , Nadelhalter.....                          | 85              | Atrauma Titan Ligatur-.....                                    | 128, 151   | Mehrzweckklemmen.....  | 133, 138, 147 |
| Nadelhalter, Titan.....                                   | 85              | Atrauma Titan Mehrzweck-.....                                  | 147  | <b>Mercedes</b> , Thoraxsperrerr.....                              | 104           |
| <b>Halsted-Mosquito</b> , Arterienklemmen.....            | 25              | Atrauma Titan Tangential-.....                                 | 129  | <b>Metzenbaum</b> , Ligaturscheren.....                            | 4             |
| Arterienklemmen, Titan.....                               | 25              | Bulldog-.....  | 35, 115 – 118, 145, 153                                    | Präparierscheren.....  | 6 – 8         |
| <b>Harken</b> , Atrauma Aurikelklemmen.....               | 125             | Coarctations-.....   | 119  | Präparierscheren, TC.....  | 6 – 8         |
| Gefäßklemmen.....   | 111             | Karotis-.....  | 144  | Präparierscheren, TC, Supercut.....                                | 8             |
| <b>Harrington</b> , Präparier- und<br>Ligaturklemmen..... | 29              | Koronar-Arterien-Präparier-.....                               | 33   | <b>Metzenbaum-Fino</b> , Präparierscheren.....                     | 6, 7          |
| <b>Harrington</b> , Wundhaken.....                        | 53              | Mikro-Gefäß-.....  | 37   | Präparierscheren, TC.....  | 6, 7          |
| <b>Harrington-Baby</b> , Wundhaken.....                   | 53              | Titan.....   | 25, 26, 28   | <b>Micro-Mosquito</b> , Arterienklemmen.....                       | 26            |
| <b>Harrington-Pemberton</b> , Wundhaken.....              | 53              | <b>Klingenberg-Loth</b> , Gefäßscheren.....                    | 13   | Arterienklemmen, Titan.....  | 26            |
| <b>Hartmann</b> , Arterienklemmen.....                    | 26              | Gefäßscheren, TC.....  | 13   | <b>Micro-Ryder</b> , Nadelhalter.....                              | 86            |
| Arterienklemmen, Titan.....                               | 26              | Knochenraht.....   | 76   | Nadelhalter, Titan.....  | 86            |
| <b>Harvey</b> , Drahtscheren.....                         | 76              | Knochenhaken.....  | 50   | <b>Microvascular</b> , Mikro-Grip Nadelhalter.....                 | 81            |
| <b>Hegar-Vascular</b> , Nadelhalter.....                  | 86              | Knochenhalte­zangen.....                                       | 70   | Nadelhalter.....   | 86            |
| <b>Hegemann</b> , Gefäßscheren.....                       | 14              | Knocheninstrumente.....  | 68 – 78  | Mikro-Doppelspatel.....  | 59            |
| <b>Heiss</b> , Präparier- und Ligaturklemmen.....         | 31              | Knochensplitterzangen.....                                     | 73, 74   | Mikro-Gefäßclips.....  | 38, 39        |
| <b>Henly</b> , Atrauma Subclavia<br>Arterienklemmen.....  | 131             | <b>Kocher</b> , Arterienklemmen.....                           | 24   | Mikro-Gefäßklemmen.....  | 37            |
| Arterienklemmen.....                                      | 131             | Wundhaken.....   | 50   | Mikro-Gefäßklemmen für Frühgeborene... ..                          | 142           |
| <b>Hepp-Scheidel</b> , Nadelhalter.....                   | 90              | <b>Kocher-Langenbeck</b> , Wundhaken.....                      | 50   | Mikro-Grip Nadelhalter.....  | 80, 81        |
| Hohlmeißelzangen.....                                     | 71, 72          | Kopf- und Seitenschneider.....                                 | 78   | Mikro-Grip Pinzetten.....  | 42            |
| <b>Ima</b> , Mikro-Grip-Pinzette.....                     | 42              | Koronar-Arterien-Präparierklemmen.....                         | 33   | Mikro-Grip Ringpinzetten.....                                      | 42            |
| Mikro-Grip-Pinzette, Titan.....                           | 42              | Koronar-Scheren.....   | 10   | Mikro-Nadelhalter.....   | 82, 83        |
| <b>Jacobsen</b> , Gefäßscheren.....                       | 16              | <b>Krayenbühl</b> , Gefäßhäkchen.....                          | 61   | Mikro-Nadelhalter, Titan.....                                      | 83            |
| Gefäßscheren, Titan.....                                  | 16              | <b>König</b> , Gefäß- und Wundhäkchen.....                     | 49   | Mikro-Phlebextraktoren.....  | 59            |
| <b>Jacobson</b> , Mikro-Grip Nadelhalter.....             | 80              | <b>Lahey</b> (Sweet), Präparier- und Ligatur<br>klemmen.....   | 34   | Mikro-Pinzetten.....   | 43, 44        |
| Nadelhalter.....  | 90              | <b>Lambert-Kay</b> , Atrauma Aorta-<br>Anastomosenklemmen..... | 130  | Mikroscheren.....  | 17 – 20       |
| <b>Jacobson-Adson</b> , Arterienklemmen.....              | 27              | Atrauma Aorta-Anastomosenklemmen,<br>Titan.....                | 130  | Mikroscheren, Titan.....   | 19, 20        |
| <b>Jacobson-Halsted</b> , Arterienklemmen.....            | 25              | <b>Lambotte</b> , Raspatorien.....                             | 68   | <b>Mikulicz</b> , Wundhaken.....                                   | 51            |
| <b>Jameson-Werber</b> , Scheren.....                      | 9               | <b>Langenbeck</b> , Knochenhalte­zangen.....                   | 70   | <b>Millesi</b> , Mikroscheren.....                                 | 18            |
| <b>Javid</b> , Karotisklemmen.....                        | 144             | Raspatorien.....   | 68   | <b>Mills</b> , Gefäßscheren.....                                   | 21            |
| <b>Jorgensen</b> , Gefäßscheren.....                      | 13              | <b>Langenbeck</b> , Wundhaken.....                             | 50   | <b>Mini-Gemini</b> , Präparier- und<br>Ligaturklemmen.....         | 32            |
| <b>Joseph</b> , Scheren.....                              | 9               | <b>Langenbeck-Ryder</b> , Nadelhalter.....                     | 88   | Ligaturklemmen.....  | 32            |
| <b>Kader</b> , Wundhaken.....                             | 53              | <b>Lawrence</b> , Präparier- und Ligaturklemmen.....           | 34   | Mini-Phlebextraktoren.....   | 59            |
| <b>Kalt</b> , Nadelhalter.....                            | 89              | <b>Lazar</b> , Mikro-Pinzetten.....                            | 45   | <b>Mixer</b> , Präparier- und Ligaturklemmen.....                  | 33            |
| <b>Kantrowitz</b> , Präparier- und<br>Ligaturklemmen..... | 29              | <b>Lebsche</b> , Sternummeißel.....                            | 97   | <b>Mixer O'Shaughnessy</b> , Präparier- und<br>Ligaturklemmen..... | 33            |
| Karotisklemmen.....                                       | 144             |  |  | <b>Morris-De Bakey</b> , Atrauma Aorta-<br>Anastomosenklemmen..... | 135           |
| <b>Kelly</b> , Scheren.....                               | 8               |  |  | <b>Morse</b> , Rippensperrerr.....                                 | 106           |
| Wundhaken.....  | 51              |  |  | <b>Morse-Favaloro</b> , Rippensperrerr.....                        | 104, 106      |
|   |                 |  |  | <b>Mosquito</b> , Atrauma Arterienklemmen.....                     | 137           |
|   |                 |  |  | <b>Myers</b> , Venenstripper.....                                  | 58            |

# Inhaltsverzeichnis



|   |                           |   |                              |  |         |
|---|---------------------------|---|------------------------------|--|---------|
| <b>Müller</b> , Approximatoren.....                 | 39                        | Saugkanülen.....                                    | 65                           | Venenstripper-Besteck .....                        | 58      |
| Gefäßclips.....                                     | 38                        | Saugrohre.....                                      | 66                           | Venenstripper .....                                | 58      |
| <b>Nabattoff</b> , Venenstripper-Besteck .....      | 58                        | <b>Sawtell</b> , Präparier- und Ligaturklemmen..... | 33                           | <b>Volkmann</b> , Wundhaken.....                   | 50      |
| Nadelhalter .....                                   | 80 – 90                   | Scheren .....                                       | 2 – 21                       | <b>Wangenstein</b> , Anatomische Pinzetten.....    | 45      |
| <b>Nelson</b> , Faßpinzetten.....                   | 46                        | Chirurgische-.....                                  | 2, 3, 8                      | <b>Weber</b> , Atrauma Aortaklemmen.....           | 128     |
| Neonatal Instrumenten Set .....                     | 143, 156                  | Chirurgische-, TC.....                              | 2, 3                         | <b>Weitlaner</b> , Wundsperrer.....                | 55, 56  |
| Neonatal-Klemmen.....                               | 157                       | Endarterektomie-, Supercut.....                     | 11                           | <b>Wertheim</b> , Atrauma Anastomosen-             |         |
| Neonatal Sternumsperrer, Titan .....                | 108                       | Feine-.....   | 9                            | klemmen .....                                      | 134     |
| <b>Ochsner</b> , Atrauma Aortaklemmen .....         | 124                       | Feine-, Supercut .....                              | 9                            | <b>Wickstroem</b> , Präparier- und                 |         |
| <b>Ochsner-Kocher</b> , Arterienklemmen .....       | 24                        | Gefäß-.....   | 10, 12– 16, 21               | Ligaturklemmen .....                               | 34      |
| <b>Overholt</b> , Präparier- und Ligaturklemmen ..  | 30                        | Gefäß-, Titan.....                                  | 15, 16                       | <b>Williams</b> , Gewebe- und Organfaßzangen... 92 |         |
| <b>Overholt-Geissendörfer</b> , Präparier- und      |                           | Koronar-.....                                       | 10                           | Wundhaken.....                                     | 48 – 54 |
| Ligaturklemmen .....                                | 31                        | Ligatur-, TC.....                                   | 4                            | Wundsperrer.....                                   | 55, 56  |
| <b>Overholt-Mixer</b> , Präparier- und Ligatur..... |                           | Mikro-.....   | 17 – 20                      | <b>Wylie</b> , Atrauma Gefäßklemmen .....          | 123     |
| klemmen.....  | 31                        | Mikro-, Titan .....                                 | 19, 20                       | <b>Yankauer</b> , Saugkanülen.....                 | 65      |
| <b>Overholt-Slim</b> , Präparier- und Ligatur       |                           | Präparier-.....                                     | 5 – 8                        | <b>Zenker</b> , Wundhaken .....                    | 53      |
| klemmen .....                                       | 30                        | Präparier-, Supercut TC.....                        | 5, 8                         | <b>Zweifel</b> , Nadelhalter .....                 | 88      |
| <b>Pean</b> , Arterienklemmen.....                  | 24                        | Präparier-, TC .....                                | 5                            |  |         |
| Peripheral-Gefäßklemmen.....                        | 139                       | Supercut.....                                       | 11                           |  |         |
| Phlebodissektoren .....                             | 59                        | Titan.....  | 15, 16, 19, 20               |  |         |
| Phleboextraktoren .....                             | 59                        | Venen- .....  | 18                           |  |         |
| Phlebektomie-Haken .....                            | 60                        | <b>Schmid</b> , Gefäß-Spülkanülen.....              | 59                           |  |         |
| Pinzetten.....                                      | 42 – 46                   | Gefäßspatel .....                                   | 60                           |  |         |
| Anatomische.....                                    | 43, 45                    | <b>Schwartz</b> , Clip-Anlegezangen .....           | 35                           |  |         |
| Anlege- .....                                       | 37 – 39                   | Seitenschneider.....                                | 78                           |  |         |
| Atrauma-.....                                       | 113, 114                  | <b>Sellors</b> , Rippenkontraktoren .....           | 108                          |  |         |
| Chirurgische-.....                                  | 46                        | <b>Semb</b> , Hohlmeißelzangen.....                 | 71                           |  |         |
| Faß-.....   | 45                        | Knochenhaltezangen .....                            | 70                           |  |         |
| Lungenfaß-.....                                     | 46                        | Knochensplitterzangen .....                         | 74                           |  |         |
| Mikro-.....   | 43, 44                    | Präparier- und Ligaturklemmen .....                 | 110                          |  |         |
| Mikro-Grip.....                                     | 42                        | Raspatorien .....                                   | 69                           |  |         |
| Mikro-Knüpfp-.....                                  | 45                        | Sicherungsschloß.....                               | 119                          |  |         |
| Ring-.....  | 42                        | Silikonband .....                                   | 160                          |  |         |
| Titan.....  | 43, 44, 46                | <b>Simon</b> , Wundhaken.....                       | 51                           |  |         |
| Tumorfäß-.....                                      | 44                        | <b>Singley-Tuttle</b> , Faßpinzetten .....          | 46                           |  |         |
| <b>Potts</b> , Atrauma Coarctations-Klemmen.....    | 119                       | Spülkanülen.....                                    | 59                           |  |         |
| Atrauma-Klemmen.....                                | 119                       | <b>Standard</b> , Scheren.....                      | 2, 3                         |  |         |
| Coarctations-Klemmen .....                          | 119                       | Sterilisierbehälter.....                            | 64                           |  |         |
| <b>Potts-De Martel</b> , Gefäßscheren .....         | 21                        | Sternumscheren .....                                | 96                           |  |         |
| <b>Potts-Smith</b> , Anatomische Pinzetten.....     | 45                        | <b>Stille</b> , Hohlmeißelzangen .....              | 72                           |  |         |
| Gefäßscheren .....                                  | 10, 12, 13                | Rippenscheren.....                                  | 96                           |  |         |
| Gefäßscheren, Supercut.....                         | 11                        | <b>Stille-Liston</b> , Knochensplitterzangen .....  | 74                           |  |         |
| Gefäßscheren, TC .....                              | 12                        | <b>Stille-Luer</b> , Hohlmeißelzangen .....         | 71                           |  |         |
| <b>Price-Thomas</b> , Bronchusklemmen .....         | 110                       | <b>Stille-Ruskin</b> , Hohlmeißelzangen.....        | 71                           |  |         |
| Profundaklemmen .....                               | 139                       | <b>Struck</b> , Rippensperrer.....                  | 100                          |  |         |
| Präparier- und Ligatur-                             |                           | <b>Strully</b> , Gefäßscheren.....                  | 21                           |  |         |
| klemmen .....                                       | 26, 27, 29 – 34, 110, 120 | Subclavia Arterienklemmen.....                      | 131                          |  |         |
| Präparierscheren .....                              | 5 – 8                     | <b>Subramanian-Miniature</b> , Atrauma              |                              |  |         |
| Raspatorien .....                                   | 68, 69                    | Aortaklemmen .....                                  | 139                          |  |         |
| <b>Reynolds</b> , Scheren .....                     | 9                         | Atrauma Aortaklemmen, Titan .....                   | 139                          |  |         |
| Scheren, Supercut.....                              | 9                         | Tangentialklemmen.....                              | 129, 151                     |  |         |
| <b>Rienhoff-Finocchietto</b> , Rippensperrer.....   | 102                       | Thoraxsperrer .....                                 | 104                          |  |         |
| Ringpinzetten.....                                  | 42                        | Titan Atrauma-Bulldogklemmen .....                  | 118                          |  |         |
| Rippenkontraktoren .....                            | 108                       | Titan Atrauma-.....                                 | 119 – 122, 126, 128 – 131,   |  |         |
| Rippenscheren .....                                 | 96, 97                    | Klemmen.....  | 139, 141, 142, 146, 147, 151 |  |         |
| Rippensperrer .....                                 | 100 – 108                 | Titan Klemmen .....                                 | 25, 26, 28                   |  |         |
| <b>Rochester-Pean</b> , Arterienklemmen .....       | 24                        | Titan Nadelhalter .....                             | 83 – 86, 89                  |  |         |
| <b>Ross</b> , Wundhaken.....                        | 54                        | Titan Neonatal Sternumsperrer .....                 | 108                          |  |         |
| <b>Rudolf</b> , Nadelhalter.....                    | 86                        | Titan Pinzetten.....                                | 43, 44, 46                   |  |         |
| <b>Rumel</b> , Präparier- und Ligaturklemmen .....  | 29                        | Titan Scheren .....                                 | 15, 16, 19, 20               |  |         |
| <b>Rumel-Belmont</b> , Tourniquets .....            | 66                        | <b>Toennis</b> , Gefäßspatel .....                  | 60                           |  |         |
| <b>Ruskin-Liston</b> , Knochensplitterzangen.....   | 74                        | <b>Tönnis</b> , Nadelhalter .....                   | 88                           |  |         |
| <b>Ryder</b> , Mikro-Grip Nadelhalter .....         | 81                        | <b>Tönnis-Adson</b> , Gefäßscheren, TC .....        | 13                           |  |         |
| Nadelhalter .....                                   | 86                        | Tourniquets .....                                   | 66                           |  |         |
| <b>Santulli</b> , Atrauma-Bulldogklemmen .....      | 117                       | <b>Tubbs</b> , Aorta Dilatatoren.....               | 62                           |  |         |
| Atrauma-Bulldogklemmen, Titan.....                  | 117                       | Tumorfäßpinzetten .....                             | 44                           |  |         |
| <b>Sarot</b> , Arterienklemmen .....                | 28                        | <b>Universal</b> , Drahtscheren.....                | 76                           |  |         |
| Nadelhalter .....                                   | 87                        | <b>Varady</b> , Mikro-Doppelspatel.....             | 59                           |  |         |
| <b>Satinsky</b> , Gefäßklemmen .....                | 111                       | <b>Varady</b> , Mikro-Phlebextraktoren.....         | 59                           |  |         |
| Gefäßscheren .....                                  | 13                        | Mini-Phlebextraktoren .....                         | 59                           |  |         |
| <b>Satinsky/DeBakey</b> , Atrauma                   |                           | Phlebodissektoren .....                             | 59                           |  |         |
| Tangentialklemmen.....                              | 129                       | <b>Varady</b> , Phleboextraktoren.....              | 59                           |  |         |
| <b>Sauerbruch</b> , Hohlmeißelzangen.....           | 72                        | Varizeninstrumente .....                            | 59                           |  |         |
| <b>Sauerbruch</b> , Rippenscheren.....              | 96                        | Varizeninstrumente.....                             | 59                           |  |         |
| Wundhaken.....                                      | 52                        | Venenscheren.....                                   | 18                           |  |         |

# Index



|  |                              |  |                         |  |                         |
|--|------------------------------|--|-------------------------|--|-------------------------|
| <b>Acland Mod.</b> , micro vascular forceps .....    | 37                           | <b>Baby-Satinsky</b> , cardiovascular clamps ....    | 111                     | coronary artery dissecting .....                       | 33                      |
| <b>Adson</b> , atraumatic dressing forceps .....     | 113                          | <b>Bailey</b> , rib contractors .....                | 108                     | micro vascular .....                                   | 37                      |
| dressing forceps, titanium .....                     | 43                           | <b>Bailey-Baby</b> , rib contractors .....           | 108                     | <b>Cleveland</b> , bone cutting forceps .....          | 73                      |
| dressing forceps .....                               | 43                           | <b>Bailey-Gibbon</b> , rib contractors .....         | 108                     | Clip applying forceps .....                            | 35 – 36                 |
| hemostatic forceps .....                             | 26                           | <b>Barraquer</b> , needle holders .....              | 90                      | Coarctation clamps .....                               | 119, 136, 146           |
| micro-grip forceps .....                             | 42                           | <b>Beck</b> , atraumatic cardiovascular clamps,      |                         | <b>Colling</b> , rib shears .....                      | 96                      |
| retractors .....                                     | 55                           | titanium .....                                       | 130                     | <b>Cone</b> , retractors .....                         | 55                      |
| tissue forceps, titanium .....                       | 46                           | <b>Beck</b> , atraumatic cardiovascular              |                         | <b>Converse</b> , needle holders .....                 | 85                      |
| tissue forceps .....                                 | 46                           | clamps .....   | 130, 150                | <b>Cooley</b> , aortic dilators .....                  | 62                      |
| <b>Adson-Brown</b> , tissue forceps, titanium .....  | 46                           | <b>Bengolea</b> , hemostatic forceps .....           | 27                      | aspiration tubes .....                                 | 66                      |
| tissue forceps .....                                 | 46                           | <b>Bethune</b> , rib shears .....                    | 97                      | atraumatic anastomosis clamps .....                    | 149                     |
| <b>Alexander</b> , periosteal raspatories .....      | 68                           | <b>Biemer</b> , micro vessel clips .....             | 39                      | atraumatic bulldog clamps .....                        | 145, 153                |
| <b>Allis-Atrauma</b> , tissue and organ grasping     |                              | <b>Bierner-Müller</b> , micro approximators .....    | 39                      | atraumatic cardiovascular                              |                         |
| forceps .....  | 92                           | <b>Blake</b> , embolus grasping forceps .....        | 63                      | clamps .....   | 138, 148– 150           |
| <b>Allison</b> , lung spatulas .....                 | 56                           | Bone cutting forceps .....                           | 73, 74                  | atraumatic coarctation clamps .....                    | 146                     |
| <b>Alm</b> , retractors .....                        | 55                           | holding forceps .....                                | 70                      | atraumatic coarctation clamps,                         |                         |
| Anastomosis clamps .....                             | 120, 129, 134, 139, 149      | hooks .....  | 50                      | titanium .....   | 146                     |
| Aorta valve retractors .....                         | 54                           | instruments .....                                    | 68 – 78                 | atraumatic dressing forceps .....                      | 113                     |
| Aortic anastomosis clamps .....                      | 130, 135                     | rongeurs .....                                       | 71, 72                  | atraumatic ligature clamps, titanium .....             | 151                     |
| aneurysm clamps .....                                | 122, 123, 136                | wire .....   | 76                      | atraumatic multi purpose clamps .....                  | 147                     |
| clamps .....   | 28, 124, 127, 128, 139       | <b>Borowski</b> , aorta valve retractors .....       | 54                      | atraumatic multi purpose clamps,                       |                         |
| dilators .....                                       | 62                           | <b>Bozemann</b> , needle holders .....               | 83                      | titanium .....   | 147                     |
| punches .....  | 62                           | <b>Bridge</b> , hemostatic forceps .....             | 28                      | atraumatic pediatric clamps .....                      | 152                     |
| Applying forceps .....                               | 37 – 39                      | Bronchus clamps .....                                | 110, 126                | atraumatic tangential occlusion clamps .....           | 151                     |
| Approximators .....                                  | 37, 39                       | <b>Brunner</b> , sternum scissors .....              | 97                      | atrium retractor .....                                 | 54                      |
| Atraumatic anastomosis                               |                              | Bulldog clamps .....                                 | 35, 115 – 118, 145, 153 | carotid clamps .....                                   | 144                     |
| clamps .....   | 120, 129, 134, 135, 139, 149 | <b>Burford</b> , rib spreaders .....                 | 107                     | neonatal instrument set .....                          | 156                     |
| aortic anastomosis clamps .....                      | 130, 135                     | <b>Böhler</b> , bone cutting forceps .....           | 73                      | retractors .....                                       | 54                      |
| aortic anastomosis clamps,                           |                              | Cardiovascular clamps for children                   |                         | rib spreader .....                                     | 102, 105                |
| titanium .....                                       | 130                          | and newborn .....                                    | 141                     | <b>Cooley-Derra</b> , atraumatic cardiovascular        |                         |
| aortic aneurysm clamps .....                         | 122, 123, 136                | Carotid clamps .....                                 | 144                     | clamps .....   | 151                     |
| aortic clamps .....                                  | 124, 127, 128, 139           | Cases for bulldog clamps .....                       | 160                     | Coronary artery dissecting clamps .....                | 33                      |
| auricle clamps .....                                 | 125                          | <b>Castaneda</b> , neonatal clamps .....             | 157                     | scissors .....   | 10                      |
| bronchus clamps, titanium .....                      | 126                          | rib spreader .....                                   | 106                     | <b>Coryllos</b> , retractors .....                     | 52                      |
| bronchus clamps .....                                | 126                          | <b>Castroviejo</b> , micro-grip needle holders ..... | 80                      | <b>Crafoord</b> , hemostatic forceps, titanium .....   | 28                      |
| bulldog clamps, titanium .....                       | 118                          | needle holders, titanium .....                       | 89                      | hemostatic forceps .....                               | 28                      |
| bulldog clamps .....                                 | 115 – 118, 145, 153          | needle holders .....                                 | 89, 90                  | <b>Crafoord-Sellors</b> , aortic clamps .....          | 28                      |
| cardiovascular clamps .....                          | 141                          | Clamps,  |                         | <b>Crawford</b> , retractors .....                     | 51                      |
| cardiovascular clamps, titanium .....                | 141                          | aorta .....  | 28                      | <b>Crile</b> , vessel hooks .....                      | 61                      |
| cardiovascular forceps .....                         | 130 – 132,                   | atraumatic anastomosis, titanium .....               | 139                     | <b>Crile-Wood</b> , needle holders .....               | 85                      |
| 138, 140, 148 – 151                                  |                              | atraumatic aorta anastomosis .....                   | 130                     | <b>Cushing</b> , dressing forceps .....                | 45                      |
| clamps for children .....                            | 141 – 143, 152,              | atraumatic aorta anastomosis, titanium .....         | 130                     | vessel and wound retractors .....                      | 48                      |
| 154 – 157  |                              | atraumatic aorta aneurysm .....                      | 122, 123, 136           | vessel hooks .....                                     | 61                      |
| clamps .....   | 119 – 157                    | atraumatic aorta,                                    |                         | <b>Cushing-Kocher</b> , vessel and wound               |                         |
| coarctation clamps, titanium .....                   | 146                          | titanium .....                                       | 124, 127, 128, 139      | retractors .....                                       | 49                      |
| coarctation clamps .....                             | 119, 136, 146                | atraumatic aorta, titanium .....                     | 139                     | <b>Dale</b> , atraumatic peripheral vascular           |                         |
| dissecting and ligature clamps .....                 | 120                          | atraumatic auricle .....                             | 125                     | clamps .....   | 139                     |
| dressing forceps, titanium .....                     | 113                          | atraumatic bronchus, titanium .....                  | 126                     | bone rongeur forceps .....                             | 72                      |
| dressing forceps .....                               | 113, 114                     | atraumatic bronchus .....                            | 126                     | <b>Dardik</b> , atraumatic cardiovascular clamps ..... | 132                     |
| hemostatic forceps .....                             | 137                          | atraumatic bulldog .....                             | 115 – 118, 145, 153     | <b>Davidson</b> , retractors .....                     | 54                      |
| ligature clamps, titanium .....                      | 151                          | atraumatic cardiovascular .....                      | 141                     | <b>Davidson-Alexander</b> , raspatories .....          | 68                      |
| ligature clamps .....                                | 127, 128, 138, 151           | atraumatic cardiovascular, titanium .....            | 141                     | <b>Davis</b> , vessel spatulas .....                   | 60                      |
| micro vascular clamps .....                          | 142                          | atraumatic coarctation, titanium .....               | 146                     | <b>De Bakey</b> , atraumatic aneurysm clamps .....     | 122                     |
| multi purpose clamps, titanium .....                 | 147                          | atraumatic coarctation and ligature .....            | 120                     | atraumatic aortic aneurysm                             |                         |
| multi purpose clamps .....                           | 133, 138, 147                | atraumatic ligature, titanium .....                  | 128, 151                | clamps .....   | 122, 123                |
| pediatric clamps .....                               | 154, 155                     | atraumatic ligature .....                            | 127, 128, 138, 151      | atraumatic aortic aneurysm clamps,                     |                         |
| peripheral clamps .....                              | 139                          | atraumatic micro-vascular .....                      | 142                     | titanium .....   | 122                     |
| profunda clamps, titanium .....                      | 139                          | atraumatic multi purpose .....                       | 133, 138, 147           | atraumatic aortic clamps .....                         | 127                     |
| profunda clamps .....                                | 139                          | atraumatic multi purpose, titanium .....             | 147                     | atraumatic bulldog clamps .....                        | 116, 117                |
| subclavian artery clamps .....                       | 131                          | atraumatic neonatal and children                     |                         | atraumatic cardiovascular                              |                         |
| tangential occlusion clamps .....                    | 129, 151                     | clamps .....   | 154, 155                | clamps .....   | 121, 130, 131, 138, 140 |
| titanium cardiovascular forceps .....                | 131                          | atraumatic pediatric .....                           | 152                     | atraumatic dissecting and ligature                     |                         |
| titanium ligature clamps .....                       | 128                          | atraumatic peripheral .....                          | 139                     | clamps .....   | 120                     |
| titanium tangential occlusion clamps .....           | 129                          | atraumatic profunda .....                            | 139                     | atraumatic dressing forceps,                           |                         |
| Atrium retractors .....                              | 54                           | atraumatic subclavia artery .....                    | 131                     | titanium .....   | 113, 114                |
| Auricle clamps .....                                 | 125                          | atraumatic tangential occlusion,                     |                         | atraumatic dressing forceps .....                      | 113, 114                |
| <b>Babcock</b> , tissue and organ grasping           |                              | titanium .....                                       | 129                     | atraumatic ligature clamps .....                       | 127                     |
| forceps .....  | 92                           | atraumatic, titanium .....                           | 119 – 122, 126,         | atraumatic multi purpose clamps .....                  | 133                     |
| <b>Babcock-Atrauma</b> , tissue and organ            |                              | 128 – 131, 139, 141, 142, 146, 147, 151              |                         | micro-grip needle holders .....                        | 81                      |
| grasping forceps .....                               | 92                           | atraumatic vascular, titanium .....                  | 130, 131                | needle holders, titanium .....                         | 84                      |
| <b>Baby-Adson</b> , hemostatic forceps .....         | 26                           | atraumatic vascular .....                            | 130 – 132, 138,         | needle holders .....                                   | 84, 85                  |
| <b>Baby-Crile-Wood</b> , needle holders .....        | 85                           | 140, 148 – 151                                       |                         | neonatal instrument set .....                          | 143                     |
| <b>Baby-Hegemann</b> , cardiovascular scissors ..... | 14                           | bulldog .....  | 35, 115 – 118, 145, 153 | rib spreaders .....                                    | 103                     |
| <b>Baby-Mixter</b> , dissecting and ligature         |                              | carotid .....  | 144                     | <b>De Bakey</b> , suction tubes .....                  | 65                      |
| <b>Baby-Mixer</b> , clamps .....                     | 32                           | Clamps, coarctation .....                            | 119                     | vascular scissors, TC .....                            | 14                      |



# Index



|   |                   |   |          |   |             |
|---|-------------------|---|----------|---|-------------|
| vascular scissors .....                               | 10, 14            | <b>Freer</b> , vessel spatulas .....                      | 60       | periosteal raspatories .....                            | 68          |
| vessel dilators .....                                 | 63                | <b>Frykholm</b> , bone rongeur forceps .....              | 72       | retractors .....  | 50          |
| <b>De Bakey-Bahnson</b> , atraumatic aortic           |                   | <b>Garrett</b> , vessel dilators .....                    | 64       | <b>Langenbeck-Ryder</b> , needle holders .....          | 88          |
| aneurysm clamps .....                                 | 136               | <b>Gemini</b> , dissecting and ligature clamps .....      | 32       | Lateral and frontal cutting pliers .....                | 78          |
| <b>De Bakey-Bainbridge</b> , atraumatic cardio-       |                   | <b>Gerald</b> , dressing forceps .....                    | 43       | <b>Lawrence</b> , dissecting and ligature forceps ..... | 34          |
| vascular clamps .....                                 | 121               | dressing scissors, titanium .....                         | 43       | <b>Lazar</b> , micro dressing forceps .....             | 45          |
| <b>De Bakey-Beck</b> , atraumatic cardio-             |                   | tissue forceps, titanium .....                            | 46       | <b>Lebsche</b> , sternum chisels .....                  | 97          |
| vascular clamps .....                                 | 131               | tissue forceps .....                                      | 46       | <b>Lees</b> , atraumatic bronchus forceps .....         | 126         |
| <b>De Bakey-Castaneda</b> , atraumatic cardio-        |                   | <b>Giertz-Stille</b> , rib shears .....                   | 96       | atraumatic bronchus forceps, titanium .....             | 126         |
| vascular clamps, titanium .....                       | 141               | <b>Gil-Vernet</b> , vessel and wound hooks .....          | 48       | <b>Leksell</b> , bone rongeur forceps .....             | 72          |
| <b>De Bakey-Diethrich</b> , atraumatic bulldog        |                   | <b>Gillies</b> , tissue forceps, titanium .....           | 46       | <b>Leland-Jones</b> , atraumatic clamps .....           | 121         |
| clamps .....  | 115               | tissue forceps .....                                      | 46       | <b>Lemmon</b> , needle holders .....                    | 87          |
| atraumatic dressing forceps .....                     | 113               | <b>Glover</b> , anastomosis clamps .....                  | 120      | <b>Leriche</b> , hemostatic forceps, titanium .....     | 25          |
| <b>De Bakey-Gerald</b> , atraumatic dressing          |                   | atraumatic anastomosis clamps .....                       | 129, 135 | hemostatic forceps .....                                | 25          |
| forceps .....   | 113               | atraumatic bulldog clamps .....                           | 116, 145 | <b>Lexer</b> , scissors, Supercut TC .....              | 5           |
| <b>De Bakey-Pean</b> , atraumatic hemostatic          |                   | <b>Gluck</b> , rib shears .....                           | 96       | scissors, TC .....                                      | 5           |
| forceps .....   | 137               | Grasping forceps .....                                    | 45       | <b>Lichtenberg</b> , needle holders .....               | 88          |
| <b>De Bakey-Rankin</b> , atraumatic multi             |                   | <b>Gregory</b> , atraumatic profunda clamps .....         | 139      | Ligature scissors, TC .....                             | 4           |
| purpose forceps .....                                 | 138               | <b>Gregory-Soft</b> , atraumatic bulldog clamps .....     | 117      | <b>Liston</b> , bone cutting forceps .....              | 73          |
| <b>De Bakey-Satinsky</b> , atraumatic bulldog         |                   | <b>Haight</b> , rib spreaders .....                       | 102      | <b>Liston-Key</b> , bone cutting forceps .....          | 74          |
| clamps .....  | 116               | <b>Halle</b> , vessel spatulas .....                      | 61       | <b>Little</b> , vessel and wound hooks .....            | 48          |
| <b>De Bakey-Semb</b> , atraumatic ligature            |                   | <b>Halsey</b> , needle holders, titanium .....            | 85       | <b>Love (Morse)</b> , vessel and wound hooks .....      | 48          |
| clamps .....  | 128               | needle holders .....                                      | 85       | <b>Lovelace</b> , lung grasping forceps .....           | 110         |
| <b>Deaver</b> , lung spatulas .....                   | 52                | <b>Halsted-Mosquito</b> , hemostatic forceps,             |          | Lung grasping forceps .....                             | 46, 110     |
| retractors .....                                      | 52, 53            | titanium .....  | 25       | spatulas .....  | 52 – 54, 56 |
| <b>Derra-De Bakey</b> , atraumatic anastomosis        |                   | <b>Harken</b> , auricle clamps .....                      | 125      | <b>Markwalder</b> , bone cutting forceps .....          | 73          |
| clamps, titanium .....                                | 139               | blood vessel clamps .....                                 | 111      | <b>Martin</b> , retractors .....                        | 51          |
| <b>Desmarres</b> , vessel and wound                   |                   | <b>Harrington</b> , dissecting and ligature               |          | <b>Masson</b> , needle holders .....                    | 87          |
| retractors .....                                      | 49                | forceps .....   | 29       | <b>Mathieu-Kocher</b> , needle holders .....            | 88          |
| <b>Dick</b> , atraumatic anastomosis clamps .....     | 134               | retractors .....  | 53       | <b>Matson</b> , periosteal raspatories .....            | 68          |
| <b>Diethrich</b> , atraumatic aortic clamps .....     | 124               | <b>Harrington-Baby</b> , retractors .....                 | 53       | <b>Mayo</b> , ligature scissors .....                   | 4           |
| bulldog clamps .....                                  | 35                | <b>Harrington-Pemberton</b> , retractors .....            | 53       | lung grasping forceps .....                             | 46          |
| hemostatic forceps .....                              | 27                | <b>Hartmann</b> , hemostatic forceps, titanium .....      | 26       | scissors, TC .....                                      | 5           |
| needle holders .....                                  | 90                | hemostatic forceps .....                                  | 26       | scissors .....  | 5           |
| Dissecting and ligature clamps .....                  | 26, 27,           | <b>Harvey</b> , wire scissors .....                       | 76       | <b>Mayo-Hegar</b> , needle holders, titanium .....      | 83, 84      |
| .....   | 29 – 34, 110, 120 | <b>Hegar-Vascular</b> , needle holders .....              | 86       | needle holders .....                                    | 83          |
| Dissecting scissors .....                             | 5 – 8             | <b>Hegemann</b> , vascular scissors .....                 | 14       | <b>Mc Indoe</b> , bone cutting forceps .....            | 73          |
| <b>Doyen</b> , periosteal raspatories .....           | 69                | <b>Heiss</b> , dissecting and ligature forceps .....      | 31       | dressing forceps, titanium .....                        | 43          |
| Dressing and tissue forceps .....                     | 42 – 46           | Hemostatic forceps .....                                  | 24 – 28  | dressing forceps .....                                  | 43          |
| Dressing forceps, titanium .....                      | 25, 26, 28        | <b>Henly</b> , subclavian artery clamps .....             | 131      | micro-grip forceps .....                                | 42          |
| Dressing forceps .....                                | 43 – 45           | <b>Hepp-Scheidt</b> , needle holders .....                | 90       | <b>Mercedes</b> , thoracic spreaders .....              | 104         |
| <b>Duval</b> , tissue and organ grasping              |                   | Inserts for vessel clamps .....                           | 158      | <b>Metzenbaum</b> , dissecting scissors, TC .....       | 6 – 8       |
| forceps .....   | 93                | Irrigation cannulas .....                                 | 59       | dissecting scissors, TC, Supercut .....                 | 8           |
| <b>Echlin</b> , bone rongeur forceps .....            | 72                | <b>Ima</b> , micro-grip forceps .....                     | 42       | dissecting scissors .....                               | 6 – 8       |
| Embolus grasping forceps .....                        | 63                | micro-grip forceps, titanium .....                        | 42       | ligature scissors .....                                 | 4           |
| Enderterectomy scissors, Supercut .....               | 11                | <b>Jacobson</b> , vascular scissors, titanium .....       | 16       | <b>Metzenbaum-Fino</b> , dissecting scissors .....      | 6, 7        |
| strippers .....                                       | 59                | vascular scissors .....                                   | 16       | dissecting scissors, TC .....                           | 6, 7        |
| <b>Eufuate-Pasque</b> , needle holders .....          | 87                | micro-grip needle holders .....                           | 80       | Micro dressing forceps .....                            | 43, 44      |
| <b>Favaloro</b> , vascular scissors .....             | 10                | needle holders .....                                      | 90       | Micro forceps .....                                     | 43, 44      |
| <b>Fergusson</b> , bone holding forceps .....         | 70                | <b>Jacobson-Adson</b> , hemostatic forceps .....          | 27       | needle holders, titanium .....                          | 83          |
| suction tubes .....                                   | 65                | <b>Jacobson-Halsted</b> , hemostatic forceps .....        | 25       | needle holders .....                                    | 82, 83      |
| Fine scissors, Supercut .....                         | 9                 | <b>Jameson-Werber</b> , scissors .....                    | 9        | phlebextractors .....                                   | 59          |
| Fine scissors .....                                   | 9                 | <b>Javid</b> , carotid clamps .....                       | 144      | scissors, titanium .....                                | 19, 20      |
| <b>Finocchietto</b> , needle holders .....            | 88                | <b>Jorgensen</b> , vascular scissors .....                | 13       | scissors .....  | 17 – 20     |
| rib spreaders .....                                   | 101, 105, 107     | <b>Joseph</b> , scissors .....                            | 9        | spatulas .....  | 59          |
| <b>Finocchietto-Baby</b> , rib spreaders .....        | 100               | <b>Kader</b> , retractors .....                           | 53       | suture tying forceps .....                              | 45          |
| <b>Finocchietto-Baby-Haight</b> , rib spreaders ..... | 107               | <b>Kalt</b> , needle holders .....                        | 89       | vascular clamps for prematures .....                    | 142         |
| <b>Finocchietto-Burford</b> , rib spreaders .....     | 101               | <b>Kantrowitz</b> , dissecting and ligature forceps ..... | 29       | vessel clamps .....                                     | 37          |
| <b>Finocchietto-Mini</b> , rib spreaders .....        | 100               | <b>Kelly</b> , retractors .....                           | 51       | vessel clips .....                                      | 38, 39      |
| Forceps, applying .....                               | 37 – 39           | scissors .....  | 8        | <b>Micro-Mosquito</b> , hemostatic forceps .....        | 26          |
| atraumatic dressing .....                             | 113, 114          | <b>Klingenberg-Loth</b> , vascular scissors TC .....      | 13       | hemostatic forceps, titanium .....                      | 26          |
| atraumatic hemostatic .....                           | 137               | vascular scissors .....                                   | 13       | <b>Micro-Ryder</b> , needle holders, titanium .....     | 86          |
| dressing .....  | 43, 45            | <b>Kocher</b> , hemostatic forceps .....                  | 24       | needle holders .....                                    | 86          |
| grasping .....  | 45                | retractors .....  | 50       | Micro-grip dressing forceps .....                       | 42          |
| hemostatic .....                                      | 24 – 28           | <b>Kocher-Langenbeck</b> , retractors .....               | 50       | forceps .....   | 42          |
| lung grasping .....                                   | 46                | <b>Krayenbühl</b> , vessel hooks .....                    | 61       | needle holders .....                                    | 80, 81      |
| micro suture tying .....                              | 45                | <b>König</b> , vessel and wound hooks .....               | 49       | ring forceps .....                                      | 42          |
| micro-grip .....                                      | 42                | <b>Lahey (Sweet)</b> , dissecting and ligature            |          | <b>Microvascular</b> , micro-grip needle holders .....  | 81          |
| micro .....   | 43, 44            | forceps .....   | 34       | <b>Microvascular</b> , needle holders .....             | 86          |
| ring .....  | 42                | <b>Lambert-Kay</b> , atraumatic aorta anastomosis         |          | <b>Mikulicz</b> , retractors .....                      | 51          |
| Forceps, tissue .....                                 | 46                | clamps, titanium .....                                    | 130      | <b>Millesi</b> , micro scissors .....                   | 18          |
| titanium .....  | 43, 44, 46        | <b>Lambert-Kay</b> , atraumatic aorta                     |          | <b>Mills</b> , vascular scissors .....                  | 21          |
| tumor grasping .....                                  | 44                | anastomosis clamps .....                                  | 130      | <b>Mini-Gemini</b> , dissecting and ligature            |             |
| Forceps .....   | 24 – 39           | <b>Lambotte</b> , periosteal raspatories .....            | 68       | forceps .....   | 32          |
| <b>Frazier</b> , suction tubes .....                  | 65                | <b>Langenbeck</b> , bone holding forceps .....            | 70       | Mini-phlebextractors .....                              | 59          |

|   |                           |  |   |   |          |
|---|---------------------------|--|---|---|----------|
| <b>Mixer O'Shaugnessy</b> , dissecting and ligature forceps .....       | 33                        | vessel suction cannulas .....                                | 59  | stripper set .....  | 58       |
| <b>Mixer</b> , dissecting and ligature forceps .....                    | 33                        | <b>Schwartz</b> , clip applying forceps .....                | 35  | strippers .....   | 58       |
| <b>Morris-De Bakey</b> , atraumatic aorta anastomosis clamps .....      | 135                       | Scissors, Supercut .....                                     | 11  | Vessel and wound retractors .....                         | 48, 49   |
| <b>Morse</b> , rib spreaders .....                                      | 106                       | coronary .....   | 10  | clamps with interchangeable jaw inserts .....             | 158      |
| <b>Morse-Favaloro</b> , rib spreaders .....                             | 104, 106                  | dissecting, Supercut TC .....                                | 5   | clamps .....  | 110, 111 |
| <b>Mosquito</b> , atrauma hemostatic forceps .....                      | 137                       | dissecting, TC .....   | 5, 8  | clips .....   | 36 – 39  |
| Multi purpose clamps .....  | 133, 138, 147             | dissecting .....   | 5 – 8   | dilators .....  | 63, 64   |
| <b>Myers</b> , vein strippers .....                                     | 58                        | endarterectomy, Supercut .....                               | 11  | hooks .....   | 61       |
| <b>Müller</b> , approximators .....                                     | 39                        | fine, Supercut .....   | 9   | instruments .....   | 58 – 66  |
| vessel clips .....  | 38                        | fine .....   | 9   | spatulas .....  | 60, 61   |
| <b>Nabatoff</b> , vein stripper set .....                               | 58                        | ligature, TC .....   | 4   | suction tubes .....                                       | 59       |
| Needle holders .....  | 80 – 90                   | micro, titanium .....  | 19, 20  | <b>Volkmann</b> , retractors .....                        | 50       |
| <b>Nelson</b> , grasping forceps .....                                  | 46                        | micro .....  | 17 – 20   | <b>Wangensteen</b> , dressing forceps .....               | 45       |
| Neonatal clamps .....   | 157                       | operating TC .....   | 2, 3  | needle holders .....                                      | 87       |
| instrument set .....  | 143, 156                  | operating .....  | 2, 3, 8   | <b>Weber</b> , atraumatic aorta clamps .....              | 128      |
| rib spreaders, titanium .....   | 108                       | titanium .....   | 15, 16, 19, 20  | <b>Weitlaner</b> , retractors .....                       | 55, 56   |
| <b>Ochsner</b> , atraumatic aorta clamps .....                          | 124                       | vascular, titanium .....                                     | 15, 16  | <b>Wertheim</b> , atrauma anastomosis clamps .....        | 134      |
| <b>Ochsner-Kocher</b> , hemostatic forceps .....                        | 24                        | vascular .....   | 10, 12 – 16, 21   | <b>Wickstroem</b> , dissecting and ligature forceps ..... | 34       |
| Operating scissors, TC .....  | 2, 3                      | vein .....   | 18  | <b>Williams</b> , tissue and organ grasping forceps ..... | 92       |
| scissors .....  | 2, 3, 8                   | Scissors .....   | 2 – 21  | Wire cutting pliers .....                                 | 76 – 78  |
| <b>Overholt</b> , dissecting and ligature forceps .....                 | 30                        | Self-retaining retractors .....                              | 55, 56  | scissors .....  | 76       |
| <b>Overholt-Geissendörfer</b> , dissecting and ligature forceps .....   | 31                        | <b>Sellors</b> , rib contractors .....                       | 108   | <b>Wylie</b> , atraumatic vessel clamps .....             | 123      |
| <b>Overholt-Mixer</b> , dissecting and ligature forceps .....           | 31                        | <b>Semb</b> , bone cutting forceps .....                     | 74  | <b>Yankauer</b> , suction tubes .....                     | 65       |
| <b>Overholt-Slim</b> , dissecting and ligature forceps .....            | 30                        | bone holding forceps .....                                   | 70  | <b>Zenker</b> , retractors .....                          | 53       |
| <b>Pean</b> , hemostatic forceps .....                                  | 24                        | bone rongeur forceps .....                                   | 71  | <b>Zweifel</b> , needle holders .....                     | 88       |
| Pediatric clamps .....  | 141 – 143, 152, 154 – 157 | dissecting and ligature forceps .....                        | 110   |   |          |
| Periosteal raspatories .....  | 68, 69                    | periosteal raspatories .....                                 | 69  |   |          |
| vascular clamps .....   | 139                       | Setting forceps .....  | 115   |   |          |
| Phlebotomizers .....  | 59                        | Silicone tapes for metal cases .....                         | 160   |   |          |
| Phleboextractors .....  | 59                        | <b>Simon</b> , retractors .....                              | 51  |   |          |
| Phlebectomy Hooks .....   | 60                        | <b>Singley-Tuttle</b> , grasping forceps .....               | 46  |   |          |
| <b>Potts</b> , atraumatic clamps .....                                  | 119                       | Sterilizing cases .....                                      | 64  |   |          |
| atraumatic coarctation clamps .....                                     | 119                       | Sternum scissors .....                                       | 96  |   |          |
| coarctation clamps .....  | 119                       | <b>Stille</b> , bone rongeur forceps .....                   | 72  |   |          |
| <b>Potts-De Martel</b> , vascular scissors .....                        | 21                        | rib scissors .....   | 96  |   |          |
| <b>Potts-Smith</b> , dressing forceps .....                             | 45                        | <b>Stille-Liston</b> , bone cutting forceps .....            | 74  |   |          |
| vascular scissors, Supercut .....                                       | 11                        | <b>Stille-Luer</b> , bone rongeur forceps .....              | 71  |   |          |
| vascular scissors, TC .....   | 12                        | <b>Stille-Ruskin</b> , bone rongeur forceps .....            | 71  |   |          |
| vascular scissors .....   | 10, 12, 13                | <b>Struck</b> , rib spreaders .....                          | 100   |   |          |
| <b>Price-Thomas</b> , bronchus forceps .....                            | 110                       | <b>Strully</b> , vascular scissors .....                     | 21  |   |          |
| Profunda clamps .....   | 139                       | <b>Subclavia</b> , hemostatic forceps .....                  | 131   |   |          |
| Ratchet lock .....  | 119                       | <b>Subramanian-Miniature</b> , atraumatic aorta clamps ..... | 139   |   |          |
| Retractors .....  | 48 – 54                   | atraumatic clamps, titanium .....                            | 139   |   |          |
| <b>Reynolds</b> , scissors, Supercut .....                              | 9                         | Suction cannulas .....                                       | 65  |   |          |
| scissors .....  | 9                         | tubes .....  | 66  |   |          |
| Rib contractors .....   | 108                       | Tangential occlusion clamps .....                            | 129, 151  |   |          |
| Rib scissors .....  | 96, 97                    | Thoracic spreaders .....                                     | 104   |   |          |
| Rib spreaders .....   | 100 – 108                 | Tissue and organ grasping forceps .....                      | 92, 93  |   |          |
| <b>Rienhoff-Finocchietto</b> , rib spreaders .....                      | 102                       | Tissue forceps .....   | 46  |   |          |
| Ring forceps .....  | 42                        | Titanium atraumatic bulldog clamps .....                     | 118   |   |          |
| <b>Rochester-Pean</b> , hemostatic forceps .....                        | 24                        | atraumatic clamps .....                                      | 119 – 122, 126, 128 – 131, 139, 141, 142, 146, 147, 151 |   |          |
| <b>Ross</b> , retractors .....  | 54                        | clamps .....   | 25, 26, 28  |   |          |
| <b>Rudolf</b> , needle holders .....                                    | 86                        | dressing forceps .....                                       | 43, 44, 46  |   |          |
| <b>Rumel</b> , dissecting and ligature forceps .....                    | 29                        | needle holders .....   | 83 – 86, 89   |   |          |
| <b>Rumel-Belmont</b> , tourniquets .....                                | 66                        | rib spreaders .....  | 108   |   |          |
| <b>Ruskin-Liston</b> , bone cutting forceps .....                       | 74                        | scissors .....   | 15, 16, 19, 20  |   |          |
| <b>Ryder</b> , micro-grip needle holders .....                          | 81                        | <b>Toennis</b> , vessel spatulas .....                       | 60  |   |          |
| needle holders .....  | 86                        | Tourniquets .....  | 66  |   |          |
| <b>Santulli</b> , atraumatic bulldog clamps .....                       | 117                       | <b>Tubbs</b> , aorta dilators .....                          | 62  |   |          |
| <b>Sarot</b> , hemostatic forceps .....                                 | 28                        | Tumor grasping forceps .....                                 | 44  |   |          |
| needle holders .....  | 87                        | <b>Tönnis</b> , needle holders .....                         | 88  |   |          |
| <b>Satinsky</b> , vessel clamps .....                                   | 111                       | <b>Tönnis-Adson</b> , vascular scissors, TC .....            | 13  |   |          |
| vessel scissors .....   | 13                        | <b>Universal</b> , wire scissors .....                       | 76  |   |          |
| <b>Satinsky/De Bakey</b> , atraumatic tangential occlusion clamps ..... | 129                       | <b>Varady</b> , micro phlebextractors .....                  | 59  |   |          |
| <b>Sauerbruch</b> , bone rongeur forceps .....                          | 72                        | micro spatula .....  | 59  |   |          |
| retractors .....  | 52                        | <b>Varady</b> , mini phlebextractors .....                   | 59  |   |          |
| rib scissors .....  | 96                        | phlebotomizers .....   | 59  |   |          |
| <b>Sawtell</b> , dissecting and ligature forceps .....                  | 33                        | phleboextractors .....                                       | 59  |   |          |
| <b>Schmid</b> , vessel spatulas .....                                   | 60                        | Varix instruments .....                                      | 59  |   |          |
|   |                           | Vascular scissors, TC .....                                  | 12 – 14   |   |          |
|   |                           | Vascular scissors, titanium .....                            | 15, 16  |   |          |
|   |                           | scissors .....   | 10, 12 – 16, 21   |   |          |
|   |                           | Vein scissors .....  | 18  |   |          |

# Indice



|  |                               |  |                         |   |                         |
|--|-------------------------------|--|-------------------------|---|-------------------------|
| <b>Acland Mod.</b> , micro-pinzas vasculares .....                           | 37                            | periféricas .....  | 139                     | dilatadores de aorta .....  | 62                      |
| <b>Adson</b> , pinzas „Micro-Grip“ .....                                     | 42                            | pinzas-clamps .....  | 119 – 157               | juego de instrumental para recién nacidos .....                                       | 156                     |
| pinzas de disección atrauma .....  | 113                           | <b>Babcock</b> , pinzas para coger tejidos y órganos .....         | 93                      | pinzas-clamps para carotis .....  | 144                     |
| pinzas de disección con dientes .....  | 46                            | <b>Babcock-Atrauma</b> , pinzas para coger tejidos y órganos ..... | 93                      | separadores .....   | 54                      |
| pinzas de disección con dientes de titanio .....                             | 46                            | <b>Baby-Adson</b> , pinzas hemostáticas .....                      | 26                      | separadores costales .....  | 102, 105                |
| pinzas de disección sin dientes .....  | 43                            | <b>Baby-Crile-Wood</b> , porta-agujas .....                        | 85                      | separadores para aurícula .....   | 54                      |
| pinzas de disección sin dientes de titanio .....                             | 43                            | <b>Baby-Hegemann</b> , tijeras vasculares .....                    | 14                      | <b>Cooley-Derra</b> , atrauma pinzas-clamps vasculares .....                          | 151                     |
| pinzas hemostáticas .....  | 26                            | <b>Baby-Mixer</b> , pinzas para preparaciones y ligaduras .....    | 32                      | Coronarias, pinzas-clamps para arterias .....   | 33                      |
| separadores .....  | 55                            | <b>Baby-Satinsky</b> , pinzas-clamps vasculares .....              | 111                     | tijeras .....   | 10                      |
| <b>Adson-Brown</b> , pinzas de disección con dientes .....                   | 46                            | <b>Bailey</b> , aproximadores para costillas .....                 | 108                     | <b>Coryllos</b> , separadores .....   | 52                      |
| pinzas de disección con dientes de titanio .....                             | 46                            | <b>Bailey-Baby</b> , aproximadores para costillas .....            | 108                     | Costótomos .....  | 96, 97                  |
| <b>Alexander</b> , periostótomos .....                                       | 68                            | <b>Bailey-Gibbon</b> , aproximadores para costillas .....          | 108                     | <b>Crafoord</b> , pinzas hemostáticas .....   | 28                      |
| Alicates para alambre con corte lateral .....                                | 78                            | <b>Barraquer</b> , porta-agujas .....                              | 90                      | pinzas hemostáticas de titanio .....  | 28                      |
| Alicates para alambre con corte lateral y frontal .....                      | 78                            | <b>Beck</b> , atrauma pinzas-clamps vasculares .....               | 130, 150                | <b>Crafoord-Sellers</b> , pinzas para aorta .....                                     | 28                      |
| Alicates para cortar alambre .....   | 76 – 78                       | <b>Beck</b> , atrauma pinzas-clamps vasculares de titanio .....    | 130                     | <b>Crawford</b> , separadores .....   | 51                      |
| <b>Allis-Atrauma</b> , pinzas para coger tejidos y órganos .....             | 93                            | <b>Bengolea</b> , pinzas hemostáticas .....                        | 27                      | <b>Crile</b> , ganchitos vasculares .....   | 61                      |
| <b>Allison</b> , espátulas pulmonares .....                                  | 56                            | <b>Bethune</b> , costótomos .....                                  | 97                      | <b>Crile-Wood</b> , porta-agujas .....  | 85                      |
| <b>Alm</b> , separadores .....   | 55                            | <b>Biemer</b> , micro-clips vasculares .....                       | 39                      | <b>Cushing</b> , ganchitos vasculares .....   | 61                      |
| Anillos, pinzas de disección con .....                                       | 42                            | <b>Biemer-Müller</b> , micro-aproximadores .....                   | 39                      | ganchos vasculares .....  | 48                      |
| Aorta, pinzas para .....   | 28                            | <b>Blake</b> , pinzas para coger émbolos .....                     | 63                      | pinzas de disección sin dientes .....   | 45                      |
| Aplicar clips, pinzas para .....   | 37 – 39                       | <b>Bocas</b> para pinzas-clamps vasculares .....                   | 158                     | <b>Cushing-Kocher</b> , ganchos vasculares .....                                      | 49                      |
| Aproximadores para costillas .....   | 108                           | <b>Borowski</b> , ganchos para aorta .....                         | 54                      | Cánulas de aspiración .....   | 65                      |
| Aproximadores .....  | 37, 39                        | <b>Bozemann</b> , porta-agujas .....                               | 83                      | de irrigación .....   | 59                      |
| Atrauma clamps Bulldog.. 115 – 118, 145, 153 clamps Bulldog de titanio ..... | 118                           | <b>Bridge</b> , pinzas hemostáticas .....                          | 28                      | de irrigación para vasos .....  | 59                      |
| micro-pinzas-clamps vasculares .....   | 142                           | <b>Bruner</b> , tijeras de esternón .....                          | 97                      | <b>Dale</b> , atrauma pinzas-clamps vasculares periféricos .....                      | 139                     |
| pinzas de disección .....  | 113, 114                      | <b>Burford</b> , separadores costales .....                        | 107                     | <b>Dale</b> , pinzas-gubias .....   | 72                      |
| pinzas de disección de titanio .....   | 113                           | <b>Böhler</b> , pinzas cortantes para huesos .....                 | 73                      | <b>Dardik</b> , atrauma pinzas-clamps vasculares .....                                | 132                     |
| pinzas hemostáticas .....  | 137                           | Carotis, pinzas-clamps para .....                                  | 144                     | <b>Davidson</b> , separadores .....   | 54                      |
| pinzas para subclavia .....  | 131                           | <b>Castaneda</b> , pinzas-clamps para recién nacidos .....         | 157                     | <b>Davidson-Alexander</b> , periostótomos .....                                       | 68                      |
| pinzas-clamps auriculares .....  | 125                           | separadores costales .....   | 106                     | <b>Davis</b> , espátulas vasculares .....   | 60                      |
| pinzas-clamps bronquiales .....  | 126                           | <b>Castroviejo</b> , porta-agujas .....                            | 89, 90                  | <b>De Bakey</b> , atrauma clamps Bulldog.. 116, 117 atrauma pinzas de disección ..... | 113, 114                |
| pinzas-clamps bronquiales de titanio .....                                   | 126                           | porta-agujas „Micro-Grip“ .....                                    | 80                      | atrauma pinzas de disección de titanio .....  | 113, 114                |
| pinzas-clamps cardiovasculares .....   | 141                           | porta-agujas de titanio .....                                      | 89                      | atrauma pinzas hemostáticas .....   | 137                     |
| pinzas-clamps cardiovasculares de titanio .....                              | 141                           | Cierre de seguridad .....  | 119                     | atrauma pinzas-clamps para aneurisma .....  | 122                     |
| pinzas-clamps para anastomosis .....   | 120, 129, 134, 135, 139, 149  | Cintas de silicona .....   | 160                     | atrauma pinzas-clamps para aneurisma de aorta .....                                   | 122, 123                |
| pinzas-clamps para anastomosis de aorta .....                                | 130, 135                      | Cizallas para cortar alambre .....                                 | 76                      | atrauma pinzas-clamps para aneurisma de aorta de titanio .....                        | 122                     |
| pinzas-clamps para anastomosis de titanio .....                              | 130                           | Clamps Bulldog .....   | 36, 115 – 118, 145, 153 | atrauma pinzas-clamps para aorta .....  | 127                     |
| pinzas-clamps para aneurisma de aorta .....                                  | 122, 123, 136                 | Bulldog, atrauma .....   | 115 – 118, 145, 153     | atrauma pinzas-clamps vasculares .....  | 121, 130, 131, 138, 140 |
| pinzas-clamps para aorta .....   | 124, 127, 128, 139            | vasculares, micro .....  | 37                      | atrauma pinzas-clamps para ligadura .....   | 127                     |
| pinzas-clamps para coarctación .....   | 119, 136, 146                 | <b>Cleveland</b> , pinzas cortantes para huesos .....              | 73                      | atrauma pinzas-clamps de usos varios .....  | 133                     |
| pinzas-clamps para coarctación de titanio .....                              | 146                           | Clips vasculares .....   | 35, 37 – 39             | atrauma pinzas-clamps para preparaciones y ligaduras .....                            | 120                     |
| pinzas-clamps para ligadura .....  | 128                           | Coarctación, pinzas-clamps para .....                              | 115, 136, 146           | cánulas de aspiración .....   | 65                      |
| pinzas-clamps para oclusión tangencial .....                                 | 129, 151                      | <b>Collin</b> , costótomos .....                                   | 96                      | dilatadores vasculares .....  | 63                      |
| pinzas-clamps para oclusión tangencial de titanio .....                      | 129                           | <b>Cone</b> , separadores .....                                    | 55                      | juego de instrumental para recién nacidos .....                                       | 143                     |
| pinzas-clamps para preparaciones y ligaduras .....                           | 120                           | <b>Converse</b> , porta-agujas .....                               | 85                      | porta-agujas „Micro-Grip“ .....   | 81                      |
| pinzas-clamps para usos varios .....   | 133, 138, 147                 | <b>Cooley</b> , atrauma clamps Bulldog .....                       | 145, 153                | porta-agujas .....  | 84, 85                  |
| pinzas-clamps para usos varios de titanio .....                              | 147                           | atrauma pinzas de disección .....                                  | 113                     | porta-agujas de titanio .....   | 84                      |
| pinzas-clamps pediátricos .....  | 141 – 143, 152, 154 – 157     | atrauma pinzas-clamps para anastomosis .....                       | 149                     | separadores costales .....  | 103                     |
| pinzas-clamps profundales .....  | 139                           | atrauma pinzas-clamps para coarctación .....                       | 146                     | tijeras vasculares .....  | 10, 14                  |
| pinzas-clamps profundales de titanio .....                                   | 139                           | atrauma pinzas-clamps para coarctación de titanio .....            | 146                     | <b>De Bakey-Bahnson</b> , atrauma pinzas-clamps para aneurisma de aorta .....         | 136                     |
| pinzas-clamps vasculares .....   | 131, 132, 138, 140, 148 – 151 | atrauma pinzas-clamps vasculares .....                             | 138, 148 – 150          | <b>De Bakey-Bainbridge</b> , atrauma pinzas-clamps vasculares .....                   | 121                     |
| pinzas-clamps vasculares de titanio .....                                    | 130                           | atrauma pinzas-clamps para ligadura de titanio .....               | 151                     | <b>De Bakey-Beck</b> , atrauma pinzas-clamps vasculares .....                         | 131                     |
| Atrauma pinzas-clamps vasculares .....                                       |                               | atrauma pinzas-clamps pediátricos .....                            | 152                     | <b>De Bakey-Castaneda</b> , atrauma pinzas-clamps vasculares de titanio .....         | 141                     |
|  |                               | atrauma pinzas-clamps para usos varios .....                       | 147                     | <b>De Bakey-Diethrich</b> , atrauma clamps Bulldog .....                              | 115                     |
|  |                               | atrauma pinzas-clamps para usos varios de titanio .....            | 147                     | <b>De Bakey-Diethrich</b> , atrauma pinzas de disección .....                         | 113                     |
|  |                               | atrauma pinzas-clamps para oclusión tangencial .....               | 151                     |   |                         |
|  |                               | <b>Cooley</b> , cánulas de aspiración .....                        | 66                      |   |                         |

## Indice

|  |             |   |          |   |          |
|--|-------------|---|----------|---|----------|
| <b>De Bakey-Gerald</b> , atrauma pinzas de disección.....  | 113         | <b>Gregory</b> , atrauma pinzas-clamps profundales.....                           | 139      | atrauma pinzas-clamps bronquiales de titanio.....                               | 126      |
| <b>De Bakey-Rankin</b> , atrauma pinzas-clamps de varios usos.....                               | 138         | <b>Gregory-Soft</b> , atrauma clamps Bulldog.....                                 | 117      | <b>Leksel</b> , pinzas-gubias.....  | 72       |
| <b>De Bakey-Satinsky</b> , atrauma clamps Bulldog.....   | 116         | <b>Haight</b> , separadores costales.....   | 102      | <b>Leland-Jones</b> , atrauma pinzas-clamps.....                                | 121      |
| <b>De Bakey-Semb</b> , atrauma pinzas-clamps para ligaduras.....                                 | 128         | <b>Halle</b> , espátulas vasculares.....  | 61       | <b>Lemmon</b> , porta-agujas.....   | 87       |
| <b>Deaver</b> , espátulas pulmonares separadores.....  | 52, 53      | <b>Halsey</b> , porta-agujas.....   | 85       | <b>Lerliche</b> , pinzas hemostáticas pinzas hemostáticas de titanio.....       | 25       |
| <b>Derra-De Bakey</b> , atrauma pinzas-clamps para anastomosis de titanio.....                   | 139         | porta-agujas de titanio.....  | 85       | <b>Lexer</b> , tijeras, Supercut, TC.....                                       | 5        |
| <b>Desmarres</b> , ganchos vasculares.....   | 49          | <b>Halsted-Mosquito</b> , pinzas hemostáticas pinzas hemostáticas de titanio..... | 25       | tijeras, TC.....  | 5        |
| <b>Dick</b> , atrauma pinzas-clamps para anastomosis.....  | 134         | <b>Harken</b> , atrauma pinzas-clamps auriculares.....                            | 125      | <b>Lichtenberg</b> , porta-agujas Ligaduras, tijeras TC.....                    | 88       |
| <b>Diethrich</b> , atrauma pinzas-clamps para aorta.....   | 124         | pinzas-clamps vasculares.....   | 111      | <b>Liston</b> , pinzas cortantes para huesos.....                               | 73       |
| clamps Bulldog.....  | 36          | <b>Harrington</b> , pinzas para preparaciones y ligaduras.....                    | 29       | <b>Liston-Key</b> , pinzas cortantes para huesos.....                           | 74       |
| pinzas hemostáticas.....   | 27          | <b>Harrington</b> , separadores.....  | 53       | <b>Little</b> , ganchos vasculares.....   | 48       |
| porta-agujas.....  | 90          | <b>Harrington-Baby</b> , separadores.....   | 53       | <b>Love (Morse)</b> , ganchos vasculares.....                                   | 48       |
| Dilatadores de aorta.....  | 62          | <b>Harrington-Pemberton</b> , separadores.....                                    | 53       | <b>Lovelace</b> , pinzas-clamps pulmonares.....                                 | 110      |
| vasculares.....  | 63, 64      | <b>Hartmann</b> , pinzas hemostáticas pinzas hemostáticas de titanio.....         | 26       | <b>Markwalder</b> , pinzas cortantes para huesos.....                           | 73       |
| Disección, pinzas de.....  | 42 - 46     | <b>Hartmann</b> , pinzas hemostáticas de titanio.....                             | 26       | <b>Martin</b> , separadores.....  | 51       |
| Disectores para venas.....   | 59          | <b>Harvey</b> , cizallas para cortar alambre.....                                 | 76       | <b>Masson</b> , porta-agujas.....   | 87       |
| <b>Doyen</b> , periostótomos.....  | 69          | <b>Hegar-Vascular</b> , porta-agujas.....   | 86       | <b>Mathieu-Kocher</b> , porta-agujas.....                                       | 88       |
| <b>Duval</b> , pinzas para coger tejidos y órganos.....  | 92          | <b>Hegemann</b> , tijeras vasculares.....   | 14       | <b>Matson</b> , periostótomos.....  | 68       |
| <b>Echlin</b> , pinzas-gubias.....   | 72          | <b>Heiss</b> , pinzas para preparaciones y ligaduras.....                         | 31       | <b>Mayo</b> , pinzas para coger pulmones tijeras para ligaduras.....            | 46       |
| <b>Embolos</b> , pinzas para.....  | 63          | <b>Henly</b> , atrauma pinzas-clamps para subclavia.....                          | 131      | tijeras.....  | 4        |
| Endarterectomia, tijeras para.....   | 11          | <b>Hepp-Scheidel</b> , porta-agujas.....  | 90       | tijeras, TC.....  | 5        |
| Espátulas pulmonares.....  | 52 - 54, 56 | <b>Hepp-Scheidel</b> , porta-agujas.....  | 90       | <b>Mayo-Hegar</b> , porta-agujas.....   | 83, 84   |
| vasculares.....  | 60, 61      | Hilos para huesos.....  | 76       | porta-agujas de titanio.....  | 83       |
| Esternón, tijeras de.....  | 96, 97      | Instrumental para huesos.....   | 68 - 78  | <b>McIndoe</b> , pinzas cortantes para huesos.....                              | 73       |
| Estuches para clamps Bulldog para esterilización.....  | 64          | Instrumental para várices.....  | 59       | pinzas de disección de titanio.....   | 43       |
| <b>Eufrate-Pasque</b> , porta-agujas.....  | 87          | Instrumental vascular.....  | 58 - 66  | pinzas de disección sin dientes.....  | 43       |
| Extractores para venas.....  | 59          | <b>Ima</b> , pinzas de disección „Micro-Grip“.....                                | 42       | pinzas de disección „Micro-Grip“.....   | 42       |
| <b>Favaloro</b> , tijeras.....   | 10          | <b>Jacobsen</b> , tijeras vasculares tijeras vasculares de titanio.....           | 16       | <b>Mercedes</b> , separadores torácicos.....                                    | 104      |
| <b>Fergusson</b> , cánulas de aspiración pinzas para huesos.....                                 | 65          | porta-agujas.....   | 90       | <b>Metzenbaum</b> , tijeras para ligaduras tijeras para preparaciones.....      | 4        |
| <b>Finocchietto</b> , porta-agujas separadores costales.....                                     | 88          | porta-agujas „Micro-Grip“.....  | 80       | tijeras para preparaciones, Supercut, TC.....                                   | 6 - 8    |
| <b>Finocchietto-Baby</b> , separadores costales.....   | 100         | <b>Jacobson-Adson</b> , pinzas hemostáticas.....                                  | 27       | tijeras para preparaciones, TC.....   | 6 - 8    |
| <b>Finocchietto-Baby-Haight</b> , separadores costales.....                                      | 107         | <b>Jacobson-Halsted</b> , pinzas hemostáticas.....                                | 25       | <b>Metzenbaum-Fino</b> , tijeras para preparaciones.....                        | 6, 7     |
| <b>Finocchietto-Burford</b> , separadores costales.....  | 101         | <b>Jameson-Werber</b> , tijeras.....  | 9        | tijeras para preparaciones, TC.....   | 6, 7     |
| <b>Finocchietto-Mini</b> , separadores costales.....   | 100         | <b>Javid</b> , pinzas-clamps para carotis.....                                    | 144      | <b>Micro-Grip</b> pinzas de anillo.....   | 42       |
| <b>Frazier</b> , cánulas de aspiración.....  | 65          | <b>Jorgensen</b> , tijeras vasculares.....  | 13       | pinzas de disección.....  | 42       |
| <b>Freer</b> , espátulas vasculares.....   | 60          | <b>Joseph</b> , tijeras.....  | 9        | porta-agujas.....   | 80, 81   |
| <b>Frykholm</b> , pinzas-gubias.....   | 72          | Juego de instrumental para recién nacidos.....                                    | 143, 156 | <b>Micro-Mosquito</b> , pinzas hemostáticas pinzas hemostáticas de titanio..... | 26       |
| Ganchitos vasculares.....  | 61          | Juego para várices.....   | 58       | <b>Micro-Ryder</b> , porta-agujas porta-agujas de titanio.....                  | 86       |
| Ganchos para aorta.....  | 54          | <b>Kader</b> , separadores.....   | 53       | porta-agujas de titanio.....  | 86       |
| vasculares.....  | 48, 49      | <b>Kalt</b> , porta-agujas.....   | 89       | Micro-clamps vasculares.....  | 37       |
| y separadores.....   | 48 - 54     | <b>Kantowitz</b> , pinzas para preparaciones y ligaduras.....                     | 29       | Micro-clips vasculares.....   | 38, 39   |
| Ganchos para flebectomia.....  | 60          | <b>Kelly</b> , separadores.....   | 51       | Micro-espátulas, dobles.....  | 59       |
| <b>Garrett</b> , dilatadores vasculares.....   | 64          | tijeras.....  | 8        | Micro-extractores para venas.....   | 59       |
| <b>Gemini</b> , pinzas para preparaciones y ligaduras.....                                       | 32          | <b>Klingenberg-Loth</b> , tijeras vasculares tijeras vasculares, TC.....          | 13       | Micro-pinzas de disección.....  | 43, 44   |
| <b>Gerald</b> , pinzas de disección con dientes pinzas de disección con dientes de titanio.....  | 46          | <b>Kocher</b> , pinzas hemostáticas separadores.....                              | 24       | Micro-pinzas para sutura.....   | 45       |
| pinzas de disección sin dientes.....   | 43          | <b>Kocher-Langenbeck</b> , separadores.....                                       | 50       | Micro-pinzas-clamps cardiovasculares para niños prematuros.....                 | 142      |
| pinzas de disección sin dientes de titanio.....  | 43          | <b>Kragenbühl</b> , ganchitos vasculares.....                                     | 61       | Micro-porta-agujas.....   | 82, 83   |
| <b>Giertz-Stille</b> , costótomos.....   | 96          | <b>König</b> , ganchos vasculares.....  | 49       | Micro-porta-agujas de titanio.....  | 83       |
| <b>Gil-Vernet</b> , ganchos vasculares.....  | 48          | <b>Lahey (Sweet)</b> , pinzas para preparaciones y ligaduras.....                 | 34       | Micro-tijeras.....  | 17 - 20  |
| <b>Gillies</b> , pinzas de disección con dientes pinzas de disección con dientes de titanio..... | 46          | <b>Lambert-Kay</b> , atrauma pinzas-clamps para anastomosis de aorta.....         | 130      | Micro-tijeras de titanio.....   | 19, 20   |
| <b>Glover</b> , atrauma clamps Bulldog.....  | 116, 145    | atrauma pinzas-clamps para anastomosis de aorta de titanio.....                   | 130      | <b>Microvascular</b> , porta-agujas „Micro-Grip“..                              | 81       |
| atrauma pinzas-clamps para anastomosis.....  | 129, 135    | <b>Lambotte</b> , periostótomos.....  | 68       | porta-agujas.....   | 86       |
| <b>Glover</b> , pinzas-clamps para anastomosis.....  | 120         | <b>Langenbeck</b> , periostótomos.....  | 68       | <b>Mikulic</b> , separadores.....   | 51       |
| <b>Gluck</b> , costótomos.....   | 96          | pinzas para huesos.....   | 70       | <b>Millesi</b> , micro-tijeras.....   | 18       |
|  |             | separadores.....  | 50       | <b>Mills</b> , tijeras vasculares.....  | 21       |
|  |             | <b>Langenbeck-Ryder</b> , porta-agujas.....                                       | 88       | <b>Mini-Gemini</b> , pinzas para preparaciones y ligaduras.....                 | 32       |
|  |             | <b>Lawrence</b> , pinzas para preparaciones y ligaduras.....                      | 34       | Mini-extractores para venas.....  | 59       |
|  |             | <b>Lazar</b> , micro-pinzas de disección.....                                     | 45       | <b>Mixer</b> , pinzas para preparaciones y ligaduras.....                       | 33       |
|  |             | <b>Lebsche</b> , cinceles de esternón.....  | 97       | <b>Mixer O'Shaughnessy</b> , pinzas para preparaciones y ligaduras.....         | 33       |
|  |             | <b>Lees</b> , atrauma pinzas-clamps bronquiales.....                              | 126      | <b>Morris-De Bakey</b> , atrauma pinzas-clamps para anastomosis de aorta.....   | 135      |
|  |             |   |          | <b>Morse</b> , separadores costales.....  | 106      |
|  |             |   |          | <b>Morse-Favaloro</b> , separadores costales.....                               | 104, 106 |

# Indice



|  |   |  |
|--|---|--|
| <b>Mosquito</b> , atrauma pinzas hemostáticas .. 137 | -clamps para aorta... 28, 124, 127, 128, 139            | <b>Ryder</b> , porta-agujas „Micro-Grip“ ..... 81        |
| <b>Müller</b> , aproximadores ..... 39               | -clamps para aorta,                                     | porta-agujas ..... 86                                    |
| clips vasculares ..... 38                            | atrauma..... 124, 127, 128, 139                         | <b>Santulli</b> , atrauma clamps Bulldog ..... 117       |
| <b>Myers</b> , sondas para várices ..... 58          | -clamps para aorta de titanio, atrauma .. 139           | <b>Sarot</b> , pinzas hemostáticas ..... 28              |
| <b>Nabatoff</b> , juego para várices ..... 58        | -clamps para carotis ..... 144                          | porta-agujas ..... 87                                    |
| <b>Nelson</b> , pinzas de disección ..... 46         | -clamps para coarctación..... 119, 136, 146             | <b>Satinsky</b> , pinzas-clamps vasculares..... 111      |
| <b>Ochsner</b> , atrauma pinzas clamps para          | -clamps para coarctación,                               | tijeras vasculares ..... 13                              |
| aorta ..... 124                                      | atrauma..... 119, 136, 146                              | <b>Satinsky/De Bakey</b> , atrauma pinzas-               |
| <b>Ochsner-Kocher</b> , pinzas                       | -clamps para coarctación de titanio,                    | clamps para oclusión tangencial..... 129                 |
| hemostáticas..... 24                                 | atrauma..... 146  | <b>Sauerbruch</b> , costótomos ..... 96                  |
| <b>Overholt</b> , pinzas para                        | -clamps para ligadura .... 127, 128, 138, 151           | pinzas-gubias..... 72                                    |
| preparaciones y ligaduras ..... 30                   | -clamps para ligadura de titanio,                       | separadores..... 52                                      |
| <b>Overholt-Geissendörfer</b> , pinzas para          | atrauma..... 128, 151                                   | <b>Sawtell</b> , pinzas para preparaciones y             |
| preparaciones y ligaduras..... 31                    | -clamps para oclusión tangencial,                       | ligaduras ..... 33                                       |
| <b>Overholt-Mixter</b> , pinzas para prepara-        | atrauma..... 129, 151                                   | <b>Schmid</b> , cánulas de irrigación para vasos .. 59   |
| ciones y ligaduras ..... 31                          | -clamps para oclusión tangencial de                     | espátulas vasculares ..... 60                            |
| <b>Overholt-Slim</b> , pinzas para prepara-          | titanio, atrauma ..... 129                              | <b>Schwartz</b> , pinzas para poner clamps..... 36       |
| ciones y ligaduras ..... 30                          | -clamps para preparaciones y ligadura,                  | <b>Sellers</b> , aproximadores para costillas ..... 108  |
| <b>Pean</b> , pinzas hemostáticas ..... 24           | atrauma..... 120  | <b>Semb</b> , periostótomos ..... 69                     |
| Periféricas, pinzas-clamps vasculares..... 139       | -clamps para subclavia, atrauma ..... 131               | pinzas cortantes para huesos..... 74                     |
| Periostótomos..... 68, 69                            | -clamps para usos varios ..... 133, 138, 147            | pinzas para huesos..... 70                               |
| Pinzas ..... 24 – 39                                 | -clamps para usos varios,                               | pinzas para preparaciones y ligaduras .. 110             |
| atraumaticas ..... 113, 114                          | atrauma..... 133, 138, 147                              | pinzas-gubias..... 71                                    |
| cortantes para huesos ..... 73, 74                   | -clamps para usos varios de titanio,                    | Separadores ..... 55, 56                                 |
| de disección ..... 42 – 46                           | atrauma ..... 147                                       | costales ..... 100 – 107                                 |
| de disección „Micro-Grip“ ..... 42                   | -clamps pediátricos..... 141 – 143, 152,                | de esternón para recién nacidos,                         |
| de disección con dientes ..... 46                    | 154 – 157   | de titanio ..... 108                                     |
| de disección de titanio ..... 43, 44, 46             | -clamps pediátricos, atrauma..... 152                   | para aurícula..... 54                                    |
| de disección sin dientes..... 43 – 45                | -clamps pediátricos y para recién                       | para huesos ..... 50                                     |
| de disección, micro..... 43, 44                      | nacidos ..... 154, 155                                  | torácicos ..... 104                                      |
| de disección con anillos..... 42                     | -clamps pediátricos y para recién                       | <b>Simon</b> , separadores..... 51                       |
| de titanio ..... 25, 26, 28                          | nacidos, atrauma ..... 154, 155                         | <b>Singley-Tuttle</b> , pinzas para coger tejidos ... 46 |
| hemostáticas..... 24 – 28                            | -clamps profundales, atrauma ..... 139                  | Sondas para endarterectomia ..... 59                     |
| para aorta ..... 28                                  | -clamps pulmonares ..... 110                            | para várices ..... 58                                    |
| para aplicar micro-clamps                            | -clamps vasculares ..... 110, 111                       | <b>Stille</b> , costótomos..... 96                       |
| vasculares..... 37 – 39                              | -clamps vasculares,                                     | pinzas-gubias..... 72                                    |
| para coger émbolos ..... 63                          | atrauma.... 130 – 132, 138, 140, 148 – 151              | <b>Stille-Liston</b> , pinzas cortantes para huesos 74   |
| para coger tejidos y órganos ..... 92, 93            | -clamps vasculares con bocas                            | <b>Stille-Luer</b> , pinzas-gubias..... 71               |
| para huesos ..... 70                                 | intercambiables..... 158                                | <b>Stille-Ruskin</b> , pinzas-gubias..... 71             |
| para poner clips ..... 115                           | -clamps vasculares de titanio ..... 130, 131            | <b>Struck</b> , separadores costales ..... 100           |
| para poner micro-clips ..... 35, 36                  | -clamps vasculares, micro, atrauma ..... 142            | <b>Strully</b> , tijeras vasculares..... 21              |
| para preparaciones y                                 | -clamps vasculares pediátricos y para                   | Subclavia, pinzas-clamps para ..... 131                  |
| ligaduras ..... 26, 27, 29 – 35, 110, 120            | recién nacidos..... 141                                 | <b>Subramanian-Miniature</b> , atrauma                   |
| para preparaciones y para arterias                   | -clamps vasculares periféricos,                         | pinzas-clamps para aorta ..... 139                       |
| coronarias..... 33                                   | atrauma..... 139  | atrauma  |
| para tumores..... 44                                 | -gubias..... 71, 72                                     | pinzas-clamps para aorta de titanio..... 139             |
| -clamps atraumaticos de titanio .. 119 – 122,        | Porta-agujas ..... 80 – 90                              | Tangencial, pinzas-clamps para                           |
| ..... 126, 128 – 131, 141, 142, 146, 147, 151        | <b>Potts</b> , atrauma pinzas para coarctación..... 119 | oclusión..... 129, 151                                   |
| -clamps auriculares ..... 125                        | atrauma pinzas-clamps..... 119                          | Tejidos, pinzas de disección para coger ..... 45         |
| -clamps auriculares, atrauma ..... 125               | pinzas-clamps para coarctación ..... 119                | Tijeras ..... 2 – 21                                     |
| -clamps bronquiales..... 110, 126                    | <b>Potts-De Martel</b> , tijeras vasculares..... 21     | coronarias..... 10                                       |
| -clamps bronquiales, atrauma ..... 126               | <b>Potts-Smith</b> , pinzas de disección sin            | estandar ..... 2, 3                                      |
| -clamps bronquiales de titanio,                      | dientes ..... 45  | de esternón..... 96                                      |
| atrauma..... 126                                     | <b>Potts-Smith</b> , tijeras-vasculares..... 10, 12, 13 | finas ..... 9  |
| -clamps cardiovasculares, atrauma ..... 141          | tijeras vasculares, Supercut..... 11                    | finas, Supercut..... 9                                   |
| -clamps cardiovasculares de titanio,                 | tijeras vasculares, TC..... 12                          | micro..... 17 – 20                                       |
| atrauma..... 141                                     | <b>Price-Thomas</b> , pinzas-clamps                     | micro-, TC..... 4  |
| -clamps de titanio, atrauma..... 129                 | bronquiales ..... 110                                   | micro- de titanio ..... 19, 20                           |
| -clamps hemostáticas, atrauma ..... 137              | Profundales, pinzas-clamps ..... 139                    | para cirugía ..... 2, 3, 8                               |
| -clamps para anastomosis de                          | Pulmones, pinzas de disección para coger . 46           | para cirugía, TC ..... 2, 3                              |
| aorta ..... 130, 135                                 | Punzonadoras aorticas..... 62                           | para endarterectomia, Supercut ..... 11                  |
| -clamps para anastomosis,                            | Recién nacidos, instrumental para .... 143, 156         | para ligaduras, TC ..... 4                               |
| atrauma..... 120, 129, 134, 135, 139, 149            | pinzas-clamps para..... 157                             | para preparaciones..... 5 – 8                            |
| -clamps para   | <b>Reynolds</b> , tijeras ..... 9                       | para preparaciones, Supercut, TC..... 5                  |
| anastomosis..... 120, 129, 134, 139, 149             | tijeras, Supercut ..... 9                               | para preparaciones, TC ..... 5, 8                        |
| -clamps para anastomosis de aorta,                   | <b>Rienhoff-Finocchietto</b> , separadores              | para venotomia ..... 18                                  |
| atrauma..... 130                                     | costales..... 102                                       | Supercut ..... 11  |
| -clamps para anastomosis de titanio,                 | <b>Rochester-Pean</b> , pinzas hemostáticas ..... 24    | vasculares..... 10, 12 – 16, 21                          |
| atrauma..... 139                                     | <b>Ross</b> , separadores..... 54                       | Tijeras vasculares de titanio ..... 15, 16               |
| -clamps para anastomosis de aorta                    | <b>Rudolf</b> , porta-agujas ..... 86                   | vasculares, TC ..... 12 – 14                             |
| de titanio, atrauma ..... 130                        | <b>Rumel</b> , pinzas para preparaciones y              | Tijeras titanio ..... 15, 16, 19, 20                     |
| Pinzas-clamps para aneurisma de                      | ligaduras ..... 29                                      | Titanio, clamps Bulldog atraumaticos ..... 118           |
| aorta ..... 122, 123, 136                            | <b>Rumel-Belmont</b> , torniquetes ..... 66             | pinzas de disección ..... 43, 44, 46                     |
| -clamps para aneurisma de                            | <b>Ruskin-Liston</b> , pinzas cortantes para            | Titanio, pinzas-clamps ..... 119 – 121, 126,             |
| aorta, atrauma ..... 122, 123, 136                   | huesos ..... 74   | atraumaticos ..... 128 – 131, 139, 141, 142,             |

## Indice

|   |                |
|---|----------------|
| .....   | 146, 147, 151  |
| pinzas .....  | 25, 26, 28     |
| porta-agujas.....   | 83 – 86, 89    |
| separadores de esternón para recién nacidos .....               | 108            |
| tijeras .....   | 15, 16, 19, 20 |
| <b>Toennis</b> , espátulas vasculares.....                      | 60             |
| Torniquetes.....  | 66             |
| <b>Tubbs</b> , dilatadores de aorta .....                       | 62             |
| Tubos de aspiración.....  | 66             |
| Tumores, pinzas para .....                                      | 44             |
| <b>Tönnis</b> , porta-agujas.....                               | 88             |
| <b>Tönnis-Adson</b> , tijeras vasculares, TC .....              | 13             |
| <b>Universal</b> , cizallas para cortar alambre .....           | 76             |
| Usos varios, pinzas clamps para.....                            | 133, 138, 147  |
| <b>Varady</b> , disectores para venas.....                      | 59             |
| extractores para venas .....                                    | 59             |
| instrumental para várices .....                                 | 59             |
| micro-espátulas .....   | 59             |
| micro-extractores para venas .....                              | 59             |
| mini-extractores para venas.....                                | 59             |
| Venotomía, tijeras para .....                                   | 18             |
| <b>Volkman</b> , separadores.....                               | 50             |
| <b>Wangensteen</b> , pinzas de disección sin dientes .....      | 45             |
| <b>Wangensteen</b> , porta-agujas .....                         | 87             |
| <b>Weber</b> , atrauma pinzas-clamps para aorta .....           | 128            |
| <b>Weitlaner</b> , separadores.....                             | 55, 56         |
| <b>Wertheim</b> , atrauma pinzas-clamps para anastomosis .....  | 134            |
| <b>Wickstroem</b> , pinzas para preparaciones y ligaduras ..... | 34             |
| <b>Williams</b> , pinzas para coger tejidos y órganos.....      | 93             |
| <b>Wylie</b> , atrauma pinzas-clamps vasculares.....            | 123            |
| <b>Yankauer</b> , cánulas de aspiración .....                   | 65             |
| <b>Zenker</b> , separadores.....                                | 53             |
| <b>Zweifel</b> , porta-agujas .....                             | 88             |

## Table des matières



|  |                 |  |                         |   |                         |
|--|-----------------|--|-------------------------|---|-------------------------|
| <b>Acland Mod.</b> , clamps micro-vasculaires.....   | 37              | Ciseaux.....                                       | 2 – 21                  | pincés-clamps à usage multiple.....               | 133                     |
| <b>Adson</b> , écarteurs.....                        | 55              | Clamps à disséquer pour les artères                |                         | pincés-clamps atraumatiques pour                  |                         |
| pincés à disséquer Micro-Grip.....                   | 42              | coronaires.....                                    | 33                      | l'anévrisme.....                                  | 122                     |
| pincés à disséquer atraumatiques.....                | 113             | atraumatiques bulldog, titane.....                 | 118                     | pincés-clamps atraumatiques pour                  |                         |
| pincés à disséquer, titane.....                      | 43              | atraumatiques bulldog . 115 – 118, 145, 153        |                         | l'anévrisme de l'aorte.....                       | 122, 123                |
| pincés à disséquer.....                              | 43              | bulldog.....                                       | 35, 115 – 118, 145, 153 | pincés-clamps atraumatiques pour                  |                         |
| pincés à griffes, titane.....                        | 46              | micro-vasculaires atraumatiques.....               | 142                     | l'anévrisme de l'aorte, titane.....               | 122                     |
| pincés à griffes.....                                | 46              | <b>Cleveland</b> , pincés coupantes à os.....      | 73                      | pincés-clamps                                     |                         |
| pincés hémostatiques.....                            | 26              | <b>Coolin</b> , costotomes.....                    | 96                      | atraumatiques.....                                | 121, 130, 131, 138, 140 |
| <b>Adson-Brown</b> , pincés à griffes.....           | 46              | <b>Cone</b> , écarteurs.....                       | 55                      | pincés-clamps atraumatiques à                     |                         |
| pincés à griffes, titane.....                        | 46              | <b>Converse</b> , porte-aiguilles.....             | 85                      | ligature.....                                     | 127                     |
| <b>Alexander</b> , rugines.....                      | 68              | <b>Cooley</b> , boîtes à instruments pour des      |                         | pincés-clamps atraumatiques à                     |                         |
| <b>Allis-Atrauma</b> , pincés à tissu et à           |                 | nouveaux-nés.....                                  | 156                     | préparation et à ligature.....                    | 120                     |
| saisir les organes.....                              | 92              | canules d'aspiration.....                          | 66                      | pincés-clamps pour l'aorte.....                   | 127                     |
| <b>Allison</b> , spatules pulmonaires.....           | 56              | clamps atraumatiques bulldog.....                  | 145, 153                | porte-aiguilles Micro-Grip.....                   | 81                      |
| <b>Alm</b> , écarteurs.....                          | 55              | dilatateurs aortiques.....                         | 62                      | porte-aiguilles, titane.....                      | 84                      |
| Approximateurs.....                                  | 37, 39          | écarteurs costaux.....                             | 102, 105                | porte-aiguilles.....                              | 84, 85                  |
| <b>Babcock</b> , pincés à tissu et à saisir          |                 | écarteurs pour auricles cardiaques.....            | 54                      | <b>De Bakey-Bahson</b> , pincés-clamps atrau-     |                         |
| les organes.....                                     | 92              | écarteurs.....                                     | 54                      | matiques pour l'anévrisme de l'aorte.....         | 136                     |
| <b>Babcock-Atrauma</b> , pincés à tissu et           |                 | pincés à disséquer atraumatiques.....              | 113                     | <b>De Bakey-Bainbridge</b> , pincés-clamps        |                         |
| à saisir les organes.....                            | 92              | pincés-clamps atraumatiques pour                   |                         | atraumatiques.....                                | 121                     |
| <b>Baby-Adson</b> , pincés hémostatiques.....        | 26              | l'anastomose.....                                  | 149                     | <b>De Bakey-Beck</b> , pincés-clamps              |                         |
| <b>Baby-Crile-Wood</b> , porte-aiguilles.....        | 85              | pincés-clamps atraumatiques pour                   |                         | atraumatiques.....                                | 131                     |
| <b>Baby-Hegemann</b> , ciseaux vasculaires.....      | 14              | la coarctation.....                                | 146                     | <b>De Bakey-Castaneda</b> , pincés-clamps         |                         |
| <b>Baby-Mixter</b> , pincés à préparation et à       |                 | pincés-clamps atraumatiques pour                   |                         | atraumatiques cardiovasculaires, titane.....      | 141                     |
| ligature.....  | 32              | la coarctation, titane.....                        | 146                     | <b>De Bakey-Diethrich</b> , clamps atraumatiques  |                         |
| <b>Baby-Satinsky</b> , pincés vasculaires.....       | 111             | pincés-clamps                                      |                         | bulldog.....                                      | 115                     |
| <b>Bailey</b> , rapprocheurs costaux.....            | 108             | atraumatiques.....                                 | 138, 148 – 150          | pincés à disséquer atraumatiques.....             | 113                     |
| <b>Bailey-Baby</b> , rapprocheurs costaux.....       | 108             | pincés-clamps atraumatiques                        |                         | <b>De Bakey-Gerald</b> , pincés à disséquer       |                         |
| <b>Bailey-Gibbon</b> , rapprocheurs costaux.....     | 108             | néonatales.....                                    | 152                     | atraumatiques.....                                | 113                     |
| <b>Barraquer</b> , porte-aiguilles.....              | 90              | pincés-clamps atraumatiques                        |                         | <b>De Bakey-Pean</b> , pincés atraumatiques       |                         |
| <b>Beck</b> , pincés-clamps atraumatiques, titane    | 130             | à ligature, titane.....                            | 151                     | hémostatiques.....                                | 137                     |
| pincés-clamps atraumatiques.....                     | 130, 150        | pincés-clamps atraumatiques                        |                         | <b>De Bakey-Rankin</b> , pincés-clamps            |                         |
| <b>Bengolea</b> , pincés hémostatiques.....          | 27              | à usage multiple.....                              | 147                     | atraumatiques à usage multiple.....               | 138                     |
| <b>Bethune</b> , costotomes.....                     | 97              | pincés-clamps atraumatiques                        |                         | <b>De Bakey-Satinsky</b> , clamps atraumatiques   |                         |
| <b>Biemer</b> , micro-serre-fines.....               | 39              | à usage multiple, titane.....                      | 147                     | bulldog.....                                      | 116                     |
| <b>Biemer-Müller</b> , micro-approximateurs.....     | 39              | pincés-clamps atraumatiques pour                   |                         | <b>De Bakey-Semb</b> , pincés-clamps              |                         |
| <b>Blake</b> , pincés à saisir le caillot.....       | 63              | l'occlusion tangentielle.....                      | 151                     | atraumatiques à ligature.....                     | 128                     |
| Blocage de sécurité.....                             | 119             | pincés-clamps pour la carotide.....                | 144                     | <b>Deaver</b> , écarteurs.....                    | 52, 53                  |
| Boîtes à instruments pour des                        |                 | <b>Cooley-Derra</b> , pincés-clamps                |                         | spatules pulmonaires.....                         | 52                      |
| nouveaux-nés.....                                    | 143, 156        | atraumatiques.....                                 | 151                     | <b>Derra-De Bakey</b> , pincés-clamps atrau-      |                         |
| à stérilisation.....                                 | 64              | <b>Coryllos</b> , écarteurs.....                   | 52                      | matiques pour l'anastomose, titane.....           | 139                     |
| pour clamps bulldog.....                             | 160             | Costotomes.....                                    | 96, 97                  | <b>Desmarres</b> , crochets.....                  | 49                      |
| <b>Borowski</b> , crochets aortiques.....            | 54              | <b>Crafoord</b> , pincés hémostatiques.....        | 28                      | Désoblitérateurs de veines.....                   | 58                      |
| <b>Bozemann</b> , porte-aiguilles.....               | 83              | pincés hémostatiques, titane.....                  | 28                      | <b>Dick</b> , pincés-clamps atraumatiques         |                         |
| <b>Bridge</b> , pincés hémostatiques.....            | 28              | <b>Crafoord-Sellors</b> , pincés pour l'aorte..... | 28                      | pour l'anastomose.....                            | 134                     |
| <b>Brunner</b> , ciseaux à sternum.....              | 97              | <b>Craford</b> , écarteurs.....                    | 51                      | <b>Diethrich</b> , clamps bulldog.....            | 35                      |
| <b>Burford</b> , écarteurs costaux.....              | 107             | <b>Crile</b> , crochets pour les vaisseaux.....    | 61                      | pincés hémostatiques.....                         | 27                      |
| <b>Böhler</b> , pincés coupantes à os.....           | 73              | <b>Crile-Wood</b> , porte-aiguilles.....           | 85                      | pincés-clamps atraumatiques pour                  |                         |
| Canules d'aspiration pour des vaisseaux              | 59              | Crochets à veines.....                             | 61                      | l'aorte.....                                      | 124                     |
| d'aspiration.....                                    | 65              | aortiques.....                                     | 54                      | porte-aiguilles.....                              | 90                      |
| Canules d'irrigation.....                            | 59              | Crochets.....                                      | 48, 49                  | Dilatateurs aortiques.....                        | 62                      |
| <b>Castaneda</b> , écarteurs costaux.....            | 106             | Crochets Phlebectomie.....                         | 60                      | vasculaires.....                                  | 63, 64                  |
| pincés-clamps néonatales.....                        | 157             | <b>Cushing</b> , crochets.....                     | 48, 61                  | <b>Doyen</b> , rugines.....                       | 69                      |
| <b>Castroviejo</b> , porte-aiguilles Micro-Grip..... | 80              | pincés à disséquer.....                            | 45                      | <b>Duval</b> , pincés à tissu et à saisir les     |                         |
| porte-aiguilles, titane.....                         | 89              | <b>Cushing-Kocher</b> , crochets.....              | 49                      | organes.....                                      | 93                      |
| porte-aiguilles.....                                 | 89, 90          | <b>Dale</b> , pincés-clamps atraumatiques          |                         | à sternum pour des nouveaux-nés,                  |                         |
| Ciseaux à dissection, Supercut, TC.....              | 5               | périphériques.....                                 | 139                     | titane.....                                       | 108                     |
| à dissection, TC.....                                | 2, 3, 5 – 8     | pincés-gouges.....                                 | 72                      | costaux.....                                      | 100 – 108               |
| à dissection.....                                    | 2, 3, 5 – 8     | <b>Dardik</b> , pincés-clamps atraumatiques.....   | 132                     | pour auricules cardiaques.....                    | 54                      |
| à endartérectomie, Supercut.....                     | 11              | écarteurs.....                                     | 54                      | thoraciques.....                                  | 104                     |
| à fils.....  | 76              | <b>Davidson-Alexander</b> , rugines.....           | 68                      | Ecarteurs.....                                    | 48 – 56                 |
| à ligature, TC.....                                  | 4               | Daviers porte-os.....                              | 70                      | <b>Echlin</b> , pince-gouges.....                 | 72                      |
| à sternum.....                                       | 96              | <b>Davis</b> , spatules pour les vaisseaux.....    | 60                      | Emporte-pièces aortiques.....                     | 62                      |
| à veines.....  | 18              | <b>De Bakey</b> , boîtes à instruments pour des    |                         | <b>Eufrate-Pasque</b> , porte-aiguilles.....      | 87                      |
| chirurgicaux, TC.....                                | 2, 3            | nouveaux-nés.....                                  | 143                     | <b>Ferguson</b> , canules d'aspiration.....       | 65                      |
| chirurgicaux.....                                    | 2, 3, 8         | canules d'aspiration.....                          | 65                      | daviers porte-os.....                             | 70                      |
| coronaires.....                                      | 10              | ciseaux vasculaires, TC.....                       | 14                      | Fils à os.....                                    | 76                      |
| fins, Supercut.....                                  | 9               | ciseaux vasculaires.....                           | 10, 14                  | <b>Finocchietto</b> , écarteurs                   |                         |
| fins.....  | 9               | clamps atraumatiques bulldog.....                  | 116, 117                | costaux.....                                      | 101, 105, 107           |
| vasculaires, TC.....                                 | 12 – 14         | dilatateurs vasculaires.....                       | 63                      | <b>Finocchietto</b> , porte-aiguilles.....        | 88                      |
| vasculaires, titane.....                             | 15, 16          | écarteurs costaux.....                             | 103                     | <b>Finocchietto-Baby</b> , écarteurs costaux..... | 100                     |
| vasculaires.....                                     | 10, 12 – 16, 21 | pincés à disséquer atraumatiques,                  |                         | <b>Finocchietto-Baby-Haight</b> , écarteurs       |                         |
| Supercut.....  | 11              | titane.....  | 113, 114                | costaux.....                                      | 107                     |
| titane.....  | 15, 16, 19, 20  | pincés à disséquer atraumatiques.....              | 113, 114                |   |                         |

## Table des matières

|   |          |  |         |  |                           |
|---|----------|--|---------|--|---------------------------|
| <b>Finocchietto-Burford</b> , écarteurs costaux .....             | 101      | <b>Lambert-Kay</b> , pinces-clamps atraumatiques pour l'anastomose de l'aorte, titane..... | 130     | <b>Mixer O'Shaugnessy</b> , pinces à préparation et à ligature .....                   | 33                        |
| <b>Finocchietto-Mini</b> , écarteurs costaux .....                | 100      | pinces-clamps atraumatiques pour l'anastomose de l'aorte.....                              | 130     | <b>Mixer</b> , pinces à préparation et à ligature .....                                | 33                        |
| <b>Frazier</b> , canules d'aspiration .....                       | 65       | <b>Lambotte</b> , rugines.....   | 68      | <b>Morris-De Bakey</b> , pinces-clamps atraumatiques pour l'anastomose de l'aorte..... | 135                       |
| <b>Freer</b> , spatules à vaisseaux .....                         | 60       | <b>Langenbeck</b> , daviers porte-os.....  | 70      | <b>Morse</b> , écarteurs costaux .....   | 106                       |
| <b>Frykholm</b> , pinces-gouges .....                             | 72       | écarteurs.....   | 50      | <b>Morse-Favoloro</b> , écarteurs costaux ..   | 104, 106                  |
| <b>Garrett</b> , dilataleurs vasculaires .....                    | 64       | rugines.....   | 68      | <b>Mosquito</b> , pinces atraumatiques hémostatiques .....                             | 137                       |
| <b>Gemini</b> , pinces à préparation et à ligature ..             | 32       | <b>Langenbeck-Ryder</b> , porte-aiguilles.....   | 88      | <b>Myers</b> , désoblitérateurs de veines .....  | 58                        |
| <b>Gerald</b> , pinces à disséquer, titane.....                   | 43       | <b>Lawrence</b> , pinces à préparation et à ligature .....                                 | 34      | <b>Müller</b> , approximateurs .....   | 39                        |
| pinces à disséquer.....   | 43       | <b>Lazar</b> , micro-pinces à disséquer .....  | 45      | serre-fines.....   | 38                        |
| pinces à griffes, titane.....                                     | 46       | <b>Lebsche</b> , ciseau-burins à sternum.....  | 97      | <b>Nabatoff</b> , trousse à veines .....   | 58                        |
| pinces à griffes.....   | 46       | <b>Lees</b> , pinces-clamps atraumatiques à bronches.....                                  | 126     | <b>Nelson</b> , pinces à saisir.....   | 46                        |
| <b>Giertz-Stille</b> , costotomes .....                           | 96       | pinces-clamps atraumatiques à bronches, titane .....                                       | 126     | <b>Ochsner</b> , pinces-clamps atraumatiques pour l'aorte.....                         | 124                       |
| <b>Gil-Vernet</b> , crochets .....                                | 48       | <b>Leksell</b> , pinces-gouges .....   | 72      | <b>Ochsner-Kocher</b> , pinces hémostatiques....                                       | 24                        |
| <b>Gillies</b> , pince à griffes, titane.....                     | 46       | <b>Leland-Jones</b> , pinces-clamps atraumatiques .....                                    | 121     | <b>Overholt</b> , pinces à préparation et à ligature .....                             | 30                        |
| pinces à griffes.....   | 46       | <b>Leimon</b> , porte-aiguilles .....  | 87      | <b>Overholt-Geissendörfer</b> , pinces à préparation et à ligature.....                | 31                        |
| <b>Glover</b> , clamps atraumatiques bulldog..                    | 116, 145 | <b>Leriche</b> , pinces hémostatiques .....  | 25      | <b>Overholt-Mixer</b> , pinces à préparation et à ligature .....                       | 31                        |
| pinces-clamps atraumatiques pour l'anastomose.....                | 129, 135 | pinces hémostatiques, titane .....   | 25      | <b>Overholt-Slim</b> , pinces à préparation et à ligature .....                        | 30                        |
| pinces-clamps pour l'anastomose .....                             | 120      | <b>Lexer</b> , ciseaux, Supercut, TC.....  | 5       | <b>Pean</b> , pinces hémostatiques .....   | 24                        |
| <b>Gluck</b> , costotomes .....                                   | 96       | ciseaux, TC.....   | 5       | <b>Phlébo-dissecteurs</b> .....  | 59                        |
| <b>Gregory</b> , pinces-clamps atraumatiques profondales.....     | 139      | <b>Lichtenberg</b> , porte-aiguilles.....  | 88      | <b>Phlébo-extracteurs</b> .....  | 59                        |
| <b>Gregory-Soft</b> , clamps atraumatiques bulldog .....          | 117      | <b>Liston</b> , pinces coupantes à os .....  | 73      | <b>Pinces à disséquer Micro-Grip</b> .....   | 42                        |
| <b>Haight</b> , écarteurs costaux.....                            | 102      | <b>Liston-Key</b> , pinces coupantes à os .....  | 74      | à disséquer annulaires Micro-Grip.....   | 42                        |
| <b>Halle</b> , spatules à vaisseaux.....                          | 61       | <b>Little</b> , crochets .....   | 48      | à disséquer annulaires .....   | 42                        |
| <b>Halsey</b> , porte-aiguilles, titane.....                      | 85       | <b>Love (Morse)</b> , crochets.....  | 48      | à disséquer atraumatiques, titane.....   | 113                       |
| porte-aiguilles .....   | 85       | <b>Lovelace</b> , pinces-clamps à poumons .....  | 110     | à disséquer atraumatiques .....  | 113, 114                  |
| <b>Halsted-Mosquito</b> , pinces hémostatiques..                  | 25       | <b>Markwalder</b> , pinces coupantes à os .....  | 73      | à disséquer pour tumeurs .....   | 44                        |
| pinces hémostatiques, titane .....                                | 25       | <b>Martin</b> , écarteurs.....   | 51      | à disséquer, Micro-Grip .....  | 42                        |
| <b>Harken</b> , pinces vasculaires .....                          | 111      | <b>Masson</b> , porte-aiguilles.....   | 87      | à disséquer, titane.....   | 43, 44, 46                |
| pinces-clamps atraumatiques auriculaires .....                    | 125      | <b>Mathieu-Kocher</b> , porte-aiguilles .....  | 88      | à disséquer .....  | 42 - 46                   |
| <b>Harrington</b> , écarteurs .....                               | 53       | <b>Matson</b> , rugines .....  | 68      | à fils .....   | 76 - 78                   |
| pinces à préparation et à ligature .....                          | 29       | <b>Mayo</b> , ciseaux à ligature.....  | 4       | à griffes .....  | 46                        |
| <b>Harrington-Baby</b> , écarteurs .....                          | 53       | ciseaux, TC.....   | 5       | à poser les clips .....  | 37 - 39, 115              |
| <b>Harrington-Pemberton</b> , écarteurs .....                     | 53       | ciseaux.....   | 5       | à préparation et à ligature .....  | 26, 27, 29 - 36, 110, 120 |
| <b>Hartmann</b> , pinces hémostatiques .....                      | 26       | pinces à saisir les poumons.....   | 46      | à saisir le caillot .....  | 63                        |
| pinces hémostatiques, titane .....                                | 26       | <b>Mayo-Hegar</b> , porte-aiguilles, titane .....  | 83, 84  | à saisir les poumons .....   | 46                        |
| <b>Harvey</b> , ciseaux à fils .....                              | 76       | porte-aiguilles .....  | 83      | à saisir les tumeurs.....  | 44                        |
| <b>Hegar-Vascular</b> , porte-aiguilles .....                     | 86       | <b>Mc Indoe</b> , pinces à disséquer Micro-Grip .....                                      | 42      | à saisir .....   | 45                        |
| <b>Hegemann</b> , ciseaux vasculaires .....                       | 14       | pinces à disséquer.....  | 43      | à tissu et à saisir les organes .....  | 92, 93                    |
| <b>Heiss</b> , pinces à préparation et à ligature....             | 31       | pinces coupantes à os .....  | 73      | atraumatiques à préparation et à ligature .....  | 120                       |
| <b>Henly</b> , pinces-clamps atraumatiques subclaviculaires ..... | 131      | <b>Mercedes</b> , écarteurs thoraciques .....  | 104     | atraumatiques hémostatiques.....   | 137                       |
| <b>Hepp-Scheidel</b> , porte-aiguilles .....                      | 90       | <b>Metzenbaum</b> , ciseaux à dissection, TC..   | 6 - 8   | atraumatiques subclaviculaires.....  | 131                       |
| <b>Instruments à os</b> .....                                     | 68 - 78  | ciseaux à dissection, TC, Supercut.....  | 8       | atraumatiques vasculaires, titane .....  | 130                       |
| pour les varices.....   | 59       | ciseaux à dissection.....  | 6 - 8   | atraumatiques vasculaires .....  | 131, 132, 138,            |
| vasculaires .....   | 58 - 66  | ciseaux à ligature .....   | 4       | .....  | 140, 148 - 151            |
| <b>Ima</b> , Pinces à disséquer Micro-Grip .....                  | 42       | <b>Metzenbaum-Fino</b> , ciseaux à dissection..  | 6, 7    | coupantes à os .....   | 73, 74                    |
| <b>Jacobsen</b> , ciseaux vasculaires, titane .....               | 16       | ciseaux à dissection, TC .....   | 6, 7    | coupantes latérales et frontales.....  | 78                        |
| ciseaux vasculaires.....  | 16       | <b>Micro-Mosquito</b> , pinces hémostatiques .....   | 26      | hémostatiques .....  | 24 - 28                   |
| <b>Jacobson</b> , porte-aiguilles Micro-Grip .....                | 80       | pinces hémostatiques, titane .....   | 26      | néonatales .....   | 157                       |
| porte-aiguilles .....   | 90       | <b>Micro-Ryder</b> , porte-aiguilles, titane .....   | 86      | pédiatriques .....   | 141, 143, 152, 154 - 157  |
| <b>Jacobson-Adson</b> , pinces hémostatiques....                  | 27       | porte-aiguilles .....  | 86      | pour poser les serre-fines .....   | 35, 36                    |
| <b>Jacobson-Halsted</b> , pinces hémostatiques..                  | 25       | Micro-ciseaux, titane.....   | 19, 20  | subclaviculaires .....   | 131                       |
| <b>Jameson-Werber</b> , ciseaux .....                             | 9        | Micro-ciseaux .....  | 17 - 20 | vasculaires avec des mors interchangeable .....  | 158                       |
| <b>Javid</b> , pinces-clamps pour la carotide.....                | 144      | Micro-ciseaux .....  | 17 - 20 | vasculaires .....  | 110, 111                  |
| <b>Jorgensen</b> , ciseaux vasculaires .....                      | 13       | Micro-phlébo-extracteurs.....  | 59      | <b>Pinces-clamps à bronches</b> .....  | 110, 126                  |
| <b>Joseph</b> , ciseaux .....                                     | 9        | Micro-pinces à disséquer.....  | 43, 44  | <b>Pinces-clamps à poumons</b> .....   | 110                       |
| <b>Kader</b> , écarteurs .....                                    | 53       | à suture.....  | 45      | à usage multiple .....   | 133, 138, 147             |
| <b>Kalt</b> , porte-aiguilles .....                               | 89       | Micro-porte-aiguilles .....  | 82, 83  | atraumatiques pour l'anastomose.....   | 120,                      |
| <b>Kantrowitz</b> , pinces à préparation et à ligature .....      | 29       | Micro-serre-fines pour prématurés .....  | 142     | .....  | 129, 134, 135, 139, 149   |
| <b>Kelly</b> , ciseaux .....                                      | 8        | Micro-serre-fines .....  | 37 - 39 | atraumatiques pour l'anastomose de l'aorte.....  | 130, 135                  |
| écarteurs.....  | 51       | Micro-spatules .....   | 59      | atraumatiques pour l'anastomose de l'aorte, titane .....                               | 130                       |
| <b>Klingenberg-Loth</b> , ciseaux vasculaires, TC                 | 13       | <b>Microvascular</b> , porte-aiguilles Micro-Grip ..                                       | 81      |  |                           |
| ciseaux, vasculaires.....   | 13       | porte-aiguilles .....  | 86      |  |                           |
| <b>Kocher</b> , écarteurs .....                                   | 50       | <b>Mikulicz</b> , écarteurs .....  | 51      |  |                           |
| <b>Kocher</b> , pinces hémostatiques.....                         | 24       | <b>Millesi</b> , micro-ciseaux .....   | 18      |  |                           |
| <b>Kocher-Langenbeck</b> , écarteurs .....                        | 50       | <b>Mills</b> , ciseaux vasculaires .....   | 21      |  |                           |
| <b>Krayenbühl</b> , crochets .....                                | 61       | <b>Mini-Gemini</b> , pinces à préparation et à ligature .....                              | 32      |  |                           |
| <b>König</b> , crochets.....                                      | 49       | Mini-phlébo-extracteurs .....  | 59      |  |                           |
| <b>Lahay (Sweet)</b> , pinces à préparation et à ligature .....   | 34       |  |         |  |                           |



## Table des matières



|   |                                    |
|---|------------------------------------|
| atraumatiques pour l'anévrisme                        |                                    |
| de l'aorte.....                                       | 122, 123, 136                      |
| atraumatiques pour                                    |                                    |
| l'aorte.....  | 124, 127, 128, 139                 |
| atraumatiques auriculaires.....                       | 125                                |
| atraumatiques bronchiques, titane.....                | 126                                |
| atraumatiques bronchiques.....                        | 126                                |
| atraumatiques pour la coarctation,                    |                                    |
| titane.....   | 146                                |
| atraumatiques cardiovasculaires.....                  | 141                                |
| atraumatiques cardiovasculaires,                      |                                    |
| titane.....   | 141                                |
| atraumatiques pour la                                 |                                    |
| pédiatrie.....  | 141 – 143, 152, 154 – 157          |
| atraumatiques pour la ligature, titane....            | 151                                |
| atraumatiques pour la                                 |                                    |
| ligature.....   | 127, 128, 138, 151                 |
| atraumatiques à usage multiple,                       |                                    |
| titane.....   | 147                                |
| atraumatiques à usage                                 |                                    |
| multiple.....   | 133, 138, 147                      |
| atraumatiques néonatales et                           |                                    |
| pédiatriques.....                                     | 154, 155                           |
| atraumatiques périphériques.....                      | 139                                |
| atraumatiques profondales, titane.....                | 139                                |
| atraumatiques profondales.....                        | 139                                |
| atraumatiques pour l'occlusion                        |                                    |
| tangentielle.....                                     | 129, 151                           |
| atraumatiques pour la ligature, titane....            | 128                                |
| atraumatiques pour l'occlusion                        |                                    |
| tangentielle, titane.....                             | 129                                |
| atraumatiques, titane.....                            | 119 – 122, 126,                    |
| .....   | 128 – 131, 139, 142, 146, 147, 151 |
| atraumatiques.....                                    | 119 – 157                          |
| auriculaires.....                                     | 125                                |
| cardiovasculaires pour des enfants                    |                                    |
| et des nouveaux nés.....                              | 141                                |
| pour l'anastomose.....                                | 120, 129, 134, 139, 149            |
| pour l'anastomose de l'aorte.....                     | 130, 135                           |
| pour l'anévrisme de l'aorte....                       | 122, 123, 136                      |
| pour l'aorte.....                                     | 28, 124, 127, 128, 139             |
| pour l'occlusion tangentielle.....                    | 129, 151                           |
| pour la carotide.....                                 | 144                                |
| pour la coarctation.....                              | 119, 136, 146                      |
| profondales.....                                      | 139                                |
| vasculaires périphériques.....                        | 139                                |
| Pincés-gouges.....                                    | 71, 72                             |
| Porte-aiguilles Micro-Grip.....                       | 80, 81                             |
| titane.....   | 83 – 86, 89                        |
| Porte-aiguilles.....                                  | 80 – 90                            |
| <b>Potts</b> , pincés-clamps atraumatiques            |                                    |
| pour la coarctation.....                              | 119                                |
| pincés-clamps atraumatiques.....                      | 119                                |
| pincés-clamps pour la coarctation.....                | 119                                |
| <b>Potts-De Martel</b> , ciseaux vasculaires.....     | 21                                 |
| <b>Potts-Smith</b> , ciseaux vasculaires, Supercut 11 |                                    |
| ciseaux vasculaires, TC.....                          | 12                                 |
| ciseaux vasculaires.....                              | 10, 12, 13                         |
| pincés à disséquer.....                               | 45                                 |
| <b>Price-Thomas</b> , pincés-clamps à bronches.....   | 110                                |
| Rapprocheurs costaux.....                             | 108                                |
| <b>Reynolds</b> , ciseaux, Supercut.....              | 9                                  |
| ciseaux.....  | 9                                  |
| <b>Rienhoff-Finocchietto</b> , écarteurs costaux..... | 102                                |
| <b>Rochester-Pean</b> , pincés hémostatiques.....     | 24                                 |
| <b>Ross</b> , écarteurs.....                          | 54                                 |
| Ruban silicone.....                                   | 160                                |
| <b>Rudolf</b> , porte-aiguilles.....                  | 86                                 |
| Rugines.....  | 68, 69                             |
| <b>Rumel</b> , pincés à préparation et à ligature.... | 29                                 |
| <b>Rumel-Belmont</b> , tourniquets.....               | 66                                 |
| <b>Ruskin-Liston</b> , pincés coupantes à os.....     | 74                                 |
| <b>Ryder</b> , porte-aiguilles Micro-Grip.....        | 81                                 |
| porte-aiguilles.....                                  | 86                                 |
| <b>Santulli</b> , clamps atraumatiques bulldog....    | 117                                |
| <b>Sarot</b> , pincés hémostatiques.....              | 28                                 |
| porte-aiguilles.....                                  | 87                                 |
| <b>Satinsky</b> , ciseaux vasculaires.....            | 13                                 |
| pincés-clamps vasculaires.....                        | 111                                |
| <b>Satinsky/De Bakey</b> , pincés-clamps atrauma-     |                                    |
| tiques pour l'occlusion tangentielle.....             | 129                                |
| <b>Sauerbruch</b> , costotomes.....                   | 96                                 |
| écarteurs.....  | 52                                 |
| pincés-gouges.....                                    | 72                                 |
| <b>Sawtell</b> , pincés à préparation et à ligature.. | 33                                 |
| <b>Schmid</b> , canules d'irrigation vasculaires....  | 59                                 |
| spatules vasculaires.....                             | 60                                 |
| <b>Schwartz</b> , pincés à poser les serre-fines....  | 35                                 |
| <b>Sellors</b> , rapprocheurs costaux.....            | 108                                |
| <b>Semb</b> , daviers porte-os.....                   | 70                                 |
| pincés à préparation et à ligature.....               | 110                                |
| pincés coupantes à os.....                            | 74                                 |
| pincés-gouges.....                                    | 71                                 |
| rugines.....  | 69                                 |
| Serre-fines.....                                      | 36 – 39                            |
| <b>Simon</b> , écarteurs.....                         | 51                                 |
| <b>Singley-Tuttle</b> , pincés à saisir.....          | 46                                 |
| Sondes pour endartérectomie.....                      | 59                                 |
| Spatules pour les vaisseaux.....                      | 60, 61                             |
| pulmonaires.....                                      | 52 – 54, 56                        |
| <b>Stille</b> , costotomes.....                       | 96                                 |
| pincés-gouges.....                                    | 72                                 |
| <b>Stille-Liston</b> , pincés coupantes à os.....     | 74                                 |
| <b>Stille-Luer</b> , pincés-gouges.....               | 71                                 |
| <b>Stille-Ruskin</b> , pincés-gouges.....             | 71                                 |
| <b>Struck</b> , écarteurs costaux.....                | 100                                |
| <b>Strully</b> , ciseaux vasculaires.....             | 21                                 |
| <b>Subramanian-Miniature</b> , pincés-clamps          |                                    |
| atraumatiques pour l'aorte.....                       | 139                                |
| pincés-clamps atraumatiques pour                      |                                    |
| l'aorte, titane.....                                  | 139                                |
| <b>Toennis</b> , spatules vasculaires.....            | 60                                 |
| Tourniquets.....                                      | 66                                 |
| Trousses à veines.....                                | 58                                 |
| <b>Tubbs</b> , dilateurs aortiques.....               | 62                                 |
| Tubes d'aspiration.....                               | 66                                 |
| <b>Tönnis</b> , porte-aiguilles.....                  | 88                                 |
| <b>Tönnis-Adson</b> , ciseaux vasculaires, TC.....    | 13                                 |
| <b>Universal</b> , ciseaux à fils.....                | 76                                 |
| <b>Varady</b> , instruments pour les varices.....     | 59                                 |
| micro-phlébo-extracteurs.....                         | 59                                 |
| micro-spatules.....                                   | 59                                 |
| mini-phlébo-extracteurs.....                          | 59                                 |
| phlébo-dissécteurs.....                               | 59                                 |
| phlébo-extracteurs.....                               | 59                                 |
| <b>Volkman</b> , écarteurs.....                       | 50                                 |
| <b>Wangensteen</b> , pincés à disséquer.....          | 45                                 |
| porte-aiguilles.....                                  | 87                                 |
| <b>Weber</b> , pincés-clamps atraumatiques            |                                    |
| pour l'aorte.....                                     | 128                                |
| <b>Weitlaner</b> , écarteurs.....                     | 55, 56                             |
| <b>Wertheim</b> , pincés-clamps atraumatiques         |                                    |
| pour l'anastomose.....                                | 134                                |
| <b>Wickstroem</b> , pincés à préparation et à         |                                    |
| ligature.....   | 34                                 |
| <b>Williams</b> , pincés à tissu et a saisir          |                                    |
| les organes.....                                      | 92                                 |
| <b>Wylie</b> , pincés-clamps atraumatiques.....       | 123                                |
| <b>Yankauer</b> , canules d'aspiration.....           | 65                                 |
| <b>Zenker</b> , écarteurs.....                        | 53                                 |
| <b>Zweifel</b> , porte-aiguilles.....                 | 88                                 |

|   |             |  |                      |  |              |
|---|-------------|--|----------------------|--|--------------|
| <b>Acland</b> micro clips vascolare .....           | 37          | set strumenti per neonati .....                    | 156                  | Divaricatori per sterno per neonati, titanio .....       | 108          |
| <b>Adson</b> divaricatori .....                     | 55          | tubi d'aspirazione .....                           | 66                   | <b>Doyen</b> periostomi .....                            | 69           |
| micro-pinze .....                                   | 42          | <b>Cooley-Baby</b> divaricatori costali .....      | 102, 105             | <b>Duval</b> pinze per afferrare tessuti ed organi ..... | 93           |
| pinze anatomiche .....                              | 43          | <b>Cooley-Derra</b> pinze cardiovascolari          |                      | <b>Echlin</b> pinze-sgorbie .....                        | 72           |
| pinze cardiovascolari atraumatiche .....            | 113         | atraumatiche .....                                 | 151                  | Estrattore flebo .....                                   | 59           |
| pinze chirurgiche .....                             | 46          | <b>Cooley-Glover</b> pinze atraumatiche            |                      | <b>Eufrate-Pasque</b> portaghi .....                     | 87           |
| pinze emostatiche .....                             | 26          | Bulldog .....                                      | 145                  | <b>Favaloro</b> forbici .....                            | 10           |
| <b>Adson-Baby (Cone)</b> divaricatori .....         | 55          | <b>Coryllos</b> divaricatori .....                 | 52                   | <b>Fergusson</b> tenaglie per ossa .....                 | 70           |
| <b>Adson-Brown</b> pinze chirurgiche .....          | 46          | Costotomi .....                                    | 95 – 97              | tubi d'aspirazione .....                                 | 65           |
| <b>Alexander</b> periostomi .....                   | 68          | <b>Crafoord</b> pinze per bronchi .....            | 28                   | Filo per ossa .....                                      | 76           |
| <b>Alexander-Davidson</b> periostomi .....          | 68          | <b>Crafoord-Sellors</b> pinze per aorta .....      | 28                   | <b>Finocchietto</b> divaricatori costali .....           | 101          |
| <b>Allis-Atrauma</b> pinze per afferrare tessuti    |             | <b>Crawford</b> divaricatori .....                 | 51                   | divaricatori costali modificato .....                    | 105          |
| ed organi .....                                     | 92          | <b>Crile</b> uncini .....                          | 61                   | divaricatori costali in alluminio .....                  | 107          |
| <b>Allison</b> spatole per polmone .....            | 56          | <b>Crile-Wood</b> portaghi .....                   | 85                   | portaghi .....   | 88           |
| <b>Alm</b> divaricatori .....                       | 55          | <b>Cushing</b> pinze anatomiche .....              | 45                   | <b>Finocchietto-Baby</b> divaricatori costali .....      | 100          |
| Approssimatore costali .....                        | 108         | uncini .....                                       | 48, 61               | <b>Finocchietto-Baby-Haight</b> divaricatori             |              |
| Approssimatore per micro-clips .....                | 37, 39      | <b>Cushing-Kocher</b> divaricatori .....           | 49                   | costali in alluminio .....                               | 107          |
| Astuccio per le vene .....                          | 58          | <b>Dale</b> pinze cardiovascolari atraumatiche ... | 139                  | <b>Finocchietto-Burford</b> divaricatori costali ..      | 101          |
| <b>Babcock (Standard)</b> pinze per afferrare       |             | pinze-sgorbie .....                                | 72                   | <b>Finocchietto-Mini</b> divaricatori costali .....      | 100          |
| tessuti ed organi .....                             | 92          | <b>Dardik</b> pinze cardiovascolari atraumatiche   | 132                  | Flebo-estrattore .....                                   | 59           |
| <b>Babcock-Atrauma</b> pinze per afferrare          |             | <b>Davidson</b> divaricatori auricolare .....      | 54                   | Forbici .....  | 2 – 21       |
| tessuti ed organi .....                             | 92          | <b>Davidson-Alexander</b> periostomi .....         | 68                   | coronari .....   | 10           |
| <b>Baby-Adson</b> pinze emostatiche .....           | 26          | <b>Davis</b> spatole vascolari .....               | 60                   | fine .....   | 9 – 21       |
| <b>Baby-Cooley</b> divaricatori costali .....       | 102         | <b>Deaver (Grip-Handle)</b> divaricatori .....     | 53                   | per chirurgia .....                                      | 2 – 3, 5 – 8 |
| <b>Baby-Crile-Wood</b> portaghi .....               | 85          | <b>Deaver</b> divaricatori .....                   | 52                   | per chirurgia e dissezione .....                         | 2 – 3,       |
| <b>Baby-Finocchietto</b> divaricatori costali ..... | 100         | <b>De Bakey</b> dilatatori vascolari .....         | 63                   | (tungsteno) .....  | 5 – 8        |
| <b>Baby-Haight</b> divaricatori costali .....       | 107         | divaricatori costali .....                         | 103                  | per endarterectomia .....                                | 11           |
| <b>Baby-Harrington</b> divaricatori .....           | 53          | forbici vascolari .....                            | 10, 14               | per fili metallici .....                                 | 76           |
| <b>Baby-Hegemann</b> forbici vascolari .....        | 14          | pinze atraumatiche Bulldog .....                   | 116, 117             | per le vene .....  | 18           |
| <b>Baby-Mixer</b> pinze per dissezione .....        | 32          | pinze cardiovascolari                              |                      | per legature .....                                       | 4            |
| <b>Baby-Satinsky</b> pinze cardiovascolari .....    | 111         | atraumatiche .....                                 | 113 – 117, 119 – 142 | per preparazione .....                                   | 7 – 8, 20    |
| <b>Bahnson-De Bakey</b> pinze per                   |             | pinze per aneurisma dell'aorta .....               | 122 – 123            | per sterno .....   | 96           |
| aneurisma dell'aorta .....                          | 136         | pinze per aorta .....                              | 127                  | Supercut .....   | 11           |
| <b>Bailey</b> approssimatori costali .....          | 108         | pinze per preparazioni e legature ..               | 120, 127             | vascolari .....  | 10 – 16      |
| <b>Bailey-Baby</b> approssimatori costali .....     | 108         | pinze per vari usi .....                           | 133                  | <b>Frazier</b> tubi d'aspirazione .....                  | 65           |
| <b>Bailey-Gibbon</b> divaricatori costali .....     | 108         | portaghi .....                                     | 81, 84, 85           | <b>Freer</b> spatole .....                               | 60           |
| Banco di silicone solo .....                        | 160         | tubi d'aspirazione .....                           | 65                   | <b>Frykholm</b> pinze-sgorbie .....                      | 72           |
| <b>Barraquer</b> portaghi .....                     | 90          | <b>De Bakey-Bahnson</b> pinze per aneurisma        |                      | <b>Garrett</b> dilatatori vascolari .....                | 64           |
| <b>Beck</b> pinze cardiovascolari atraumatiche      |             | dell'aorta .....                                   | 136                  | <b>Gemini</b> pinze per dissezione .....                 | 32           |
| titanio .....                                       | 130, 150    | <b>De Bakey-Bainbridge</b> pinze .....             | 121                  | <b>Gerald</b> pinze anatomiche .....                     | 43           |
| <b>Bengolea</b> pinze per preparazione .....        | 27          | <b>De Bakey-Bayonet</b> pinze cardiovascolari      |                      | pinze chirurgiche .....                                  | 46           |
| <b>Bethune</b> costotomi .....                      | 97          | atraumatiche .....                                 | 113                  | <b>Giertz-Stille</b> forbici per sterno .....            | 96           |
| <b>Biemer</b> micro-serrafini .....                 | 39          | <b>De Bakey-Beck</b> pinze cardiovascolari         |                      | <b>Gil-Vernet</b> divaricatori .....                     | 48           |
| <b>Biemer-Müller</b> micro-approssimatori .....     | 39          | atraumatiche .....                                 | 131                  | <b>Gillies</b> pinze chirurgiche .....                   | 46           |
| <b>Blake</b> pinze per afferrare ad embolia .....   | 63          | <b>De Bakey-Bridge</b> pinze cardiovascolari       |                      | <b>Glover (Potts)</b> pinze per anastomosi .....         | 120          |
| <b>Borowski</b> divaricatori auricolare .....       | 54          | atraumatiche .....                                 | 121                  | <b>Glover</b> pinze atraumatiche Bulldog .....           | 116          |
| <b>Bozemann</b> portaghi .....                      | 83          | <b>De Bakey-Castaneda</b> pinze titanio per        |                      | pinze cardiovascolari atraumatiche .....                 | 135          |
| <b>Bridge</b> pinze emostatiche .....               | 28          | bambini e neonati .....                            | 141                  | pinze per anastomosi .....                               | 129          |
| <b>Brunner</b> forbici per sterno .....             | 97          | <b>De Bakey-Diethrich</b> pinze atraumatiche       |                      | <b>Gluck</b> costotomi .....                             | 96           |
| <b>Burford</b> divaricatori costali in alluminio .. | 107         | Bulldog .....                                      | 115                  | <b>Gregory</b> pinze per profondità .....                | 139          |
| <b>Böhler</b> pinze cesoie per ossa .....           | 73          | pinze per cardiovascolari atraumatiche ..          | 113                  | <b>Gregory-Soft</b> pinze atraumatiche Bulldog           | 117          |
| <b>Castaneda</b> divaricatori costali .....         | 106         | <b>De Bakey-Fine</b> portaghi .....                | 84                   | <b>Haight</b> divaricatori costali .....                 | 102          |
| pinze per neonati .....                             | 157         | <b>De Bakey-Gerald</b> pinze cardiovascolari       |                      | <b>Halle</b> spatole .....                               | 61           |
| <b>Castaneda-De Bakey</b> pinze per bambini         |             | atraumatiche .....                                 | 113                  | <b>Halsey</b> portaghi .....                             | 85           |
| e neonati .....                                     | 141         | <b>De Bakey-Beck</b> pinze atraumatiche .....      | 131                  | <b>Halsted-Mosquito</b> pinze emostatiche .....          | 25           |
| <b>Castroviejo</b> forbici .....                    | 2, 3, 8     | <b>De Bakey-Pean</b> pinze cardiovascolari         |                      | <b>Harken</b> pinze cardiovascolari .....                | 111, 126     |
| pinze .....   | 46          | atraumatiche .....                                 | 137                  | pinze per padiglione auricolare                          |              |
| portaghi .....                                      | 80, 89 – 90 | <b>De Bakey-Rankin</b> pinze per vari usi .....    | 138                  | atraumatiche .....                                       | 125          |
| Chiusura di sicurezza per pinze .....               | 119         | <b>De Bakey-Satinsky</b> pinze atraumatiche        |                      | <b>Harrington</b> divaricatori .....                     | 53           |
| <b>Cleveland</b> pinze cesoie per ossa .....        | 73          | Bulldog .....                                      | 116                  | pinze per dissezione .....                               | 29           |
| <b>Collin</b> costotomi .....                       | 96          | <b>De Bakey-Semb</b> pinze per legature .....      | 128                  | <b>Harrington-Baby</b> divaricatori .....                | 53           |
| <b>Cone (Adson-Baby)</b> divaricatori .....         | 55          | pinze per legature titanio .....                   | 128                  | <b>Harrington-Pemberton</b> divaricatori .....           | 53           |
| <b>Converse</b> portaghi .....                      | 85          | <b>Derra-De Bakey</b> pinze per anastomosi .....   | 139                  | <b>Hartmann</b> pinze emostatiche .....                  | 26           |
| <b>Cooley</b> dilatatori vascolari .....            | 62          | <b>Desmarres</b> divaricatori .....                | 49                   | <b>Harvey</b> forbici per fili metallici .....           | 76           |
| divaricatori auricolare .....                       | 54          | <b>Dick</b> pinze cardiovascolari atraumatiche ... | 134                  | <b>Hegar</b> portaghi vascolari .....                    | 86           |
| divaricatori costali .....                          | 102, 105    | <b>Diethrich</b> forbici vascolari .....           | 14                   | <b>Hegar-Vascular</b> portaghi .....                     | 86           |
| pinze atraumatiche Bulldog .....                    | 145         | pinze Bulldog .....                                | 35                   | <b>Hegemann (Diethrich)</b> forbici vascolari .....      | 14           |
| pinze cardiovascolari .....                         | 113,        | pinze per dissezione .....                         | 27                   | <b>Heiss</b> pinze per dissezione .....                  | 31           |
| atraumatiche .....                                  | 144 – 156   | pinze per aorta atraumatiche .....                 | 124                  | <b>Henly</b> pinze per subclavia .....                   | 131          |
| pinze per anastomosi .....                          | 149         | portaghi .....                                     | 90                   | <b>Hepp-Scheidel</b> portaghi .....                      | 90           |
| pinze per coartazione .....                         | 146         | Dilatatori vascolari .....                         | 62 – 64              | <b>Horsley</b> pinze cesoie per ossa .....               | 74           |
| pinze per legature .....                            | 151         | Divaricatori .....                                 | 47 – 56              | <b>Ima</b> , pinze Micro-Grip .....                      | 42           |
| pinze per occlusioni tangenziale .....              | 151         | Divaricatore auricolare .....                      | 54                   | <b>Jacobsen</b> micro forbici vascolari .....            | 16           |
| pinze per vari usi .....                            | 147         | costali .....                                      | 99 – 108             | portaghi .....   | 80, 90       |
| <b>Cooley</b> pinze per vari usi atraumatiche       | 147         | per aorta .....                                    | 54                   | <b>Jacobsen-Adson</b> pinze emostatiche .....            | 27           |

# Indice



|   |                      |  |                     |   |           |
|---|----------------------|--|---------------------|---|-----------|
| <b>Jacobsen-Halsted</b> pinze emostatiche.....    | 25                   | <b>Millesi</b> micro-forbici .....                 | 18                  | Pinze-sgorbie.....                                  | 71 – 72   |
| <b>Jameson-Werber</b> forbici .....               | 9                    | <b>Mills</b> forbici vascolari .....               | 21                  | Placche di ricambio .....                           | 158       |
| <b>Javid</b> pinze per la carotide .....          | 144                  | Mini-estrattore per flebo.....                     | 59                  | Portaghi .....                                      | 79 – 90   |
| <b>Jorgensen</b> forbici vascolari.....           | 13                   | <b>Mini-Finocchetto</b> divaricatori costali ..... | 100                 | Micro-Grip.....                                     | 80 – 81   |
| <b>Joseph</b> forbici .....                       | 9                    | <b>Mini-Gemini</b> pinze per dissezione .....      | 32                  | Micro-vascolare .....                               | 81        |
| <b>Kader</b> divaricatori .....                   | 53                   | <b>Mixer</b> pinze per dissezione .....            | 33                  | <b>Potts</b> pinze cardiovascolari atraumatiche..   | 119       |
| spatole per polmone .....                         | 53                   | <b>Mixer-O'Shaugnessy</b> pinze per                |                     | <b>Potts-De-Martel</b> forbici vascolari .....      | 21        |
| <b>Kalt</b> portaghi.....                         | 89                   | dissezione.....                                    | 33                  | <b>Potts-De Bakey</b> pinze cardiovascolari         |           |
| <b>Kantrowitz</b> pinze emostatiche .....         | 29                   | <b>Morris-De Bakey</b> pinze anastomosi aorta      | 135                 | atraumatiche .....                                  | 119       |
| <b>Kelly</b> divaricatori.....                    | 51                   | <b>Morse</b> divaricatori.....                     | 48                  | <b>Potts-Smith</b> forbici vascolari.....           | 10, 13    |
| forbici .....                                     | 8                    | divaricatori costali in alluminio .....            | 106                 | pinze anatomiche.....                               | 45        |
| <b>Klingenberg-Loth</b> forbici vascolari .....   | 13                   | <b>Morse-Favaloro</b> divaricatori costali .....   | 104                 | <b>Price-Thomas</b> pinze per bronchi .....         | 110       |
| <b>Kocher</b> divaricatori .....                  | 49 – 50              | divaricatori costali alluminio .....               | 106                 | Punzonatrice vascolari .....                        | 62        |
| pinze emostatiche.....                            | 24                   | <b>Mosquito</b> pinze cardiovascolari              |                     | <b>Reynolds</b> forbici .....                       | 9         |
| <b>Kocher-Langenbeck</b> divaricatori.....        | 50                   | atraumatiche .....                                 | 137                 | <b>Rienhoff-Finocchetto</b> divaricatori costali    | 102       |
| <b>Krayenbühl</b> uncini .....                    | 61                   | pinze emostatiche atraumatiche.....                | 137                 | <b>Rochester-Pean</b> pinze emostatiche .....       | 24        |
| <b>König</b> divaricatori .....                   | 49                   | <b>Myers</b> sonda per vene.....                   | 58                  | <b>Ross</b> divaricatori per aorta .....            | 54        |
| <b>Lahey (Sweet)</b> pinze per dissezione.....    | 34                   | <b>Müller</b> micro-approssimatori .....           | 39                  | <b>Rudolf (Swedisch-Pattern)</b> portaghi           |           |
| <b>Lambert-Kay</b> pinze anastomosi aorta .....   | 130                  | serrafini .....                                    | 58                  | vascolare .....                                     | 86        |
| <b>Lambotte</b> periostomi.....                   | 68                   | <b>Nabatoff</b> astuccio per le vene.....          | 58                  | <b>Rumel</b> pinze per dissezione.....              | 29        |
| <b>Langenbeck</b> divaricatori .....              | 50                   | <b>Nelson</b> pinze chirurgiche .....              | 46                  | <b>Rumel-Belmont</b> tornichetti .....              | 66        |
| periostomi .....                                  | 68                   | <b>Ochsner</b> pinze per aorta.....                | 124                 | <b>Ruskin-Liston</b> pinze cesoie per ossa.....     | 74        |
| tenaglie per ossa .....                           | 70                   | <b>Ochsner-Kocher</b> pinze emostatiche.....       | 24                  | <b>Ryder</b> portaghi .....                         | 81, 86    |
| <b>Langenbeck-Ryder</b> portaghi .....            | 88                   | <b>Overholt-Geissendörfer</b> pinze per            |                     | <b>Santulli</b> pinze atraumatiche Bulldog .....    | 117       |
| <b>Lawrence</b> pinze per dissezione .....        | 34                   | dissezione.....                                    | 31                  | <b>Sarot</b> pinze emostatiche .....                | 28        |
| <b>Lazar</b> pinze anatomiche .....               | 45                   | <b>Overholt-Mixer</b> pinze per dissezione .....   | 31                  | portaghi.....                                       | 87        |
| <b>Lebsche</b> forbici per sterno .....           | 97                   | <b>Overholt-S</b> pinze per dissezione .....       | 30                  | <b>Satinsky</b> forbici vascolari.....              | 13        |
| <b>Lees</b> pinze per bronchi atraumatiche.....   | 126                  | <b>Overholt-Slim</b> pinze per dissezione .....    | 30                  | pinze cardiovascolari .....                         | 111       |
| <b>Leksell</b> pinze-sgorbie .....                | 72                   | <b>Pean</b> pinze emostatiche .....                | 24                  | <b>Satinsky/De Bakey</b> pinze per occlusione       |           |
| <b>Leland-Jones</b> pinze cardiovascolari         |                      | <b>Pean-De Bakey</b> pinze emostatiche             |                     | tangenziale .....                                   | 129       |
| atraumatiche .....                                | 121                  | atraumatiche .....                                 | 137                 | <b>Sauerbruch</b> divaricatori .....                | 52        |
| <b>Lemmon</b> portaghi .....                      | 87                   | Periostomi.....                                    | 68 – 69             | forbici per sterno.....                             | 96        |
| <b>Leriche</b> pinze emostatiche.....             | 25                   | Pinze anastomosi aorta.....                        | 130                 | pinze-sgorbie .....                                 | 72        |
| <b>Lexer</b> forbici .....                        | 5                    | anatomiche .....                                   | 41 – 46             | <b>Sawtell</b> pinze per dissezione .....           | 33        |
| <b>Lichtenberg</b> portaghi.....                  | 88                   | anatomiche per sutura.....                         | 45                  | Scalpello per sterno.....                           | 97        |
| <b>Liston</b> pinze cesoie per ossa .....         | 73                   | atraumatiche.....                                  | 113 – 156           | Scatole per pinze Bulldog.....                      | 159 – 160 |
| <b>Liston-Key (Horsley)</b> pinze cesoie per      |                      | atraumatiche Bulldog.....                          | 115, 118, 145       | <b>Schmid</b> canule per irrigazione per varici.... | 59        |
| ossa .....  | 74                   | Bulldog.....                                       | 35                  | spatole vascolari .....                             | 60        |
| <b>Little</b> uncini.....                         | 48                   | cardiovascolari atraumatiche .....                 | 112                 | <b>Schwartz</b> pinze .....                         | 35        |
| <b>Love (Morse)</b> divaricatori.....             | 48                   | cardiovascolari.....                               | 109 – 158           | <b>Sellers</b> approssimatore costali.....          | 108       |
| <b>Lovelace</b> pinze per polmone.....            | 110                  | cesoie per ossa.....                               | 73 – 74             | <b>Semb</b> periostomi .....                        | 69        |
| <b>Markwalder</b> pinze-cesoie per ossa.....      | 73                   | chirurgiche a denti di topo .....                  | 46                  | pinze .....   | 110       |
| <b>Martin</b> divaricatori .....                  | 51                   | emostatiche .....                                  | 23 – 28             | pinze cesoie per ossa .....                         | 74        |
| <b>Masson</b> portaghi .....                      | 87                   | klemmer.....                                       | 24                  | pinze-sgorbie .....                                 | 71        |
| <b>Mathieu-Kocher</b> portaghi .....              | 88                   | Micro-Grip.....                                    | 42                  | tenaglie per ossa .....                             | 70        |
| <b>Matson</b> periostomi .....                    | 68                   | Micro-vascolari atraumatiche per                   |                     | <b>Serrafini</b> .....                              | 36 – 39   |
| <b>Mayo</b> forbici (tungsteno).....              | 4 – 5                | prematuri .....                                    | 142                 | <b>Simon</b> divaricatori .....                     | 51        |
| pinze per polmone .....                           | 46                   | per afferrare tessuti.....                         | 45                  | <b>Singley-Tuttle</b> pinze anatomiche .....        | 46        |
| <b>Mayo-Hegar</b> portaghi .....                  | 83, 84               | per afferrare ad embolia .....                     | 63                  | Sonde per endarterectomia.....                      | 59        |
| <b>McIndoe</b> micro-pinze .....                  | 42                   | per afferrare tessuti ed organi.....               | 91 – 93             | per vene.....                                       | 58        |
| pinze anatomiche.....                             | 43                   | per anastomosi .....                               | 120, 123, 143, 135, | Spatole per polmone .....                           | 53, 56    |
| pinze cesoie per ossa .....                       | 73                   | .....  | 136, 139            | vascolari.....                                      | 59 – 61   |
| <b>Mercedes</b> divaricatori costali .....        | 104                  | per aneurisma dell'aorta.....                      | 122 – 123, 136      | <b>Stille</b> costotomi.....                        | 96        |
| <b>Mercedes-Retractor</b> divaricatori costali .. | 104                  | per aorta .....                                    | 28, 124, 127 – 128  | pinze-sgorbie .....                                 | 72        |
| <b>Metzenbaum</b> forbici tungsteno .....         | 4 – 8                | per applicare clips .....                          | 115                 | <b>Stille-Liston</b> pinze cesoie per ossa .....    | 74        |
| <b>Metzenbaum-Fino</b> forbici .....              | 6 – 8                | per bronchi.....                                   | 110, 126            | <b>Stille-Luer</b> Pinze-sgorbie .....              | 71        |
| Micro-Approssimatori.....                         | 39                   | per coartazione.....                               | 119, 136, 146       | <b>Stille-Ruskin</b> Pinze-sgorbie.....             | 71        |
| -clips vascolare .....                            | 36 – 39              | per dissezione coronari .....                      | 33                  | <b>Struck</b> divaricatori costali.....             | 100       |
| -estrattore per vene (flebo) .....                | 59                   | per dissezione e legature.....                     | 26 – 27             | <b>Strully</b> forbici vascolari.....               | 21        |
| -forbici .....                                    | 15 – 20              | per fili .....                                     | 76 – 77             | Strumenti ossea.....                                | 67 – 78   |
| -forbici per le vene .....                        | 18                   | per la carotide.....                               | 144                 | per fili .....                                      | 75 – 78   |
| -forbici per preparazione .....                   | 20                   | per legature.....                                  | 127, 128, 138       | per varici .....                                    | 59        |
| -forbici titanio .....                            | 19                   | per occlusione tangenziale .....                   | 129, 151            | vascolari.....                                      | 57 – 66   |
| -forbici vascolari .....                          | 15 – 21              | per padiglione auricolare .....                    | 125                 | <b>Subranian-Miniature</b> pinze per aorta.....     | 129       |
| -spatole doppie per flebo .....                   | 59                   | per polmone .....                                  | 46, 110             | <b>Swedish Pattern</b> portaghi vascolare .....     | 86        |
| <b>Micro-Grip</b> portaghi .....                  | 80 – 81              | per posizionare micro clips .....                  | 36 – 38             | <b>Sweet (Lahey)</b> pinze per dissezione.....      | 24        |
| <b>Micro-Mosquito</b> pinze emostatiche .....     | 26                   | per preparazioni e legature.....                   | 120                 | Tenaglie per ossa .....                             | 70        |
| <b>Micro-Pinze</b> anatomiche.....                | 42 – 45              | per profondità .....                               | 139                 | tagliafili.....                                     | 78        |
| -pinze con anelli.....                            | 42                   | per subclavia.....                                 | 131                 | <b>Toennis-Adson</b> forbici vascolari .....        | 13        |
| <b>Micro-Pinze</b> per sutura .....               | 45                   | per tumore .....                                   | 44                  | <b>Toennis</b> portaghi.....                        | 88        |
| Micro-portaghi .....                              | 80 – 83, 89 – 90, 93 | per vari usi .....                                 | 133, 138, 147       | spatole .....                                       | 60        |
| <b>Micro-Ryder</b> portaghi vascolare .....       | 86                   | periferiche .....                                  | 139                 | Tornichetti .....                                   | 66        |
| Micro-Serrafini .....                             | 38 – 39              | vascolari atraumatiche.....                        | 109 – 158           | Tronchese tagliafili .....                          | 78        |
| <b>Microvascular</b> portaghi .....               | 81, 86               | vascolari con placche intercambiabili ..           | 158                 | <b>Tubbs</b> dilatatori vascolari .....             | 62        |
| <b>Mikulicz</b> divaricatori .....                | 51                   | Pinze-Micro con anelli .....                       | 42                  | Tubi d'aspirazione.....                             | 66        |

## Indice



|  |             |
|--|-------------|
| Uncini.....                                      | 48 – 50     |
| vascolari.....                                   | 48 – 49, 61 |
| Unico per phlebectomia.....                      | 60          |
| <b>Universal</b> forbici per fili metallici..... | 76          |
| <b>Varady</b> micro-estrattore.....              | 59          |
| strumenti flebo.....                             | 59          |
| <b>Vena-Arteria</b> pinze atraumatiche Bulldog   |             |
| titanio.....                                     | 118         |
| <b>Volkman</b> divaricatori.....                 | 50          |
| <b>Wangensteen</b> pinze anatomiche.....         | 45          |
| portaghi.....                                    | 87          |
| <b>Weber</b> pinze per aorta.....                | 128         |
| <b>Weitlaner</b> divaricatori.....               | 55 – 56     |
| <b>Wertheim</b> pinze per anastomosi.....        | 134         |
| <b>Wickstroem</b> pinze per dissezione.....      | 24          |
| <b>Williams</b> pinze per afferrare tessuti ed   |             |
| organi.....                                      | 92          |
| <b>Wylie</b> pinze per aneurisma dell'aorta..... | 123         |
| <b>Yankauer</b> tubi d'aspirazione.....          | 65          |
| <b>Zenker</b> divaricatori.....                  | 53          |
| <b>Zweifel</b> portaghi.....                     | 88          |



Nummernverzeichnis  
Numerical index  
Indice numérico  
Table numérique  
Indice numerico



Nummernverzeichnis  
 Numerical index  
 Índice numérico  
 Table numérique  
 Índice numerico



| Katalog-Nr..... | Seite  | Katalog-Nr..... | Seite  | Katalog-Nr..... | Seite  | Katalog-Nr..... | Seite  | Katalog-Nr..... | Seite  |
|-----------------|--------|-----------------|--------|-----------------|--------|-----------------|--------|-----------------|--------|
| Cat. no.....    | page   | Cat. no.....    | page   | Cat. no.....    | page   | Cat. no.....    | page   | Cat. no.....    | page   |
| No. ref.....    | página | No. ref.....    | página | No. ref.....    | página | No. ref.....    | página | No. ref.....    | página |
| No. réf.....    | page   | No. réf.....    | page   | No. réf.....    | page   | No. réf.....    | page   | No. réf.....    | page   |
| No. rif.....    | pagina | No. rif.....    | pagina | No. rif.....    | pagina | No. rif.....    | pagina | No. rif.....    | pagina |
| RU 1001-14      | 2      | RU 1331-30      | 7      | RU 1760-16      | 14     | RU 2383-18 TI   | 19     | RU 3111-12      | 25     |
| RU 1001-15      | 2      | RU 1334-18      | 7      | RU 1760-19      | 14     | RU 2385-18      | 19     | RU 3111-12 TI   | 25     |
| RU 1001-16      | 2      | RU 1334-18 MC   | 8      | RU 1761-13      | 14     | RU 2386-16      | 20     | RU 3111-18      | 25     |
| RU 1002-14      | 2      | RU 1334-18 RS   | 4      | RU 1761-16      | 14     | RU 2386-16 TI   | 20     | RU 3111-21      | 25     |
| RU 1002-15      | 2      | RU 1334-20      | 7      | RU 1761-19      | 14     | RU 2387-16      | 20     | RU 3114-13      | 25     |
| RU 1002-16      | 2      | RU 1334-20 MC   | 8      | RU 1762-13      | 14     | RU 2387-16 TI   | 20     | RU 3115-13      | 25     |
| RU 1003-14      | 2      | RU 1334-23      | 7      | RU 1762-16      | 14     | RU 2388-14      | 19     | RU 3120-10      | 26     |
| RU 1003-15      | 2      | RU 1334-23 MC   | 8      | RU 1762-19      | 14     | RU 2389-14      | 20     | RU 3120-12      | 26     |
| RU 1003-16      | 2      | RU 1334-23 RS   | 4      | RU 1763-13      | 14     | RU 2490-21      | 21     | RU 3121-10      | 26     |
| RU 1004-14      | 2      | RU 1334-25      | 7      | RU 1763-16      | 14     | RU 2491-21      | 21     | RU 3121-12      | 26     |
| RU 1006-14      | 2      | RU 1334-26 RS   | 4      | RU 1763-19      | 14     | RU 2496-22      | 21     | RU 3121-12 TI   | 26     |
| RU 1008-14      | 2      | RU 1334-28      | 7      | RU 1764-16      | 14     | RU 2497-22      | 21     | RU 3122-10      | 26     |
| RU 1011-14      | 3      | RU 1334-30      | 7      | RU 1764-19      | 14     | RU 2600-12      | 76     | RU 3122-12      | 26     |
| RU 1011-15      | 3      | RU 1336-18      | 7      | RU 1765-19      | 14     | RU 2601-12      | 76     | RU 3123-10      | 26     |
| RU 1011-16      | 3      | RU 1336-20      | 7      | RU 1770-25      | 15     | RU 2610-12      | 76     | RU 3123-12      | 26     |
| RU 1012-14      | 3      | RU 1336-23      | 7      | RU 1770-45      | 15     | RU 2805-22      | 96     | RU 3123-12 TI   | 26     |
| RU 1012-15      | 3      | RU 1336-25      | 7      | RU 1770-60      | 15     | RU 2820-22      | 96     | RU 3140-10      | 26     |
| RU 1012-16      | 3      | RU 1336-28      | 7      | RU 1770-90      | 15     | RU 2825-21      | 96     | RU 3140-10 TI   | 26     |
| RU 1013-14      | 3      | RU 1339-15      | 8      | RU 1770-99      | 15     | RU 3000-16      | 24     | RU 3141-10      | 26     |
| RU 1013-15      | 3      | RU 1339-18      | 8      | RU 1771-25      | 15     | RU 3000-18      | 24     | RU 3141-10 TI   | 26     |
| RU 1013-16      | 3      | RU 1339-20      | 8      | RU 1771-25 TI   | 15     | RU 3000-20      | 24     | RU 3200-18      | 26     |
| RU 1014-14      | 3      | RU 1339-23      | 8      | RU 1771-45      | 15     | RU 3000-22      | 24     | RU 3201-18      | 26     |
| RU 1016-14      | 3      | RU 1339-26      | 8      | RU 1771-45 TI   | 15     | RU 3000-24      | 24     | RU 3205-14      | 26     |
| RU 1018-14      | 3      | RU 1440-18      | 8      | RU 1771-60      | 15     | RU 3000-26      | 24     | RU 3205-18      | 26     |
| RU 1103-16      | 5      | RU 1441-18      | 8      | RU 1771-60 TI   | 15     | RU 3001-16      | 24     | RU 3206-00      | 27     |
| RU 1103-16 MC   | 5      | RU 1580-15      | 9      | RU 1771-90      | 15     | RU 3001-18      | 24     | RU 3206-18      | 27     |
| RU 1250-14      | 5      | RU 1580-15 MC   | 9      | RU 1771-90 TI   | 15     | RU 3001-20      | 24     | RU 3207-18      | 27     |
| RU 1250-17      | 5      | RU 1580-18      | 9      | RU 1771-99      | 15     | RU 3001-22      | 24     | RU 3208-01      | 27     |
| RU 1250-23      | 5      | RU 1581-15      | 9      | RU 1771-99 TI   | 15     | RU 3001-24      | 24     | RU 3208-02      | 27     |
| RU 1250-28      | 5      | RU 1581-18      | 9      | RU 1772-25      | 15     | RU 3001-26      | 24     | RU 3208-03      | 27     |
| RU 1251-14      | 5      | RU 1582-15 MC   | 9      | RU 1772-45      | 15     | RU 3010-16      | 24     | RU 3208-11      | 27     |
| RU 1251-17      | 5      | RU 1584-13      | 9      | RU 1772-60      | 15     | RU 3010-18      | 24     | RU 3240-20      | 27     |
| RU 1251-23      | 5      | RU 1670-14      | 9      | RU 1772-90      | 15     | RU 3010-20      | 24     | RU 3240-22      | 27     |
| RU 1251-28      | 5      | RU 1671-14      | 9      | RU 1772-99      | 15     | RU 3010-22      | 24     | RU 3240-24      | 27     |
| RU 1252-14      | 5      | RU 1705-11      | 10     | RU 1773-25      | 15     | RU 3010-24      | 24     | RU 3240-26      | 27     |
| RU 1252-17      | 5      | RU 1710-19      | 10     | RU 1773-45      | 15     | RU 3010-26      | 24     | RU 3241-20      | 27     |
| RU 1252-23      | 5      | RU 1713-15      | 10     | RU 1773-60      | 15     | RU 3011-18      | 24     | RU 3241-22      | 27     |
| RU 1253-14      | 5      | RU 1714-15      | 10     | RU 1773-90      | 15     | RU 3011-19      | 24     | RU 3241-24      | 27     |
| RU 1253-14 RS   | 4      | RU 1715-15      | 10     | RU 1773-99      | 15     | RU 3011-20      | 24     | RU 3241-26      | 27     |
| RU 1253-17      | 5      | RU 1718-17 MC   | 11     | RU 1829-17      | 13     | RU 3011-22      | 24     | RU 3242-20      | 27     |
| RU 1253-17 RS   | 4      | RU 1720-19      | 12     | RU 2350-18      | 16     | RU 3011-24      | 24     | RU 3242-22      | 27     |
| RU 1253-23      | 5      | RU 1720-19 MC   | 11     | RU 2350-18 TI   | 16     | RU 3011-26      | 24     | RU 3242-24      | 27     |
| RU 1253-23 RS   | 4      | RU 1721-19      | 12     | RU 2351-18      | 16     | RU 3020-13      | 24     | RU 3242-26      | 27     |
| RU 1291-14      | 6      | RU 1721-19 MC   | 11     | RU 2351-18 TI   | 16     | RU 3020-14      | 24     | RU 3243-20      | 27     |
| RU 1304-14      | 6      | RU 1722-19      | 12     | RU 2352-18      | 16     | RU 3021-13      | 24     | RU 3243-22      | 27     |
| RU 1314-14      | 6      | RU 1722-19 MC   | 11     | RU 2360-19      | 16     | RU 3021-14      | 24     | RU 3243-24      | 27     |
| RU 1314-14 MC   | 8      | RU 1723-19      | 12     | RU 2361-19      | 16     | RU 3030-13      | 24     | RU 3243-26      | 27     |
| RU 1314-14 RS   | 4      | RU 1724-25      | 12     | RU 2362-19      | 16     | RU 3030-14      | 24     | RU 3246-27      | 28     |
| RU 1316-14      | 6      | RU 1724-45      | 12     | RU 2364-19      | 16     | RU 3031-13      | 24     | RU 3247-27      | 28     |
| RU 1324-18      | 7      | RU 1724-60      | 12     | RU 2365-19      | 16     | RU 3031-14      | 24     | RU 3270-24      | 28     |
| RU 1324-20      | 7      | RU 1735-19      | 13     | RU 2370-01/13   | 18     | RU 3080-15      | 25     | RU 3271-24      | 28     |
| RU 1324-23      | 7      | RU 1739-22      | 13     | RU 2370-16      | 17     | RU 3080-15 TI   | 25     | RU 3274-22      | 28     |
| RU 1324-25      | 7      | RU 1740-24      | 13     | RU 2370-18      | 17     | RU 3081-15      | 25     | RU 3274-23      | 28     |
| RU 1324-28      | 7      | RU 1744-23      | 13     | RU 2371-16      | 17     | RU 3081-15 TI   | 25     | RU 3274-24      | 28     |
| RU 1324-30      | 7      | RU 1745-23      | 13     | RU 2371-18      | 17     | RU 3082-15      | 25     | RU 3275-18      | 28     |
| RU 1326-18      | 7      | RU 1750-16      | 14     | RU 2372-16      | 17     | RU 3082-15 TI   | 25     | RU 3275-24      | 28     |
| RU 1326-20      | 7      | RU 1750-23      | 14     | RU 2373-16      | 17     | RU 3083-15      | 25     | RU 3275-24 TI   | 28     |
| RU 1326-23      | 7      | RU 1750-28      | 14     | RU 2375-18      | 17     | RU 3083-15 TI   | 25     | RU 3276-01      | 29     |
| RU 1326-25      | 7      | RU 1752-16      | 14     | RU 2376-16      | 18     | RU 3100-12      | 25     | RU 3276-02      | 29     |
| RU 1326-28      | 7      | RU 1752-23      | 14     | RU 2377-16      | 18     | RU 3100-12 TI   | 25     | RU 3279-19      | 29     |
| RU 1330-18      | 7      | RU 1754-16      | 14     | RU 2380-14      | 19     | RU 3100-18      | 25     | RU 3279-24      | 29     |
| RU 1330-20      | 7      | RU 1754-23      | 14     | RU 2380-16      | 19     | RU 3100-21      | 25     | RU 3279-26      | 29     |
| RU 1330-23      | 7      | RU 1754-28      | 14     | RU 2381-16      | 19     | RU 3101-12      | 25     | RU 3280-01      | 29     |
| RU 1330-25      | 7      | RU 1755-25      | 14     | RU 2382-16      | 19     | RU 3101-12 TI   | 25     | RU 3280-02      | 29     |
| RU 1330-28      | 7      | RU 1755-45      | 14     | RU 2382-18      | 19     | RU 3101-18      | 25     | RU 3280-03      | 29     |
| RU 1331-18      | 7      | RU 1755-60      | 14     | RU 2382-18 TI   | 19     | RU 3101-21      | 25     | RU 3280-04      | 29     |
| RU 1331-20      | 7      | RU 1756-25      | 14     | RU 2382-23      | 19     | RU 3110-12      | 25     | RU 3280-05      | 29     |
| RU 1331-23      | 7      | RU 1756-45      | 14     | RU 2382-23 TI   | 19     | RU 3110-12 TI   | 25     | RU 3290-00/01   | 30     |
| RU 1331-25      | 7      | RU 1756-60      | 14     | RU 2383-16      | 19     | RU 3110-18      | 25     | RU 3290-00/02   | 30     |
| RU 1331-28      | 7      | RU 1760-13      | 14     | RU 2383-18      | 19     | RU 3110-21      | 25     | RU 3290-00/03   | 30     |

# Nummernverzeichnis

## Numerical index

### Indice numérico

#### Table numérique

#### Indice numerico

| Katalog-Nr.....     | Seite  | Katalog-Nr.....   | Seite  | Katalog-Nr.....        | Seite  | Katalog-Nr.....        | Seite  | Katalog-Nr.....  | Seite  |
|---------------------|--------|-------------------|--------|------------------------|--------|------------------------|--------|------------------|--------|
| Cat. no.....        | page   | Cat. no.....      | page   | Cat. no.....           | page   | Cat. no.....           | page   | Cat. no.....     | page   |
| No. ref.....        | página | No. ref.....      | página | No. ref.....           | página | No. ref.....           | página | No. ref.....     | página |
| No. réf.....        | page   | No. réf.....      | page   | No. réf.....           | page   | No. réf.....           | page   | No. réf.....     | page   |
| No. rif.....        | pagina | No. rif.....      | pagina | No. rif.....           | pagina | No. rif.....           | pagina | No. rif.....     | pagina |
| RU 3290-00/04 ..... | 30     | RU 3935-21 .....  | 35     | RU 3975-472 .....      | 37     | RU 4068-58 .....       | 42     | RU 4475-15 ..... | 49     |
| RU 3290-01 .....    | 30     | RU 3935-22 .....  | 35     | RU 3975-473 .....      | 37     | RU 4068-63 .....       | 42     | RU 4475-16 ..... | 49     |
| RU 3290-02 .....    | 30     | RU 3935-23 .....  | 35     | RU 3975-474 .....      | 37     | RU 4068-63 TI .....    | 42     | RU 4475-18 ..... | 49     |
| RU 3290-03 .....    | 30     | RU 3935-60 .....  | 115    | RU 3975-475 .....      | 37     | RU 4068-71 .....       | 42     | RU 4476-13 ..... | 49     |
| RU 3290-04 .....    | 30     | RU 3935-64 .....  | 115    | RU 3975-476 .....      | 37     | RU 4068-72 .....       | 42     | RU 4476-16 ..... | 49     |
| RU 3290-05 .....    | 30     | RU 3935-70 .....  | 115    | RU 3975-477 .....      | 37     | RU 4069-12 .....       | 43     | RU 4480-18 ..... | 49     |
| RU 3291-21 .....    | 31     | RU 3950-04 .....  | 36     | RU 3975-478 .....      | 37     | RU 4069-15 .....       | 43     | RU 4500-01 ..... | 50     |
| RU 3291-27 .....    | 31     | RU 3950-06 .....  | 36     | RU 3975-479 .....      | 37     | RU 4069-18 .....       | 43     | RU 4501-01 ..... | 50     |
| RU 3292-21 .....    | 31     | RU 3950-08 .....  | 36     | RU 3975-480 .....      | 37     | RU 4069-18/04 TI ..... | 44     | RU 4506-24 ..... | 50     |
| RU 3292-27 .....    | 31     | RU 3950-10 .....  | 36     | RU 3975-481 .....      | 37     | RU 4069-18/08 TI ..... | 44     | RU 4522-01 ..... | 50     |
| RU 3293-21 .....    | 31     | RU 3955-04 .....  | 36     | RU 3975-482 .....      | 37     | RU 4070-17 .....       | 43     | RU 4522-02 ..... | 50     |
| RU 3293-27 .....    | 31     | RU 3955-06 .....  | 36     | RU 3975-483 .....      | 37     | RU 4070-17 TI .....    | 43     | RU 4522-05 ..... | 50     |
| RU 3294-21 .....    | 31     | RU 3955-08 .....  | 36     | RU 3975-484 .....      | 37     | RU 4075-00 .....       | 45     | RU 4530-01 ..... | 50     |
| RU 3294-27 .....    | 31     | RU 3955-10 .....  | 36     | RU 3977-010 .....      | 38     | RU 4075-05 .....       | 45     | RU 4530-02 ..... | 50     |
| RU 3295-21 .....    | 31     | RU 3956-06 .....  | 36     | RU 3977-011 .....      | 38     | RU 4075-08 .....       | 45     | RU 4530-03 ..... | 50     |
| RU 3295-27 .....    | 31     | RU 3957-06 .....  | 36     | RU 3977-012 .....      | 38     | RU 4079-18/01 TI ..... | 44     | RU 4530-04 ..... | 50     |
| RU 3296-21 .....    | 31     | RU 3958-06 .....  | 36     | RU 3977-013 .....      | 38     | RU 4079-18/02 TI ..... | 44     | RU 4530-05 ..... | 50     |
| RU 3296-27 .....    | 31     | RU 3960-04 .....  | 36     | RU 3977-014 .....      | 38     | RU 4079-18/03 TI ..... | 44     | RU 4530-06 ..... | 50     |
| RU 3297-21 .....    | 31     | RU 3960-06 .....  | 36     | RU 3977-020 .....      | 38     | RU 4080-17 .....       | 45     | RU 4530-07 ..... | 50     |
| RU 3297-27 .....    | 31     | RU 3960-07 .....  | 36     | RU 3977-021 .....      | 38     | RU 4082-17 .....       | 45     | RU 4536-01 ..... | 50     |
| RU 3298-21 .....    | 31     | RU 3960-08 .....  | 36     | RU 3977-022 .....      | 38     | RU 4083-17 .....       | 45     | RU 4536-02 ..... | 50     |
| RU 3301-20 .....    | 31     | RU 3960-10 .....  | 36     | RU 3977-023 .....      | 38     | RU 4085-15 .....       | 45     | RU 4538-11 ..... | 50     |
| RU 3302-20 .....    | 31     | RU 3966-06 .....  | 36     | RU 3977-024 .....      | 38     | RU 4085-23 .....       | 45     | RU 4538-12 ..... | 50     |
| RU 3303-20 .....    | 31     | RU 3967-06 .....  | 36     | RU 3977-052 .....      | 38     | RU 4085-25 .....       | 45     | RU 4538-13 ..... | 50     |
| RU 3305-20 .....    | 31     | RU 3968-06 .....  | 36     | RU 3977-054 .....      | 38     | RU 4086-18/04 TI ..... | 44     | RU 4538-14 ..... | 50     |
| RU 3306-20 .....    | 31     | RU 3975-071 ..... | 37     | RU 3977-056 .....      | 38     | RU 4086-18/08 TI ..... | 44     | RU 4538-15 ..... | 50     |
| RU 3326-13 .....    | 32     | RU 3975-072 ..... | 37     | RU 3977-058 .....      | 38     | RU 4087-18/04 TI ..... | 44     | RU 4538-16 ..... | 50     |
| RU 3326-18 .....    | 32     | RU 3975-286 ..... | 37     | RU 3977-060 .....      | 39     | RU 4087-18/08 TI ..... | 44     | RU 4538-17 ..... | 50     |
| RU 3326-20 .....    | 32     | RU 3975-287 ..... | 37     | RU 3977-061 .....      | 39     | RU 4092-15 .....       | 45     | RU 4538-18 ..... | 50     |
| RU 3326-23 .....    | 32     | RU 3975-325 ..... | 37     | RU 3977-062 .....      | 39     | RU 4092-18 .....       | 45     | RU 4538-19 ..... | 50     |
| RU 3326-25 .....    | 32     | RU 3975-326 ..... | 37     | RU 3977-111 .....      | 39     | RU 4092-20 .....       | 45     | RU 4538-20 ..... | 50     |
| RU 3326-27 .....    | 32     | RU 3975-327 ..... | 37     | RU 3977-112 .....      | 39     | RU 4092-23 .....       | 45     | RU 4547-01 ..... | 51     |
| RU 3327-18 .....    | 32     | RU 3975-328 ..... | 37     | RU 3977-113 .....      | 39     | RU 4092-25 .....       | 45     | RU 4547-02 ..... | 51     |
| RU 3327-22 .....    | 32     | RU 3975-329 ..... | 37     | RU 3977-114 .....      | 39     | RU 4135-12 .....       | 46     | RU 4560-01 ..... | 51     |
| RU 3327-25 .....    | 32     | RU 3975-330 ..... | 37     | RU 3977-115 .....      | 39     | RU 4135-12 TI .....    | 46     | RU 4560-02 ..... | 51     |
| RU 3327-28 .....    | 32     | RU 3975-396 ..... | 37     | RU 3977-171 .....      | 39     | RU 4136-12 .....       | 46     | RU 4562-26 ..... | 51     |
| RU 3328-01 .....    | 32     | RU 3975-397 ..... | 37     | RU 3977-172 .....      | 39     | RU 4137-12 .....       | 46     | RU 4565-01 ..... | 51     |
| RU 3328-14 .....    | 32     | RU 3975-398 ..... | 37     | RU 3977-173 .....      | 39     | RU 4137-12 TI .....    | 46     | RU 4565-02 ..... | 51     |
| RU 3328-18 .....    | 32     | RU 3975-399 ..... | 37     | RU 3977-174 .....      | 39     | RU 4138-15 .....       | 46     | RU 4565-03 ..... | 51     |
| RU 3329-01 .....    | 33     | RU 3975-400 ..... | 37     | RU 4002-14 .....       | 43     | RU 4138-15 TI .....    | 46     | RU 4567-01 ..... | 51     |
| RU 3329-11 .....    | 33     | RU 3975-401 ..... | 37     | RU 4002-16 .....       | 43     | RU 4170-18 .....       | 46     | RU 4567-02 ..... | 51     |
| RU 3335-15 .....    | 33     | RU 3975-402 ..... | 37     | RU 4002-18 .....       | 43     | RU 4170-18 TI .....    | 46     | RU 4567-51 ..... | 51     |
| RU 3335-19 .....    | 33     | RU 3975-403 ..... | 37     | RU 4002-20 .....       | 43     | RU 4221-23 .....       | 46     | RU 4567-52 ..... | 51     |
| RU 3341-22 .....    | 33     | RU 3975-404 ..... | 37     | RU 4002-25 .....       | 43     | RU 4235-23 .....       | 46     | RU 4568-01 ..... | 52     |
| RU 3342-25 .....    | 33     | RU 3975-405 ..... | 37     | RU 4035-12 .....       | 43     | RU 4236-23 .....       | 46     | RU 4568-02 ..... | 52     |
| RU 3343-28 .....    | 33     | RU 3975-406 ..... | 37     | RU 4035-12 TI .....    | 43     | RU 4425-20 .....       | 61     | RU 4568-03 ..... | 52     |
| RU 3350-22 .....    | 33     | RU 3975-407 ..... | 37     | RU 4036-12 .....       | 43     | RU 4426-01 .....       | 61     | RU 4569-25 ..... | 52     |
| RU 3351-20 .....    | 34     | RU 3975-408 ..... | 37     | RU 4036-15 .....       | 43     | RU 4426-02 .....       | 61     | RU 4570-01 ..... | 52     |
| RU 3355-27 .....    | 34     | RU 3975-409 ..... | 37     | RU 4038-15 .....       | 43     | RU 4449-08 .....       | 48     | RU 4570-02 ..... | 52     |
| RU 3361-19 .....    | 34     | RU 3975-410 ..... | 37     | RU 4038-15 TI .....    | 43     | RU 4449-11 .....       | 48     | RU 4570-03 ..... | 52     |
| RU 3361-23 .....    | 34     | RU 3975-411 ..... | 37     | RU 4062-18/04 TI ..... | 44     | RU 4449-15 .....       | 48     | RU 4570-04 ..... | 52     |
| RU 3930-01 .....    | 35     | RU 3975-412 ..... | 37     | RU 4062-18/08 TI ..... | 44     | RU 4449-17 .....       | 48     | RU 4570-05 ..... | 52     |
| RU 3930-02 .....    | 35     | RU 3975-413 ..... | 37     | RU 4063-18/04 TI ..... | 44     | RU 4449-20 .....       | 48     | RU 4570-06 ..... | 52     |
| RU 3930-03 .....    | 35     | RU 3975-414 ..... | 37     | RU 4063-18/08 TI ..... | 44     | RU 4449-23 .....       | 48     | RU 4570-07 ..... | 52     |
| RU 3932-00 .....    | 35     | RU 3975-415 ..... | 37     | RU 4065-15 .....       | 43     | RU 4455-20 .....       | 48     | RU 4570-08 ..... | 52     |
| RU 3932-04 .....    | 35     | RU 3975-416 ..... | 37     | RU 4065-18 .....       | 43     | RU 4456-10 .....       | 48     | RU 4570-09 ..... | 52     |
| RU 3932-08 .....    | 35     | RU 3975-417 ..... | 37     | RU 4066-13 .....       | 43     | RU 4456-15 .....       | 48     | RU 4571-04 ..... | 53     |
| RU 3932-10 .....    | 35     | RU 3975-418 ..... | 37     | RU 4067-13 .....       | 43     | RU 4456-20 .....       | 48     | RU 4571-07 ..... | 53     |
| RU 3932-14 .....    | 35     | RU 3975-419 ..... | 37     | RU 4068-12 .....       | 43     | RU 4456-30 .....       | 48     | RU 4571-08 ..... | 53     |
| RU 3932-18 .....    | 35     | RU 3975-461 ..... | 37     | RU 4068-15 .....       | 43     | RU 4456-40 .....       | 48     | RU 4571-09 ..... | 53     |
| RU 3934-08 .....    | 35     | RU 3975-462 ..... | 37     | RU 4068-18 .....       | 43     | RU 4456-50 .....       | 48     | RU 4572-00 ..... | 53     |
| RU 3934-12 .....    | 35     | RU 3975-463 ..... | 37     | RU 4068-18/04 TI ..... | 44     | RU 4456-81 .....       | 48     | RU 4572-01 ..... | 53     |
| RU 3934-16 .....    | 35     | RU 3975-464 ..... | 37     | RU 4068-18/08 TI ..... | 44     | RU 4456-82 .....       | 48     | RU 4572-02 ..... | 53     |
| RU 3934-60 .....    | 115    | RU 3975-465 ..... | 37     | RU 4068-51 .....       | 42     | RU 4456-83 .....       | 48     | RU 4572-51 ..... | 53     |
| RU 3934-64 .....    | 115    | RU 3975-466 ..... | 37     | RU 4068-52 .....       | 42     | RU 4475-08 .....       | 49     | RU 4574-01 ..... | 53     |
| RU 3934-70 .....    | 115    | RU 3975-467 ..... | 37     | RU 4068-53 .....       | 42     | RU 4475-10 .....       | 49     | RU 4574-02 ..... | 53     |
| RU 3934-71 .....    | 115    | RU 3975-468 ..... | 37     | RU 4068-54 .....       | 42     | RU 4475-11 .....       | 49     | RU 4574-03 ..... | 53     |
| RU 3935-08 .....    | 35     | RU 3975-469 ..... | 37     | RU 4068-55 .....       | 42     | RU 4475-12 .....       | 49     | RU 4574-04 ..... | 53     |
| RU 3935-12 .....    | 35     | RU 3975-470 ..... | 37     | RU 4068-56 .....       | 42     | RU 4475-13 .....       | 49     | RU 4578-20 ..... | 53     |
| RU 3935-16 .....    | 35     | RU 3975-471 ..... | 37     | RU 4068-57 .....       | 42     | RU 4475-14 .....       | 49     | RU 4578-30 ..... | 53     |



**Nummernverzeichnis**  
**Numerical index**  
**Indice numérico**  
**Table numérique**  
**Indice numerico**



| Katalog-Nr..... | Seite  | Katalog-Nr..... | Seite  | Katalog-Nr.....  | Seite  | Katalog-Nr.....  | Seite  | Katalog-Nr..... | Seite  |
|-----------------|--------|-----------------|--------|------------------|--------|------------------|--------|-----------------|--------|
| Cat. no.....    | page   | Cat. no.....    | page   | Cat. no.....     | page   | Cat. no.....     | page   | Cat. no.....    | page   |
| No. ref.....    | página | No. ref.....    | página | No. ref.....     | página | No. ref.....     | página | No. ref.....    | página |
| No. réf.....    | page   | No. réf.....    | page   | No. réf.....     | page   | No. réf.....     | page   | No. réf.....    | page   |
| No. rif.....    | pagina | No. rif.....    | pagina | No. rif.....     | pagina | No. rif.....     | pagina | No. rif.....    | pagina |
| RU 4578-40      | 53     | RU 4956-02      | 59     | RU 5701-15       | 73     | RU 5846-53       | 80     | RU 6050-20      | 83     |
| RU 4590-01      | 54     | RU 4956-03      | 59     | RU 5702-17       | 73     | RU 5846-53 TI    | 80     | RU 6050-20 TI   | 83     |
| RU 4590-02      | 54     | RU 4956-04      | 59     | RU 5710-18       | 74     | RU 5846-54       | 80     | RU 6050-24      | 83     |
| RU 4591-01      | 54     | RU 4956-05      | 59     | RU 5711-18       | 74     | RU 5846-54 TI    | 80     | RU 6050-26      | 83     |
| RU 4591-02      | 54     | RU 4956-06      | 59     | RU 5716-23       | 74     | RU 5846-55       | 80     | RU 6050-30      | 83     |
| RU 4591-03      | 54     | RU 4956-20      | 60     | RU 5716-27       | 74     | RU 5846-55 TI    | 80     | RU 6051-20      | 84     |
| RU 4593-01      | 54     | RU 4956-30      | 60     | RU 5717-23       | 74     | RU 5846-62       | 80     | RU 6051-24      | 84     |
| RU 4593-02      | 54     | RU 5260-01      | 65     | RU 5717-27       | 74     | RU 5846-62 TI    | 80     | RU 6051-26      | 84     |
| RU 4593-03      | 54     | RU 5260-27      | 65     | RU 5718-27       | 74     | RU 5846-63       | 80     | RU 6051-30      | 84     |
| RU 4593-04      | 54     | RU 5267-01      | 65     | RU 5719-25       | 74     | RU 5846-63 TI    | 80     | RU 6053-20      | 84     |
| RU 4593-05      | 54     | RU 5268-16      | 65     | RU 5760-14       | 76     | RU 5846-64       | 80     | RU 6053-24      | 84     |
| RU 4593-06      | 54     | RU 5268-27      | 65     | RU 5761-00/18    | 76     | RU 5846-64 TI    | 80     | RU 6054-18      | 84     |
| RU 4593-21      | 54     | RU 5383-19      | 68     | RU 5761-00/20    | 76     | RU 5846-65       | 80     | RU 6054-18 TI   | 84     |
| RU 4593-22      | 54     | RU 5384-18      | 68     | RU 5761-10/15    | 77     | RU 5846-65 TI    | 80     | RU 6054-20      | 84     |
| RU 4593-23      | 54     | RU 5385-05      | 68     | RU 5761-10/20    | 77     | RU 5847-01 TI    | 81     | RU 6054-20 TI   | 84     |
| RU 4593-24      | 54     | RU 5385-10      | 68     | RU 5761-11/15    | 77     | RU 5847-02 TI    | 81     | RU 6054-23      | 84     |
| RU 4593-25      | 54     | RU 5385-15      | 68     | RU 5761-18       | 77     | RU 5847-03 TI    | 81     | RU 6054-23 TI   | 84     |
| RU 4593-26      | 54     | RU 5385-20      | 68     | RU 5761-18/01    | 77     | RU 5847-11 TI    | 81     | RU 6054-26      | 84     |
| RU 4650-07      | 55     | RU 5385-25      | 68     | RU 5761-18/02    | 77     | RU 5847-12 TI    | 81     | RU 6054-26 TI   | 84     |
| RU 4650-10      | 55     | RU 5387-20      | 68     | RU 5761-20/17    | 77     | RU 5847-13 TI    | 81     | RU 6054-31      | 84     |
| RU 4651-07      | 55     | RU 5389-29      | 68     | RU 5761-30/01    | 77     | RU 5847-14 TI    | 81     | RU 6054-68      | 84     |
| RU 4651-10      | 55     | RU 5397-22      | 68     | RU 5761-30/02    | 77     | RU 5847-21 TI    | 81     | RU 6054-70      | 84     |
| RU 4700-13      | 55     | RU 5398-01      | 69     | RU 5761-30/03    | 77     | RU 5847-22 TI    | 81     | RU 6054-73      | 84     |
| RU 4700-16      | 55     | RU 5398-02      | 69     | RU 5766-12       | 78     | RU 5847-23 TI    | 81     | RU 6054-76      | 84     |
| RU 4701-13      | 55     | RU 5398-03      | 69     | RU 5767-18       | 78     | RU 5847-24 TI    | 81     | RU 6054-81      | 84     |
| RU 4701-16      | 55     | RU 5398-04      | 69     | RU 5778-02       | 76     | RU 5847-25 TI    | 81     | RU 6054-89      | 85     |
| RU 4722-13      | 55     | RU 5398-05      | 69     | RU 5778-03       | 76     | RU 5850-15       | 82     | RU 6054-94      | 85     |
| RU 4722-16      | 55     | RU 5398-06      | 69     | RU 5778-04       | 76     | RU 5850-18       | 82     | RU 6055-01      | 85     |
| RU 4723-13      | 55     | RU 5398-07      | 69     | RU 5778-05       | 76     | RU 5851-15       | 82     | RU 6055-15/1    | 85     |
| RU 4723-16      | 55     | RU 5400-01      | 69     | RU 5778-06       | 76     | RU 5851-18       | 82     | RU 6055-15/2    | 85     |
| RU 4724-20      | 56     | RU 5400-02      | 69     | RU 5778-07       | 76     | RU 5852-18       | 82     | RU 6055-18      | 85     |
| RU 4724-25      | 56     | RU 5401-01      | 69     | RU 5778-08       | 76     | RU 5856-18       | 82     | RU 6055-20      | 85     |
| RU 4725-20      | 56     | RU 5401-02      | 69     | RU 5778-09       | 76     | RU 5856-23       | 82     | RU 6055-23      | 85     |
| RU 4725-25      | 56     | RU 5402-01      | 69     | RU 5778-10       | 76     | RU 5857-18       | 82     | RU 6055-26      | 85     |
| RU 4726-25      | 56     | RU 5402-02      | 69     | RU 5778-12       | 76     | RU 5857-23       | 82     | RU 6055-31      | 85     |
| RU 4727-25      | 56     | RU 5514-21      | 70     | RU 5778-15       | 76     | RU 5860-12       | 82     | RU 6056-13/1    | 85     |
| RU 4743-33      | 55     | RU 5516-21      | 70     | RU 5846-02       | 80     | RU 5860-15       | 82     | RU 6056-13/1 TI | 85     |
| RU 4950-00      | 58     | RU 5525-19      | 70     | RU 5846-03       | 80     | RU 5860-15/14 TI | 83     | RU 6056-13/2    | 85     |
| RU 4950-10      | 58     | RU 5525-51      | 70     | RU 5846-04       | 80     | RU 5860-15/08 TI | 83     | RU 6057-12      | 85     |
| RU 4950-11      | 58     | RU 5600-22      | 71     | RU 5846-05       | 80     | RU 5860-18       | 82     | RU 6059-01/14   | 86     |
| RU 4950-12      | 58     | RU 5600-27      | 71     | RU 5846-11/00    | 80     | RU 5860-18/04 TI | 83     | RU 6059-01/18   | 86     |
| RU 4950-23      | 58     | RU 5601-22      | 71     | RU 5846-14/01    | 80     | RU 5860-18/08 TI | 83     | RU 6059-01/20   | 86     |
| RU 4950-26      | 58     | RU 5601-27      | 71     | RU 5846-14/02    | 80     | RU 5860-21/04 TI | 83     | RU 6059-01/23   | 86     |
| RU 4950-29      | 58     | RU 5602-23      | 71     | RU 5846-14/03    | 80     | RU 5860-21/08 TI | 83     | RU 6059-05/14   | 86     |
| RU 4950-32      | 58     | RU 5604-23      | 71     | RU 5846-18/00    | 80     | RU 5860-23       | 82     | RU 6059-05/18   | 86     |
| RU 4950-35      | 58     | RU 5605-02      | 72     | RU 5846-18/00 TI | 80     | RU 5861-12       | 82     | RU 6059-05/20   | 86     |
| RU 4951-06      | 58     | RU 5605-03      | 72     | RU 5846-18/01    | 80     | RU 5861-15       | 82     | RU 6059-05/23   | 86     |
| RU 4951-09      | 58     | RU 5605-04      | 72     | RU 5846-18/01 TI | 80     | RU 5861-15/04 TI | 83     | RU 6059-13      | 86     |
| RU 4951-12      | 58     | RU 5606-03      | 72     | RU 5846-18/02    | 80     | RU 5861-15/08 TI | 83     | RU 6059-16      | 86     |
| RU 4951-15      | 58     | RU 5606-04      | 72     | RU 5846-18/02 TI | 80     | RU 5861-18       | 82     | RU 6059-18      | 86     |
| RU 4952-00      | 59     | RU 5606-06      | 72     | RU 5846-18/03    | 80     | RU 5861-18/04 TI | 83     | RU 6059-20      | 86     |
| RU 4952-02      | 59     | RU 5606-08      | 72     | RU 5846-18/03 TI | 80     | RU 5861-18/08 TI | 83     | RU 6059-23      | 86     |
| RU 4952-03      | 59     | RU 5607-23      | 72     | RU 5846-21/00    | 80     | RU 5861-21/04 TI | 83     | RU 6059-26      | 86     |
| RU 4952-04      | 59     | RU 5608-23      | 72     | RU 5846-21/00 TI | 80     | RU 5861-21/08 TI | 83     | RU 6059-63      | 86     |
| RU 4952-06      | 59     | RU 5610-29      | 72     | RU 5846-21/01    | 80     | RU 5861-23       | 82     | RU 6059-65      | 86     |
| RU 4952-07      | 59     | RU 5611-29      | 72     | RU 5846-21/01 TI | 80     | RU 5863-12       | 82     | RU 6059-65 TI   | 86     |
| RU 4952-08      | 59     | RU 5616-34      | 72     | RU 5846-21/02    | 80     | RU 5864-12       | 82     | RU 6059-68      | 86     |
| RU 4952-10      | 59     | RU 5635-20      | 73     | RU 5846-21/02 TI | 80     | RU 5864-15       | 82     | RU 6059-68 TI   | 86     |
| RU 4952-12      | 59     | RU 5640-14      | 73     | RU 5846-21/03    | 80     | RU 5864-18       | 82     | RU 6059-70      | 86     |
| RU 4952-14      | 59     | RU 5640-17      | 73     | RU 5846-21/03 TI | 80     | RU 5865-12       | 82     | RU 6059-70 TI   | 86     |
| RU 4954-03      | 59     | RU 5640-19      | 73     | RU 5846-23/00    | 80     | RU 5865-15       | 82     | RU 6059-73      | 86     |
| RU 4954-04      | 59     | RU 5640-22      | 73     | RU 5846-23/00 TI | 80     | RU 5865-18       | 82     | RU 6059-76      | 86     |
| RU 4954-05      | 59     | RU 5641-14      | 73     | RU 5846-23/01    | 80     | RU 5867-12       | 82     | RU 6060-00/15   | 86     |
| RU 4954-06      | 59     | RU 5641-17      | 73     | RU 5846-23/01 TI | 80     | RU 6049-20       | 83     | RU 6060-00/17   | 86     |
| RU 4955-03/14   | 60     | RU 5641-19      | 73     | RU 5846-23/02    | 80     | RU 6049-24       | 83     | RU 6060-00/20   | 86     |
| RU 4955-03/24   | 60     | RU 5641-22      | 73     | RU 5846-23/02 TI | 80     | RU 6049-26       | 83     | RU 6060-05/14   | 87     |
| RU 4955-05/23   | 60     | RU 5643-15      | 73     | RU 5846-23/03    | 80     | RU 6050-16       | 83     | RU 6060-05/16   | 87     |
| RU 4955-10/15   | 60     | RU 5648-13      | 73     | RU 5846-23/03 TI | 80     | RU 6050-16 TI    | 83     | RU 6060-05/18   | 87     |
| RU 4955-10/21   | 60     | RU 5648-17      | 73     | RU 5846-52       | 80     | RU 6050-18       | 83     | RU 6060-05/20   | 87     |
| RU 4956-01      | 59     | RU 5700-15      | 73     | RU 5846-52 TI    | 80     | RU 6050-18 TI    | 83     | RU 6060-05/24   | 87     |



# Nummernverzeichnis

## Numerical index

### Indice numérico

### Table numérique

### Indice numerico

| Katalog-Nr..... | Seite  | Katalog-Nr..... | Seite  | Katalog-Nr.....  | Seite  | Katalog-Nr.....  | Seite  | Katalog-Nr..... | Seite  |
|-----------------|--------|-----------------|--------|------------------|--------|------------------|--------|-----------------|--------|
| Cat. no.....    | page   | Cat. no.....    | page   | Cat. no.....     | page   | Cat. no.....     | page   | Cat. no.....    | page   |
| No. ref.....    | página | No. ref.....    | página | No. ref.....     | página | No. ref.....     | página | No. ref.....    | página |
| No. réf.....    | page   | No. réf.....    | page   | No. réf.....     | page   | No. réf.....     | page   | No. réf.....    | page   |
| No. rif.....    | pagina | No. rif.....    | pagina | No. rif.....     | pagina | No. rif.....     | pagina | No. rif.....    | pagina |
| RU 6060-05/26   | 87     | RU 6421-07      | 65     | RU 7521-10       | 103    | RU 7575-20/18 TI | 113    | RU 7587-12 TI   | 115    |
| RU 6060-05/28   | 87     | RU 6421-08      | 65     | RU 7521-21       | 103    | RU 7575-20/21    | 113    | RU 7588-06      | 116    |
| RU 6060-05/30   | 87     | RU 6421-09      | 65     | RU 7521-22       | 103    | RU 7576-15       | 113    | RU 7588-07      | 116    |
| RU 6060-07/14   | 87     | RU 6421-10      | 65     | RU 7521-23       | 103    | RU 7576-18       | 113    | RU 7588-09      | 116    |
| RU 6060-07/17   | 87     | RU 6421-11      | 65     | RU 7522-01       | 104    | RU 7576-25       | 113    | RU 7588-11      | 116    |
| RU 6060-07/19   | 87     | RU 6421-12      | 65     | RU 7522-02       | 104    | RU 7576-29       | 113    | RU 7589-06      | 116    |
| RU 6060-18      | 87     | RU 6421-34      | 65     | RU 7523-00       | 104    | RU 7576-34       | 113    | RU 7589-07      | 116    |
| RU 6060-26      | 87     | RU 6505-16      | 92     | RU 7523-10       | 104    | RU 7577-18       | 113    | RU 7589-09      | 116    |
| RU 6062-27      | 87     | RU 6505-20      | 92     | RU 7523-21       | 104    | RU 7577-20       | 113    | RU 7589-11      | 116    |
| RU 6063-27      | 87     | RU 6505-25      | 92     | RU 7523-22       | 104    | RU 7579-15       | 113    | RU 7590-05      | 116    |
| RU 6064-20      | 88     | RU 6505-30      | 92     | RU 7524-01       | 105    | RU 7579-19       | 113    | RU 7590-07      | 116    |
| RU 6064-27      | 88     | RU 6514-16      | 92     | RU 7524-02       | 105    | RU 7580-10/15 TI | 114    | RU 7590-09      | 117    |
| RU 6067-18/00   | 88     | RU 6517-16      | 92     | RU 7524-04       | 105    | RU 7580-10/19 TI | 114    | RU 7590-10      | 117    |
| RU 6068-20      | 88     | RU 6517-20      | 92     | RU 7524-11       | 105    | RU 7580-10/24 TI | 114    | RU 7591-01      | 117    |
| RU 6069-18      | 88     | RU 6518-16      | 92     | RU 7524-21       | 105    | RU 7580-15/15 TI | 114    | RU 7591-02      | 117    |
| RU 6070-14      | 88     | RU 6518-18      | 92     | RU 7525-01       | 106    | RU 7580-15/19 TI | 114    | RU 7591-07      | 117    |
| RU 6070-17      | 88     | RU 6518-20      | 92     | RU 7525-02       | 106    | RU 7580-15/24 TI | 114    | RU 7591-07 TI   | 117    |
| RU 6070-20      | 88     | RU 6518-24      | 92     | RU 7525-03       | 106    | RU 7580-16       | 114    | RU 7591-09      | 117    |
| RU 6071-02/20   | 88     | RU 6520-18      | 93     | RU 7526-01       | 106    | RU 7580-18/15 TI | 114    | RU 7591-11      | 117    |
| RU 6071-02/23   | 88     | RU 6520-20      | 93     | RU 7526-02       | 106    | RU 7580-18/19 TI | 114    | RU 7591-92      | 117    |
| RU 6071-20      | 89     | RU 6521-18      | 93     | RU 7526-11       | 106    | RU 7580-18/24 TI | 114    | RU 7591-94      | 117    |
| RU 6071-25      | 89     | RU 6521-20      | 93     | RU 7526-12       | 106    | RU 7580-20       | 114    | RU 7592-02/30 A | 118    |
| RU 6082-14      | 89     | RU 6521-23      | 93     | RU 7527-01       | 107    | RU 7580-20/15 TI | 114    | RU 7592-02/30 V | 118    |
| RU 6082-14/1    | 89     | RU 6522-20      | 93     | RU 7527-02       | 107    | RU 7580-20/19 TI | 114    | RU 7592-02/35 A | 118    |
| RU 6082-14/2    | 89     | RU 6522-23      | 93     | RU 7527-11       | 107    | RU 7580-20/24 TI | 114    | RU 7592-02/35 V | 118    |
| RU 6082-18      | 89     | RU 6523-20      | 93     | RU 7527-12       | 107    | RU 7580-24       | 114    | RU 7592-02/40 A | 118    |
| RU 6082-18/1    | 89     | RU 6525-25      | 93     | RU 7527-13       | 107    | RU 7580-28/15 TI | 114    | RU 7592-02/40 V | 118    |
| RU 6082-18/2    | 89     | RU 6525-26      | 93     | RU 7528-00       | 107    | RU 7580-28/19 TI | 114    | RU 7592-02/50 A | 118    |
| RU 6082-18/2 TI | 89     | RU 6650-20      | 63     | RU 7528-01       | 107    | RU 7580-28/24 TI | 114    | RU 7592-02/50 V | 118    |
| RU 6082-21/1    | 89     | RU 7500-26      | 96     | RU 7528-02       | 107    | RU 7580-30       | 114    | RU 7592-03/30 A | 118    |
| RU 6082-21/2    | 89     | RU 7501-27      | 96     | RU 7528-03       | 107    | RU 7581-16       | 114    | RU 7592-03/30 V | 118    |
| RU 6082-21/2 TI | 89     | RU 7504-34      | 97     | RU 7530-00 TI    | 108    | RU 7581-20       | 114    | RU 7592-03/35 A | 118    |
| RU 6082-22      | 89     | RU 7505-32      | 97     | RU 7533-19       | 108    | RU 7581-24       | 114    | RU 7592-03/35 V | 118    |
| RU 6083-14/1    | 89     | RU 7506-32      | 97     | RU 7534-14       | 108    | RU 7581-30       | 114    | RU 7592-03/40 A | 118    |
| RU 6083-14/2    | 89     | RU 7507-24      | 97     | RU 7536-16       | 108    | RU 7582-16       | 114    | RU 7592-03/40 V | 118    |
| RU 6083-18/1    | 89     | RU 7509-00      | 100    | RU 7537-16       | 108    | RU 7582-20       | 114    | RU 7592-03/50 A | 118    |
| RU 6083-18/2    | 89     | RU 7510-00      | 100    | RU 7538-25       | 56     | RU 7582-24       | 114    | RU 7592-03/50 V | 118    |
| RU 6083-21/1    | 89     | RU 7510-05      | 100    | RU 7538-30       | 56     | RU 7582-30       | 114    | RU 7592-05/30 A | 118    |
| RU 6083-21/2    | 89     | RU 7511-00      | 100    | RU 7540-01       | 110    | RU 7583-16       | 114    | RU 7592-05/30 V | 118    |
| RU 6084-14/1    | 89     | RU 7511-10      | 100    | RU 7540-02       | 110    | RU 7583-20       | 114    | RU 7592-05/35 A | 118    |
| RU 6084-14/2    | 89     | RU 7511-15      | 100    | RU 7540-22       | 110    | RU 7583-24       | 114    | RU 7592-05/35 V | 118    |
| RU 6085-14      | 90     | RU 7511-16      | 100    | RU 7548-24       | 110    | RU 7583-30       | 114    | RU 7592-05/40 A | 118    |
| RU 6086-13      | 90     | RU 7511-17      | 100    | RU 7549-24       | 110    | RU 7584-16       | 114    | RU 7592-05/40 V | 118    |
| RU 6087-18/1    | 90     | RU 7511-18      | 100    | RU 7560-20       | 110    | RU 7584-20       | 114    | RU 7592-05/50 A | 118    |
| RU 6087-18/2    | 90     | RU 7511-19      | 100    | RU 7561-20       | 110    | RU 7584-24       | 114    | RU 7592-05/50 V | 118    |
| RU 6090-18      | 90     | RU 7512-01      | 101    | RU 7566-01       | 111    | RU 7584-30       | 114    | RU 7599-00      | 119    |
| RU 6090-20      | 90     | RU 7512-03      | 101    | RU 7566-02       | 111    | RU 7585-12       | 113    | RU 7600-21      | 119    |
| RU 6090-23      | 90     | RU 7512-04      | 101    | RU 7567-01       | 111    | RU 7585-15       | 113    | RU 7600-21 TI   | 119    |
| RU 6092-16      | 90     | RU 7512-05      | 101    | RU 7567-02       | 111    | RU 7586-00       | 115    | RU 7600-22      | 119    |
| RU 6092-18      | 90     | RU 7512-06      | 101    | RU 7568-15       | 111    | RU 7586-07       | 115    | RU 7600-22 TI   | 119    |
| RU 6092-20      | 90     | RU 7512-07      | 101    | RU 7570-01       | 111    | RU 7586-07 TI    | 115    | RU 7600-26      | 119    |
| RU 6092-23      | 90     | RU 7512-08      | 101    | RU 7570-02       | 111    | RU 7586-08       | 115    | RU 7601-21      | 119    |
| RU 6092-25      | 90     | RU 7513-01      | 101    | RU 7570-03       | 111    | RU 7586-08 TI    | 115    | RU 7601-21 TI   | 119    |
| RU 6093-16      | 90     | RU 7513-02      | 101    | RU 7570-04       | 111    | RU 7586-10       | 115    | RU 7601-22      | 119    |
| RU 6093-18      | 90     | RU 7513-03      | 101    | RU 7571-15/15    | 113    | RU 7586-10/35    | 35     | RU 7601-22 TI   | 119    |
| RU 6093-20      | 90     | RU 7513-40      | 101    | RU 7571-15/19    | 113    | RU 7586-10/45    | 35     | RU 7601-26      | 119    |
| RU 6093-23      | 90     | RU 7513-41      | 101    | RU 7571-15/24    | 113    | RU 7586-10/50    | 116    | RU 7602-21      | 119    |
| RU 6093-25      | 90     | RU 7516-00      | 102    | RU 7571-20/15    | 113    | RU 7586-10 TI    | 115    | RU 7602-22      | 119    |
| RU 6342-24      | 60     | RU 7516-05      | 102    | RU 7571-20/19    | 113    | RU 7586-11/35    | 35     | RU 7603-21      | 120    |
| RU 6344-25      | 60     | RU 7518-01      | 102    | RU 7571-20/24    | 113    | RU 7586-11/45    | 35     | RU 7603-21 TI   | 120    |
| RU 6344-25/01   | 60     | RU 7518-02      | 102    | RU 7571-27/15    | 113    | RU 7586-11/50    | 116    | RU 7604-21      | 120    |
| RU 6420-06      | 65     | RU 7518-03      | 102    | RU 7571-27/19    | 113    | RU 7586-12       | 115    | RU 7604-21 TI   | 120    |
| RU 6420-07      | 65     | RU 7520-00      | 103    | RU 7571-27/24    | 113    | RU 7586-12 TI    | 115    | RU 7604-24      | 120    |
| RU 6420-08      | 65     | RU 7520-10      | 103    | RU 7571-35/15    | 113    | RU 7587-07       | 115    | RU 7605-20      | 120    |
| RU 6420-09      | 65     | RU 7520-21      | 103    | RU 7571-35/19    | 113    | RU 7587-07 TI    | 115    | RU 7605-24      | 120    |
| RU 6420-10      | 65     | RU 7520-22      | 103    | RU 7571-35/24    | 113    | RU 7587-08       | 115    | RU 7609-19      | 120    |
| RU 6420-11      | 65     | RU 7520-23      | 103    | RU 7575-12/18    | 113    | RU 7587-08 TI    | 115    | RU 7609-19 TI   | 120    |
| RU 6420-12      | 65     | RU 7520-24      | 103    | RU 7575-12/18 TI | 113    | RU 7587-10       | 115    | RU 7609-20      | 120    |
| RU 6420-15      | 65     | RU 7520-25      | 103    | RU 7575-12/21    | 113    | RU 7587-10 TI    | 115    | RU 7609-20 TI   | 120    |
| RU 6421-06      | 65     | RU 7521-00      | 103    | RU 7575-20/18    | 113    | RU 7587-12       | 115    | RU 7610-01      | 121    |

**Nummernverzeichnis  
Numerical index  
Indice numérico  
Table numérique  
Indice numerico**



| Katalog-Nr. .... | Seite  | Katalog-Nr. .... | Seite  | Katalog-Nr. .... | Seite  | Katalog-Nr. .... | Seite  | Katalog-Nr. .... | Seite  |
|------------------|--------|------------------|--------|------------------|--------|------------------|--------|------------------|--------|
| Cat. no. ....    | page   | Cat. no. ....    | page   | Cat. no. ....    | page   | Cat. no. ....    | page   | Cat. no. ....    | page   |
| No. ref. ....    | página | No. ref. ....    | página | No. ref. ....    | página | No. ref. ....    | página | No. ref. ....    | página |
| No. réf. ....    | page   | No. réf. ....    | page   | No. réf. ....    | page   | No. réf. ....    | page   | No. réf. ....    | page   |
| No. rif. ....    | pagina | No. rif. ....    | pagina | No. rif. ....    | pagina | No. rif. ....    | pagina | No. rif. ....    | pagina |
| RU 7610-01 TI    | 121    | RU 7657-30       | 132    | RU 7699-15       | 139    | RU 7726-20 TI    | 147    | RU 7756-05       | 154    |
| RU 7610-02       | 121    | RU 7657-45       | 132    | RU 7699-15 TI    | 139    | RU 7726-27       | 147    | RU 7756-06       | 154    |
| RU 7610-02 TI    | 121    | RU 7657-90       | 132    | RU 7701-12       | 140    | RU 7726-27 TI    | 147    | RU 7756-07       | 154    |
| RU 7610-03       | 121    | RU 7658-00       | 132    | RU 7702-11       | 140    | RU 7728-17       | 147    | RU 7756-08       | 154    |
| RU 7610-03 TI    | 121    | RU 7658-15       | 132    | RU 7703-12       | 140    | RU 7728-17 TI    | 147    | RU 7756-09       | 154    |
| RU 7611-18       | 121    | RU 7658-30       | 132    | RU 7704-13       | 140    | RU 7729-15       | 147    | RU 7756-13       | 155    |
| RU 7611-18 TI    | 121    | RU 7658-45       | 132    | RU 7705-10       | 140    | RU 7729-15 TI    | 147    | RU 7756-15       | 155    |
| RU 7612-15       | 121    | RU 7658-90       | 132    | RU 7706-01       | 141    | RU 7730-15       | 147    | RU 7756-16       | 155    |
| RU 7612-18       | 121    | RU 7660-20       | 133    | RU 7706-01 TI    | 141    | RU 7730-15 TI    | 147    | RU 7756-17       | 155    |
| RU 7613-15       | 121    | RU 7661-22       | 133    | RU 7706-03       | 141    | RU 7731-01       | 148    | RU 7756-18       | 155    |
| RU 7613-18       | 121    | RU 7661-24       | 133    | RU 7706-03 TI    | 141    | RU 7731-04       | 148    | RU 7756-19       | 155    |
| RU 7615-20       | 121    | RU 7661-30       | 133    | RU 7706-05       | 141    | RU 7731-05       | 148    | RU 7757-01       | 154    |
| RU 7618-24       | 122    | RU 7662-18       | 133    | RU 7706-05 TI    | 141    | RU 7734-17       | 148    | RU 7757-02       | 154    |
| RU 7618-24 TI    | 122    | RU 7662-19       | 133    | RU 7706-08       | 141    | RU 7735-16       | 149    | RU 7757-03       | 154    |
| RU 7618-27       | 122    | RU 7662-23       | 133    | RU 7706-08 TI    | 141    | RU 7736-16       | 149    | RU 7757-04       | 154    |
| RU 7618-27 TI    | 122    | RU 7662-27       | 133    | RU 7706-09       | 141    | RU 7737-17       | 149    | RU 7757-05       | 154    |
| RU 7618-31       | 122    | RU 7663-06       | 134    | RU 7706-09 TI    | 141    | RU 7738-17       | 149    | RU 7757-06       | 154    |
| RU 7618-31 TI    | 122    | RU 7663-08       | 134    | RU 7706-10       | 141    | RU 7739-01       | 149    | RU 7757-07       | 154    |
| RU 7618-33       | 122    | RU 7663-10       | 134    | RU 7706-10 TI    | 141    | RU 7739-03       | 149    | RU 7757-08       | 154    |
| RU 7618-33 TI    | 122    | RU 7663-25       | 134    | RU 7706-13       | 141    | RU 7739-05       | 149    | RU 7757-09       | 154    |
| RU 7619-01       | 123    | RU 7663-26       | 134    | RU 7706-13 TI    | 141    | RU 7739-07       | 149    | RU 7757-11       | 155    |
| RU 7620-28       | 123    | RU 7663-27       | 134    | RU 7706-15       | 141    | RU 7739-22       | 150    | RU 7757-12       | 155    |
| RU 7621-30       | 123    | RU 7664-20       | 135    | RU 7706-15 TI    | 141    | RU 7739-26       | 150    | RU 7757-13       | 155    |
| RU 7624-23       | 124    | RU 7664-23       | 135    | RU 7708-50       | 142    | RU 7740-16       | 150    | RU 7757-14       | 155    |
| RU 7625-21       | 124    | RU 7664-25       | 135    | RU 7708-50 TI    | 142    | RU 7741-17       | 150    | RU 7757-15       | 155    |
| RU 7627-01       | 125    | RU 7665-24       | 135    | RU 7708-52       | 142    | RU 7745-01       | 151    | RU 7757-16       | 155    |
| RU 7627-02       | 125    | RU 7668-24       | 136    | RU 7708-52 TI    | 142    | RU 7745-02       | 151    | RU 7757-17       | 155    |
| RU 7627-03       | 125    | RU 7668-25       | 136    | RU 7708-54       | 142    | RU 7745-03       | 151    | RU 7757-18       | 155    |
| RU 7627-04       | 125    | RU 7668-26       | 136    | RU 7708-54 TI    | 142    | RU 7745-04       | 151    | RU 7757-19       | 155    |
| RU 7629-23       | 126    | RU 7670-21       | 136    | RU 7708-56       | 142    | RU 7745-05       | 151    | RU 7759-01       | 157    |
| RU 7629-23 TI    | 126    | RU 7670-23       | 136    | RU 7708-56 TI    | 142    | RU 7750-16       | 151    | RU 7759-02       | 157    |
| RU 7629-25       | 126    | RU 7670-27       | 136    | RU 7708-58       | 142    | RU 7750-17       | 151    | RU 7759-03       | 157    |
| RU 7630-25       | 126    | RU 7670-31       | 136    | RU 7708-58 TI    | 142    | RU 7750-18       | 151    | RU 7759-04       | 157    |
| RU 7630-25 TI    | 126    | RU 7671-21       | 136    | RU 7708-60       | 142    | RU 7752-16       | 151    | RU 7759-05       | 157    |
| RU 7632-27       | 127    | RU 7671-23       | 136    | RU 7708-60 TI    | 142    | RU 7752-16 TI    | 151    | RU 7759-06       | 157    |
| RU 7633-24       | 127    | RU 7671-27       | 136    | RU 7710-18       | 144    | RU 7752-17       | 151    | RU 7759-07       | 157    |
| RU 7634-24       | 127    | RU 7671-31       | 136    | RU 7710-19       | 144    | RU 7752-17 TI    | 151    | RU 7760-20       | 158    |
| RU 7635-25       | 128    | RU 7680-12       | 137    | RU 7711-24       | 144    | RU 7754-01       | 152    | RU 7760-25       | 158    |
| RU 7636-26       | 128    | RU 7680-14       | 137    | RU 7711-26       | 144    | RU 7754-02       | 152    | RU 7760-30       | 158    |
| RU 7636-26 TI    | 128    | RU 7680-16       | 137    | RU 7711-28       | 144    | RU 7754-03       | 152    | RU 7760-40       | 158    |
| RU 7638-01       | 128    | RU 7680-18       | 137    | RU 7711-30       | 144    | RU 7754-04       | 152    | RU 7760-45       | 158    |
| RU 7638-02       | 128    | RU 7680-20       | 137    | RU 7711-32       | 144    | RU 7754-05       | 152    | RU 7760-50       | 158    |
| RU 7640-00       | 129    | RU 7681-12       | 137    | RU 7711-36       | 144    | RU 7754-10       | 153    | RU 7760-72       | 158    |
| RU 7640-00 TI    | 129    | RU 7681-14       | 137    | RU 7715-40       | 145    | RU 7754-11       | 153    | RU 7760-74       | 158    |
| RU 7640-20       | 129    | RU 7681-16       | 137    | RU 7715-41       | 145    | RU 7754-12       | 153    | RU 7760-76       | 158    |
| RU 7640-20 TI    | 129    | RU 7681-18       | 137    | RU 7715-42       | 145    | RU 7754-14       | 153    | RU 7761-00       | 62     |
| RU 7640-25       | 129    | RU 7681-20       | 137    | RU 7715-43       | 145    | RU 7754-15       | 153    | RU 7763-00       | 62     |
| RU 7640-25 TI    | 129    | RU 7682-16       | 138    | RU 7715-45       | 145    | RU 7754-18       | 153    | RU 7765-03       | 62     |
| RU 7640-26       | 129    | RU 7683-16       | 138    | RU 7715-46       | 145    | RU 7755-01       | 154    | RU 7765-04       | 62     |
| RU 7640-26 TI    | 129    | RU 7685-15       | 138    | RU 7715-47       | 145    | RU 7755-02       | 154    | RU 7765-05       | 62     |
| RU 7640-27       | 129    | RU 7685-16       | 138    | RU 7715-48       | 145    | RU 7755-03       | 154    | RU 7765-06       | 62     |
| RU 7640-27 TI    | 129    | RU 7687-15       | 138    | RU 7715-50       | 145    | RU 7755-04       | 154    | RU 7765-13       | 62     |
| RU 7640-28       | 129    | RU 7688-17       | 138    | RU 7715-52       | 145    | RU 7755-05       | 154    | RU 7765-14       | 62     |
| RU 7640-28 TI    | 129    | RU 7689-17       | 138    | RU 7715-54       | 145    | RU 7755-06       | 154    | RU 7765-15       | 62     |
| RU 7646-01       | 129    | RU 7690-17       | 138    | RU 7715-56       | 145    | RU 7755-07       | 154    | RU 7765-16       | 62     |
| RU 7646-02       | 129    | RU 7691-17       | 138    | RU 7715-60       | 145    | RU 7755-08       | 154    | RU 7770-05       | 63     |
| RU 7647-21       | 130    | RU 7692-16       | 138    | RU 7715-62       | 145    | RU 7755-09       | 154    | RU 7770-10       | 63     |
| RU 7647-21 TI    | 130    | RU 7692-17       | 138    | RU 7715-64       | 145    | RU 7755-11       | 155    | RU 7770-15       | 63     |
| RU 7648-21       | 130    | RU 7694-01       | 139    | RU 7715-66       | 145    | RU 7755-12       | 155    | RU 7770-20       | 63     |
| RU 7648-21 TI    | 130    | RU 7694-01 TI    | 139    | RU 7721-17       | 146    | RU 7755-13       | 155    | RU 7770-25       | 63     |
| RU 7649-17       | 130    | RU 7694-02       | 139    | RU 7721-17 TI    | 146    | RU 7755-14       | 155    | RU 7770-30       | 63     |
| RU 7650-17       | 130    | RU 7694-02 TI    | 139    | RU 7722-17       | 146    | RU 7755-15       | 155    | RU 7770-35       | 63     |
| RU 7650-17 TI    | 130    | RU 7694-03       | 139    | RU 7722-17 TI    | 146    | RU 7755-16       | 155    | RU 7770-40       | 63     |
| RU 7651-16       | 131    | RU 7694-03 TI    | 139    | RU 7723-17       | 146    | RU 7755-17       | 155    | RU 7770-45       | 63     |
| RU 7651-16 TI    | 131    | RU 7695-41       | 139    | RU 7723-17 TI    | 146    | RU 7755-18       | 155    | RU 7770-50       | 63     |
| RU 7653-01       | 131    | RU 7695-42       | 139    | RU 7724-17       | 146    | RU 7755-19       | 155    | RU 7770-70       | 63     |
| RU 7653-02       | 131    | RU 7695-43       | 139    | RU 7724-17 TI    | 146    | RU 7756-01       | 154    | RU 7770-90       | 63     |
| RU 7654-20       | 131    | RU 7698-14       | 139    | RU 7726-18       | 147    | RU 7756-02       | 154    | RU 7771-05       | 63     |
| RU 7657-00       | 132    | RU 7698-16       | 139    | RU 7726-18 TI    | 147    | RU 7756-03       | 154    | RU 7771-10       | 63     |
| RU 7657-15       | 132    | RU 7698-18       | 139    | RU 7726-20       | 147    | RU 7756-04       | 154    | RU 7771-15       | 63     |



Nummernverzeichnis  
Numerical index  
Indice numérico  
Table numérique  
Indice numerico

Katalog-Nr..... Seite  
Cat. no.....page  
No. ref. ....página  
No. réf. ....page  
No. rif..... pagina

RU 7771-20 ..... 63  
RU 7771-25 ..... 63  
RU 7771-30 ..... 63  
RU 7771-35 ..... 63  
RU 7771-40 ..... 63  
RU 7771-45 ..... 63  
RU 7771-50 ..... 63  
RU 7771-70 ..... 63  
RU 7771-90 ..... 63  
RU 7773-00 ..... 64  
RU 7773-02 ..... 64  
RU 7773-04 ..... 64  
RU 7773-06 ..... 64  
RU 7773-08 ..... 64  
RU 7773-10 ..... 64  
RU 7773-12 ..... 64  
RU 7773-14 ..... 64  
RU 7773-16 ..... 64  
RU 7773-18 ..... 64  
RU 7773-20 ..... 64  
RU 7773-22 ..... 64  
RU 7773-24 ..... 64  
RU 7773-26 ..... 64  
RU 7773-28 ..... 64  
RU 7773-30 ..... 64  
RU 7773-32 ..... 64  
RU 7773-34 ..... 64  
RU 7773-36 ..... 64  
RU 7773-38 ..... 64  
RU 7773-98 ..... 64  
RU 7773-99 ..... 64  
RU 7780-01 ..... 66  
RU 7780-02 ..... 66  
RU 7780-03 ..... 66  
RU 7780-04 ..... 66  
RU 7780-05 ..... 66  
RU 7787-32 ..... 66  
RU 7787-64 ..... 66  
RU 8204-16 ..... 61  
RU 8216-18 ..... 60  
RU 8825-07 ..... 61  
RU 8825-08 ..... 61  
RU 8825-09 ..... 61  
RU 8850-01 ..... 61  
RU 8850-02 ..... 61  
RU 8916-11 ..... 160  
RU 8917-01 ..... 160









RUDOLF MEDICAL GmbH + Co. KG

Zollerstraße 1 · 78567 Fridingen, Germany · Phone +49 (74 63) 99 56-0  
Fax +49 (74 63) 99 56-56 · mail@rudolf-med.com · www.rudolf-med.com

**rudolf**<sup>®</sup>  
MEDICAL